

HIGH QUALITY VEHICLE TECHNOLOGY

FOR MOTORHOMES, VANS & CARAVANS

- Innovative, state-of-the-art technologies
- High-quality workmanship guarantees reliability and durability
- Tested and recommended by professionals for years
- Attractive price-performance ratio with 3 or 7-year warranty



QUALITY & RELIABILITY FOR MORE THAN 23 YEARS.

The CARBEST brand from REIMO has stood for high-quality technical products for motorhomes, vans and caravans since 2000.

Extensive testing in the development department in Germany by our engineers, technicians and experienced camping professionals ensure that the quality of CARBEST products and their functions are ideal for mobile use in vehicles.

When it comes to the quality and functions of all products, special attention is paid to ensuring that they are not only fun to use when camping, but also meet the high demands of the components used in motorhome production. Chargers, LED lights, LiFePO4 batteries and satellite systems are now used by many manufacturers as original equipment.

You can also find the entire CARBEST range in our extensive online store at www.carbest.de

Find your desired product quickly:

Enter the article number in the search, order the item and collect it from your local specialist dealer or have it conveniently delivered to your home.



Click here to go to the Online shop www.carbest.de



MORE THAN JUST A GOOD FEELING: 3 OR 7 YEARS WARRANTY ON THE CARBEST PRODUCTS!

As a specialist in the camping segment, we also offer a huge range of camping accessories and high-quality technical products under our CARBEST brand.

To underline the high product quality standards of our CARBEST products, we offer a 3-year warranty, on selected products even a 7-year warranty.

(* Our warranty conditions can be found on catalogue page 114)

www.carbest.de

CONTENT

Flexible solar modules	4 – 5	Pipe system for fresh water	52
Flexible solar module complete sets	6	Vehicle windows made of safety glass	54 – 59
Rigid solar modules	7	Acrylic car window	59 – 65
Rigid solar module complete sets	8 – 9	Roof hoods/protective covers	66 – 68
Foldable solar panels/solar accessories	10 – 13	Roof ventilation systems	69
Multifunctional power stations	14 – 15	Thermal mats	70 – 74
LiFePO4 batteries	16 – 17	Exterior insulation	75 – 77
AGM batteries/Energy station/ Battery terminal accessories	18 – 19	Mosquito nets	78 – 81
Battery chargers/charging boosters	20 – 21	Autolift leveling systems	82
Sine Power Inverter	22 – 23	Air suspension systems	83
Sinusoidal inverters	24	Maneuvering systems/trailer electrics	84 – 85
12/24 V modules/power distribution	25	CEE plugs, cables, cable drums	86 – 87
12 V charging sockets/USB charging plugs	26	Schuko accessories for 230 V	88
Compressor coolers	27 – 31	Gas alarms/smoke detectors	89
Pull-out rails for cool boxes	32	Line lights	90
Compressor built-in refrigerators	33 – 35	Panel lights/awning lights	91
Air conditioners	36	Luminaires	92 – 93
Diesel parking heaters	37	Recessed lights/cockpit lights	94 – 95
Smart TVs	38	LED strips/aluminum profiles	96 – 97
TV wall mounts	39	SMD/COB light source	98
Satellite systems/antenna masts	40 – 43	Outdoor lights	98 – 99
Rear view mirror cameras	44	Vehicle insulation/vehicle protection	100 – 101
Brake light cameras/ Radio rear view camera system	45	Vehicle mats / floor mats	102 – 103
Gas hobs	46 – 47	Protective covers/Utensilos	104
Hob/sink combinations	48 – 49	Extra beds / lift bed	105
Sinks	49 – 50	Levelling wedges/steps	106 – 107
Water pumps	51	Caravan accessories	108 – 109
		Practical camping accessories	110 – 112
		Conversion products	113

NOVELTY HIGHLIGHTS



POWER PANEL SFX135 SOLAR MODULE

EXTREMELY ROBUST WITH ETFE COATING

135 WATT	EXTREME ROBUST	FIBER-GLASS CARRIER-PLATE	SUN POWER CELLS	ETFE-COVERED	6 m CABLE 2x 2,5 mm²
-----------------	-----------------------	----------------------------------	------------------------	---------------------	--

- Very resistant thanks to ETFE front and back foil with welded outer edges
- SUNPOWER high performance cells
- Compact connection box
- 6 m cable (2 x 2.5 mm²) pre-installed

The 135 W Power Panel SFX135 is a semi-flexible solar module with a new material composition. The SUNPOWER high-performance cells are mounted on a stable, black fiberglass carrier plate, which is covered by an extremely resistant ETFE layer. This ETFE film is on both the front and back of the module and is welded together at the edge.

This design ensures optimal protection of the internal cells and makes the Power Panel SFX135 extremely robust against scratches, heat, high humidity as well as sea and salt water.

Power / Sunpower cell count	135 W/36 cells
Material top layer front and back	ETFE
Material carrier plate	Fiberglass (black)
Cell efficiency	24,40 %
Short circuit current (Isc)	6,42 A
Open circuit voltage (Voc)	26.2 Volt
Rated voltage (Vmp)	22,3 Volt
Rated current (Imp)	6,06 A
Dims. mm LxWxH (height connection box)	1235 x 540 x 4 (approx. 22)
Cable (2 x 2.5mm ²)	6 m
Weight incl. cable	approx. 4.7 kg
Item no.	84031
Price	449,-



Fiberglass Sheet, ETFE Jacketed



SUNPOWER cells



Compact connection box (H: 22 mm)



6m connection cable pre-assembled

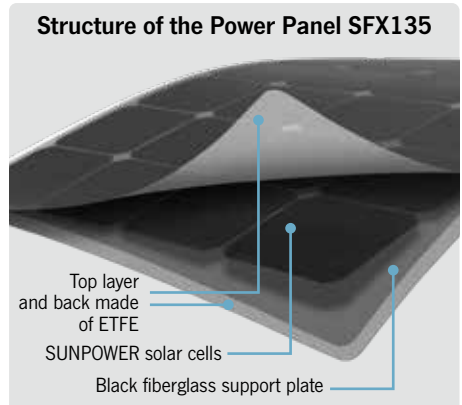

POWER PANEL SFX135 COMPLETE SET

135 WATT	INCL. MPPT CHARGE CONTROLLER	6 m CABLE 2x 2,5 mm²
-----------------	-------------------------------------	--

- Set includes solar module SFX135 with pre-installed cable (length 6 m), high-quality MPPT charge controller, roof bushing
- MPPT solar controller (12V/12A, max. 165W) for charging GEL, lead-acid, AGM and LiFePO4 batteries (battery type adjustable)

Solar panel	1 x 84031
Dims. mm LxWxH (Box H)	1235x540x4 (app. 22)
Cable (2 x 2.5mm ²)	6 m
MPPT solar charge controller	851005
Controller power	12V/12A, max. 165 W
Cable gland	85258
Item no.	85279
Price	549,-

Including MPPT solar charge controller, roof cable entry and solar cable



Optional accessories



Optional accessories:

- ① **Bluetooth module for MPPT solar charge controller 851005**
Display of relevant solar data on the smartphone via Bluetooth.
Cable length: 3 m. **851007 29,90**
- ② **Temperature sensor with 3 m cable**
851004 10,30

POWER PANEL FLEX SOLAR MODULES

- ETFE SURFACE
- FIBERGLASS OR TPT CARRIER PLATE
- SUN POWER CELLS
- ONLY 3 mm THICK
- INCL. CABLE 2x 2,5 mm²

- Sunpower cells: Significant increase in electricity yield even if angle to sun is not optimal
- Approx. 5x lighter than conventional modules
- Compact connection box
- Solar cable (2 x 2.5 mm²) pre-installed
- Compatible with solar controllers from CARBEST or VOTRONIC
- Also ideal for maritime use

The solar modules deliver more power than conventional PV modules of the same size. Thanks to high-quality ETFE surface with honeycomb structure, there is significant performance increase in twilight/cloudy conditions.

Especially at high temperatures, the performance is significantly higher than comparable modules. This means maximum efficiency without any loss of performance.

Material top layer:

ETFE: Very hard & thin (app. 0.025 mm) material with high light transmission of app. 95%. Heat resistant up to app. 150°C. Very high weather resistance, also suitable for salt water.

Material carrier plate:

TPT: Material with high bending capacity. More flexible than fiberglass.

Fiberglass: Very strong, hard material for the best possible protection of the solar cells.

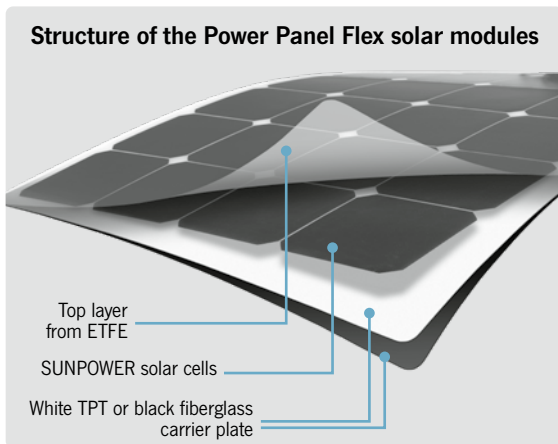

	Power Panel Flex 80 white*	Power Panel Flex 110 Pro black	Power Panel Flex 110 white	Power Panel Flex 125 Pro Square black	Power Panel Flex 135 Square white*	Power Panel Flex 150 Pro black*	Power Panel Flex 165 white* rear connection box
Power / Number of cells	80 W/56 cells	110 W/32 cells	110 W/32 cells	125 W/36 cells	135 W/36 cells	150 W/44 cells	165 W/44 cells
Material top layer	ETFE	ETFE	ETFE	ETFE	ETFE	ETFE	ETFE
Material carrier plate	TPT	Fiberglass	TPT	Fiberglass	TPT	Fiberglass	TPT
Cell efficiency	20,8 %	22,5 %	22,6 %	22,5 %	24,4 %	24,4 %	24,40 %
Short circuit current (Isc)	2,8 A	6,88 A	6,32 A	6,94 A	6,41 A	6,41 A	6,41 A
Open circuit voltage (Voc)	36,5 Volt	20,77 Volt	21,9 Volt	23,36 Volt	26,2 Volt	29,2 Volt	32,1 Volt
Rated voltage (Vmp)	30,8 Volt	17,6 Volt	18,6 Volt	19,8 Volt	22,3 Volt	24,8 Volt	27,3 Volt
Rated current (Imp)	2,6 A	6,25 A	5,97 A	6,31 A	6,05 A	6,05 A	6,05 A
Dims. mm LxWxH (Box H)	980 x 550 x 3 (22)	1100 x 540 x 2,5 (22)	1095x540x3 (22)	840x800x2,5 (22)	860 x 800 x 3 (22)	1360 x 540 x 3 (22)	1460 x 540 x 3 (22)
Cable (2 x 2.5mm ²)	8 m	6 m	8 m	6 m	8 m	6 m	6 m
Weight incl. cable	app. 2.1 kg	app. 4.0 kg	app. 3,2 kg	app. 4,3 kg	app. 3.9 kg	app. 5 kg	app. 4,8 kg
Item no.	85319	853180	853170	853181	853175	853176	853177
Price	186,15	459,-	259,-	399,-	399,-	469,-	449,-

*We recommend an MPPT solar charge controller with an input voltage >30 V for these modules to make optimal use of the power.

POWER PANEL FLEX COMPLETE SETS

POWER
PANEL
MODULES

SUN
POWER
CELLS

INCL. MPPT
CHARGE
CONTROLLER

INCL.
CABLE
2x 2,5
mm²

ALL SETS INCLUDING SOLAR
CONTROLLER, ROOF CABLE
ENTRY
AND SOLAR CABLE

- Power from 80 to 160 watts
- Sets include solar panel with pre-installed cable, high quality MPPT solar controller & roof cable entry
- MPPT solar controller for charging GEL, lead-acid, AGM & LiFePO4 batteries (battery type adjustable)

Complete set Power Panel Flex 80 white

Ideal for low energy requirements, e.g. for lights and water pumps or for charging smartphones/tablets, battery packs or cameras. Suitable also for battery conservation and compensation of silent consumers.

Complete set Power Panel Flex 110-135 white or black

Set with the CARBEST solar module 110W or 125W or 135 W e.g. for light, water pump, compressor cooler, occasional heating.

Complete set Power Panel Flex 150/160 white or black

Set with the CARBEST 150/160 W solar module, e.g. for light, pump, TV/Sat, heating and compressor refrigerator.



Ideal for vans and motorhomes. Ensures consistent driving behavior.

MPPT solar charge controller
(851005/851006)

	Complete set Power Panel Flex 80 white	Complete set Power Panel Flex 110 Pro black	Complete set Power Panel Flex 110 white	Complete set Power Panel Flex 125 Pro Square black	Complete set Power Panel Flex 135 Square white	Complete set Power Panel Flex 150 Pro black	Complete set Power Panel Flex 165 white (rear connection box)
Solar panel power	80 W	110 W	110 W	125 W	135 W	150 W	165 W
Solar panel	1 x 85319	1 x 853180	1 x 853170	1 x 853173	1 x 853175	1x 853176	1x 853177
Dims. mm LxWxH (Box H)	980 x 550 x 3 (22)	1100 x 540 x 2,5 (22)	1095x540x3 (22)	840x800x2,5 (22)	860 x 800 x 3 (22)	1475 x 540 x 3 (22)	1460 x 540 x 3 (22)
Cable (2 x 2.5 mm ²)	8 m	6 m	8 m	8 m	8 m	6m	6m
MPPT solar charge controller	851005	851005	851005	851005	851005	851005	851006
Controller power	12V/12A, max. 165 W	12V/12A, max. 165 W	12V/12A, max. 165 W	12V/12A, max. 165 W	12V/12A, max. 165 W	12V/12A, max. 165 W	12V/25A, max. 350 W
Cable gland	85201	85201	85201	85201	85201	85201	85201
Item no.	85270	85269	85272	85273	85277	85278	85276
Price	299,-	519,-	369,-	439,-	469,-	599,-	529,-

Optional accessories:

① Bluetooth module for MPPT solar charge controller 851005/851006

Display of relevant solar data on the smartphone via Bluetooth.
Cable length: 3 m. **851007 29,90**

② Temperature sensor with 3 m cable **851004 10,30**



SOLAR MODULES WITH SHINGLE CELL TECHNOLOGY: MORE POWER WITH THE SAME SURFACE AREA

- BLACK ALUMINIUM FRAME
- FUSE GLASS
- SHINGLE CELLS TECHNOLOGY
- MONO CELLS
- INCL. CABLE 2x 2,5 mm²
- COLOUR BLACK

State-of-the-art shingle cell technology:

Narrow, overlapping cell strips without gaps instead of conventional, adjacent individual cells. This special design reduces power losses and increases the module output.

- More power in the same space
- Less power loss with partial shading
- 10% higher surface efficiency compared to standard solar cells
- Robust aluminum frame (black)

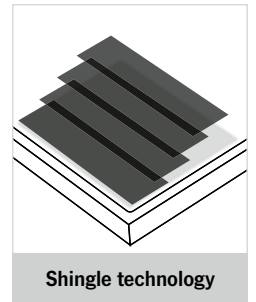

	CBS-120 Shingle	CBS-150 Shingle
Power / Cell type	120 W / shingle technology	150 W / shingle technology
Cell efficiency	22,70 %	22,70 %
Short circuit current (Isc)	6,28 A	6,24 A
Open circuit voltage (Voc)	24 V	30,1 V
Rated voltage (Vmp)	20,3 V	25,5 V
Rated current (Imp)	5,92 A	5,89 A
Operating temperature	-40°C ~ +85°C	-40°C ~ +85°C
Dims. in mm LxWxH	1165x540x35	1450x540x35
Cable (2x 2,5,mm ²)	6 m	6 m
Weight	app. 7 kg	app. 9.5 kg
Colour	Black	Black
Item no.	8523899	8523900
Price	219,-	269,-

CB + FULL-BLACK SOLAR MODULES

- ALU-MINIUM FRAME
- FUSE GLASS
- MONO CELLS
- INCL. CABLE 2x 2,5 mm²

TOTAL 8 MODULES FOR SELECTION

- Power: 115 to 190 watts
- All solar modules with solid aluminum frame (CB series: colour silver / Full-Black series: colour black)
- Monocrystalline cells under annealed glass
- Protected cable connection (2x 2.5mm²)
- 25 years performance warranty (After 25 years still approx. 80% performance)*

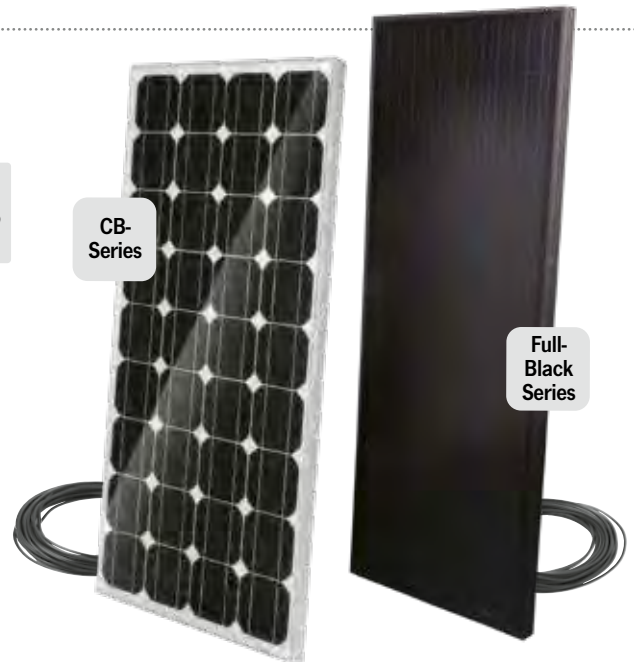

	CB-115 Slim (slim design)	CB-115	CB-155	CB-170	115W Full-Black	155W Full-Black	170W Full-Black	190W Full-Black
Power	115 W	115 W	155 W	170 W	115 W	155 W	170 W	190 W
Cell count	32 cells	36 cells	36 cells	36 cells	36 cells	36 cells	36 cells	35 cells
Efficiency of cells	23,0%	22,0%	22,0%	22,0%	22,4%	22,4%	22,4%	22,40%
Short circuit current (Isc)	6,92 A	6,16 A	8,3 A	9,02 A	6,27 A	8,45 A	9,03 A	10,46 A
Open circuit voltage (Voc)	21,33 Volt	23,96 Volt	23,96 Volt	24,18 Volt	23,52 Volt	23,52 Volt	24,16 Volt	23,31 Volt
Rated voltage (Vmp)	17,62 Volt	19,80 Volt	19,8 Volt	19,85 Volt	19,43 Volt	19,43 Volt	19,80 Volt	19,26 Volt
Rated current (Imp)	6,53 A	5,81 A	7,83 A	8,56 A	5,92 A	7,98 A	8,59 A	9,87 A
Dims. in mm LxWxH	1580x410x35	1200x545x35	1640x545x35	1755x545x35	1200x545x35	1640x545x35	1755x545x35	1175x840x35
Cable (2x 2.5 mm ²)	6m	1m	6m	6m	1m	6m	6m	6m
Weight app.	7,5 kg	7,5 kg	10,5 kg	11,3 kg	7,5 kg	10,5 kg	11,3 kg	11,8 kg
Item no.	852387	852380	852389	852391	852381	852390	852392	852393
Price	219,-	175,-	289,-	309,-	314,-	314,-	329,-	349,-

* Please note our warranty conditions on page 114.

CB SOLAR MODULE COMPLETE SETS

ALU-MINIUM FRAME SILVER

FUSE GLASS

MONO CELLS

INCL. CABLE 2x 2,5 mm²

ALL SETS INCL. MOUNTING BRACKET, CHARGE CONTROLLER, ROOF CABLE ENTRY AND SOLAR CABLE

- Power: 115 to 310 watts
- Sets include solar panel with mounting spoiler, roof cable entry, MPPT solar charge controller and solar cable
(All sets with MPPT solar charge controller except starter set)
- MPPT solar charge controller for charging GEL, lead-acid, AGM and LiFePO4 batteries (battery type adjustable)
- Monocrystalline cells
- Solid aluminum frame, silver colour
- Tempered glass
- With pre-installed connection cable (2x 2.5 mm²)
- 25-year performance guarantee
(After 25 years still approx. 80% performance)*

All sets include MPPT solar charge controller (except for starter set) mounting spoiler, roof cable entry and solar cable



	Complete starter set CB-115B (without MPPT solar charge controller)	Complete set CB-115 Slim	Complete set CB-115	Complete set CB-155	Complete set CB-170	Complete set CB-230	Complete set CB-310
Solar panel power	1x 115 W	1x 115 W	1x 115 W	1x 155 W	1x 170 W	2x 115 W	2x 155 W
Solar panel	1x 852380	1x 852387	1x 852380	1x 852389	1x 852391	2x 852380	2x 852389
Dims. in mm LxWxH	1200x545x35	1580x410x35	1200x545x35	1640x545x35	1755x545x35	2x 1200x545x35	2x 1640x545x35
Solar charge controller	85135	851005	851005	851005	851006	851006	851006
Controller power	12V/15A, max. 180 W	12V/12A, max. 165 W	12V/12A, max. 165 W	12V/12A, max. 165 W	12V/25A, max. 350 W	12V/25A, max. 350 W	12V/25A, max. 350 W
Cable (2x 2.5 mm ²)	10 m	6 m	10 m	6 m	6 m	10 m	6 m
Cable gland (white)	85049	85049	85049	85049	85049	850491	850491
Mounting spoiler (white)	850906	850900	850906	850906	850906	2x 850906	2x 850906
Item no.	851095	851080	851096	851100	851101	851077	851102
Price	249,-	319,-	289,-	399,-	419,-	519,-	699,-

* Please note our warranty conditions on page 114.

Optional accessories:

- ① Bluetooth module for MPPT solar charge controller 851005/851006
Display of relevant solar data on the smartphone via Bluetooth.
Cable length: 3 m. **851007 29,90**
- ② Temperature sensor with 3 m cable **851004 10,30**



FULL-BLACK SOLAR MODULE-COMplete SETS

ALU-MINIUM FRAME BLACK

FUSE GLASS

MONO CELLS

INCL. CABLE 2x 2,5 mm²

ALL SETS INCL. MOUNTING BRACKET, CHARGE CONTROLLER, ROOF CABLE ENTRY AND SOLAR CABLE

Output: 115 to 190 watts

- Sets include solar panel with mounting spoiler, roof cable entry, MPPT solar charge controller and solar cable
- MPPT solar charge controller for charging GEL, lead-acid, AGM and LiFePO4 batteries (battery type adjustable)
- Monocrystalline cells
- Solid aluminum frame, colour black
- With pre-installed connection cable (2x 2.5mm²)
- 25-year performance guarantee (After 25 years still approx. 80% power)*

All sets include MPPT solar charge controller (except for starter set) mounting spoiler, roof cable entry and solar cable



MPPT solar charge controller (851005/851006)



	Complete set 115W Full-Black	Complete set 155W Full-Black	Complete set 170W Full-Black	Complete set 190W Full-Black
Solar panel power	1x 115 W	1x 155 W	1x 170 W	1x 190 W
Solar panel	1x 852381	1x 852390	1x 852392	1x 852393
Dims. in mm LxWxH	1200x545x35	1640x545x35	1755x545x35	1175x840x35
MPPT solar charge controller	851005	851005	851006	851006
Controller power	12V/12A, max. 165 W	12V/12A, max. 165 W	12V/25A, max. 350 W	12V/25A, max. 350 W
Cable (2x 2.5 mm ²)	10 m	6 m	6 m	6 m
Cable grommet (black)	850493	850493	850493	850493
Mounting spoiler (black)	850909	850909	850909	850911
Item no.	851103	851104	851105	851106
Price	369,-	399,-	419,-	479,-

* Please note our warranty conditions on page 114.

Optional accessories:

① Bluetooth module for MPPT solar charge controller 851005/851006

Display of relevant solar data on the smartphone via Bluetooth.

Cable length: 3 m.

851007 29,90

② Temperature sensor with 3 m cable

851004 10,30



MOBILE, FOLDABLE SOLAR SYSTEMS



Foldable Power Solar Panel SC100

- 100 WATT
- SHINGLE PERC CELLS
- MONO-CRISTAL-LINE CELLS
- ETFE TOP-AREA
- 3x USB
- PROTECTION-BAG

- High performance solar module with shingle cell technology - More power on the same area, less loss with partial shading
- ETFE surface: Very robust with high light transmission
- Suitable for standing or hanging
- Integrated bag with cable connection and 3x USB
- 1x USB-A (5V/3A max.)
 - 1x USB-QC 3.0 (5V/3A, 9V/2A, 12V/1.5A max.)
 - 1x USB-C PD 3.0 (5V/3A, 9V/3A, 12V/3A, 15V/3A, 20V/3A max.)
- Including 2 cables for connection to portable energy systems/power units*:
 - 5m extension cable (2x 2.5 mm²) with Anderson Mini on both sides
 - 1m adapter cable (2x 2.5 mm²) with Anderson Mini/Anderson 50 A
- Additional protective bag with attached pocket for storage of the connection cables
- Please order solar charge controller separately (see page 12)

Power	100 watt
Cell type	Monocrystalline cells
Rated voltage (Vmp)/rated current (Imp)	19.4 V / 5.16 A
Open circuit voltage (Voc)	22,9 V
Short circuit current (Isc)	5,46 A
Max. System voltage (V)	100 VDC
Cell efficiency	22 %
Dims. open in mm	1100x615x16
Dims. closed in mm	615x550x32
Weight incl. acc. app.	4,5 kg
Item no.	82510
Price	299,-

Foldable Power Solar Panel SC200

- 200 WATT
- SHINGLE PERC CELLS
- MONO-CRISTAL-LINE CELLS
- ETFE TOP-AREA
- 3x USB
- PROTECTION-BAG

- High performance solar module with shingle cell technology - More power on the same area, less loss with partial shading
- ETFE surface: Very robust with high light transmission
- Suitable for standing or hanging
- Integrated bag with cable connection and 3x USB
- 1x USB-A (5V/3A max.)
 - 1x USB-QC 3.0 (5V/3A, 9V/2A, 12V/1.5A max.)
 - 1x USB-C PD 3.0 (5V/3A, 9V/3A, 12V/3A, 15V/3A, 20V/3A max.)
- Includes 2 cables for connection to portable energy systems/power units*:
 - 5m extension cable (2x 4 mm²) with Anderson Mini on both sides
 - 1m adapter cable (2x 4 mm²) with Anderson Mini/Anderson 50 A
- Additional protective bag with attached pocket for storage of the connection cables
- Please order solar charge controller separately (see page 12)

Power	200 watt
Cell type	Monocrystalline cells
Rated voltage (Vmp)/rated current (Imp)	19.4 V / 10.31 A
Open circuit voltage (Voc)	22,9 V
Short circuit current (Isc)	10,93 A
Max. System voltage (V)	100 VDC
Cell efficiency	22 %
Dims. open in mm	2040x615x16
Dims. closed in mm	615x550x32
Weight incl. acc. app.	7,5 kg
Item no.	82509
Price	599,-

* The foldable Power Solar Panels SC100 / SC200 / HC130 are supplied without a solar charge controller.

If a solar charge controller of suitable power is already installed in a portable energy system (power unit / power station), no separate solar charge controller is required. If connected to a car battery or a portable energy system (Power Unit / Powerstation) without an integrated solar charge controller, a solar charge controller of suitable capacity and a fuse must be connected.



Foldable Power Solar Panel HC130 (solar case)

130 WATT

MONO-CRISTAL-LINE CELLS

ETFE TOP-AREA

BLACK DESIGN

PROTECTION-BAG

- High quality monocrystalline cells
- Narrow aluminum frame with edge protection corners
- ETFE surface: Very robust with high light transmission
- All black design
- Fold out feet for standing
- Includes 2 cables for connection to portable Energy systems/power units*:
 - 5m extension cable (2x 2.5 mm²) with Anderson Mini on both sides
 - 1m adapter cable (2x 2.5 mm²) with Anderson Mini/Anderson 50 A
- Additional protective bag with attached pocket for storage of the connection cables
- Please order solar charge controller separately (see page 12)

Power	130 watt
Cell type	Monocrystalline cells
Rated voltage (Vmp)/rated current (Imp)	20.5 V / 6.35 A
Open circuit voltage (Voc)	24 V
Short circuit current (Isc)	6,66 A
Max. System voltage (V)	100 V DC
Cell efficiency	22,70 %
Dims. open in mm	1193x635x25
Dims. closed in mm	595x635x50
Colour	Black
Weight app.	7,5 kg
Item no.	82508
Price	399,--

OPTIONAL ACCESSORIES

FOR ALL SOLAR SYSTEMS ON THIS DOUBLE PAGE

Pre-assembled cable sets for connection of a solar charge controller (Solar charge controller not included)

① Connection cable XT60

Adapter cable for connection to a lithium energy system with XT60 connection (e.g. Ecoflow). Anderson Mini / XT60.

Cable length: 1m, (2x 2.5mm²).

850923 19,90



Adapter cable Ecoflow

② Cable set with battery terminals

Cable 1: Battery terminals with fuse / open cable end. Cable length: 1m, (2x 2.5mm²).

Cable 2: Anderson Mini / open cable end. Cable length: 40 cm, (2x 2.5mm²).

850924 25,70

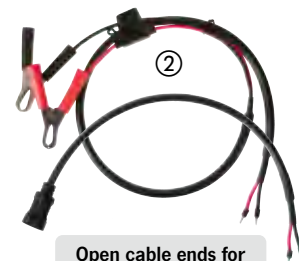

Open cable ends for connection to a solar charge controller

③ Cable set with cigarette lighter plug

Cable 1: Cigarette lighter plug with integrated fuse / open cable end. Cable length: 1m, (2x 2.5mm²).

Cable 2: Anderson Mini / open cable end. Cable length: 40 cm, (2x 2.5mm²).

850925 21,90

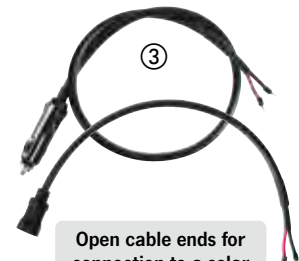

Open cable ends for connection to a solar charge controller

④ Cable set with Anderson 50A plug

Cable 1: Anderson 50 A / open cable end. Cable length: 1m, (2x 2.5mm²).

Cable 2: Anderson Mini / open cable end. Cable length: 40 cm, (2x 2.5mm²).

850926 21,90

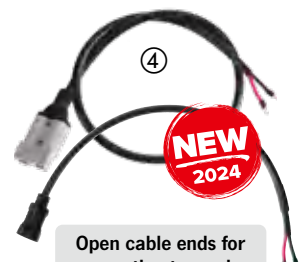

Open cable ends for connection to a solar charge controller

Detailed view of the different plugs (Fig. similar):



Mini Anderson



Anderson 50 A



XT60

* The foldable Power Solar Panels SC100 / SC200 / HC130 are supplied without a solar charge controller.

If a solar charge controller of suitable power is already installed in a portable energy system (power unit / power station), no separate solar charge controller is required. If connected to a car battery or a portable energy system (Power Unit / Powerstation) without an integrated solar charge controller, a solar charge controller of suitable capacity and a fuse must be connected.

MPPT SOLAR CHARGE CONTROLLER AND ACCESSORIES



NEW 2024

12V 24V	MAX. 30 A	12V: MAX. 390 W	24V: MAX. 780 W
MAX. 50 V	BLUE- TOOTH READY	LEAD AGM GEL LiFePO4	ⓔ ECE R10

MPPT solar charge controller 30A with two battery outputs for charging batteries with different voltages (12/24V) or different types (e.g. AGM/LiFePO4)

- Bluetooth function only in conjunction with the optional Bluetooth module 851007 (free app for Android and iOS)
- Battery type adjustable via dip switch: GEL, lead-acid, AGM, LiFePO4 batteries
- Max. Input voltage is 50V
- LED status display
- Optional: Recommended temperature sensor (851004)

Dimensions: LxWxH 155x147x43 mm **851010 169,90**

12V MAX. 55 V BLUE-TOOTH READY LEAD AGM GEL LiFePO4 ⓔ ECE R10



MAX. 12 A

MAX. 165 W

MAX. 25 A

MAX. 350 W

MPPT solar charge controller with two battery outputs

- Bluetooth function only in conjunction with the optional Bluetooth module 851007 (free app for Android and iOS)
- Battery type adjustable: GEL, lead-acid, AGM, LiFePO4 batteries
- Max. Input voltage is 50V
- Optional: Recommended temperature sensor (851004)

Dimensions: LxWxH 150x80x40 mm
12V, 12A max. 165W **851005 69,90**
12V, 25A max. 350W **851006 99,90**

ACCESSORIES FOR SOLAR CHARGE CONTROLLER

851010 / 851005 / 851006



Bluetooth module with 3m cable
851007 29,90



Temperature sensor with 3m cable
851004 10,30



Separate solar monitor, suitable for MPPT solar charge controllers 851005 and 851006. Includes mounting frame and 5m cable with connector.

851008 69,95



NEW 2024

12V 24V	MAX. 20 A	12V: MAX. 260 W	24V: MAX. 520 W
MAX. 55 V	BLUE- TOOTH	IP54	ⓔ ECE R10

MPPT solar charge controller 12/24V - 20A with integrated Bluetooth function

- Bluetooth integrated in the housing, all controller and battery settings via the free app
- Suitable for all battery types (GEL, lead-acid, AGM, LiFePO4)
- Particularly quiet due to fanless design
- LED status display
- Temp. sensor included in scope of delivery (length: 80 mm)

Dimensions: LxWxH 165x108x32 mm, weight: 700 g.
851321 119,90



12V 16A 270W

MPPT solar charge controller 12V, 16A

- 12 V/16 A/max. 270 W
- Adjustable battery type
- For gel, AGM, acid, LiFePO4

2 solar modules connectable, 4-stage charging curve, integrated desulfator. Outputs for 2 batteries, with LED charging indicator lights.

Max. Input voltage 40 V. Dimensions: LxWxH 105x85x50 mm
851320 84,95

PWM SOLAR CHARGE CONTROLLER



LiFePO4 charging characteristic

Solar charge controller 12V, 15A

12 V, solar module output min./max. 30-243 W, max. solar module voltage/current 28 V / 15 A, Charging current max. (Batt.1/2) 14.7 A/ 0.8 A, with LiFePO4 charging characteristic, connection to EBL (optional with 851304)

Dimensions: LxWxH 131x77x40 mm, weight approx. 155 g
85138 86,-



Solar charge controller 12V/24V, 15A

Reliable and inexpensive charge controller for solar systems with 180/360 W charging power. With optical capacity indicator.

85135 29,90

CABLE ENTRY / SPOILER PROFILES / PLUG-IN CONNECTIONS



Cable entries

For safe cable routing through roofs or walls. Small, compact, waterproof. Incl. PG 13.5 cable gland for cable Ø 6-12 mm. to stick.

Colour white

① **single** (L12.0 x W6.5 x H3.8 cm) **85049** **10,95**

② **2-gang** (L12.4 x W9.3 x H3.8 cm) **850491** **12,95**

Colour black

③ **1-fold** (L12.0 x W6.5 x H3.8 cm) **850493** **10,95**

④ **2-fold** (L12.4 x W9.3 x H3.8 cm) **850494** **12,95**

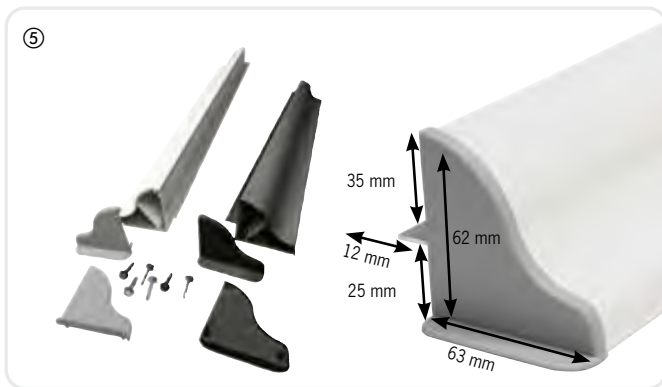

⑤ Aluminum spoiler profile sets

2-part, can be shortened as required, attachment by gluing and / or bolting. Suitable for CARBEST solar modules. Scope of delivery: extruded profile, plastic caps, assembly instructions

Colour white:

2 aluminum profile rods, length 410 mm (suitable for CARBEST module 852387) **850900** **49,95**

2 aluminum profile rods, 550 mm (suitable for CARBEST modules 85226, 85227, 85229, 85239, 85240, 85250) **850906** **56,90**

Colour black:

2 aluminum profile rods, 550 mm (suitable for CARBEST modules 85226, 85227, 85229, 85239, 85240, 85250) **850909** **56,90**

2 aluminum profile bars, 840 mm (suitable for CARBEST module 852393) **850911** **69,90**

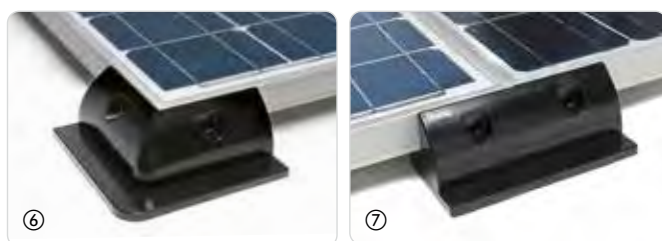

⑥ Corner profile set of 4

Made of ABS plastic, 4 pieces in a set. Dimensions: LxW 150x150 mm **85162** **35,-**

⑦ Connecting profile set of 2

Made of ABS plastic, 2 pieces in a set. Dimensions: L 180 mm **85163** **21,-**

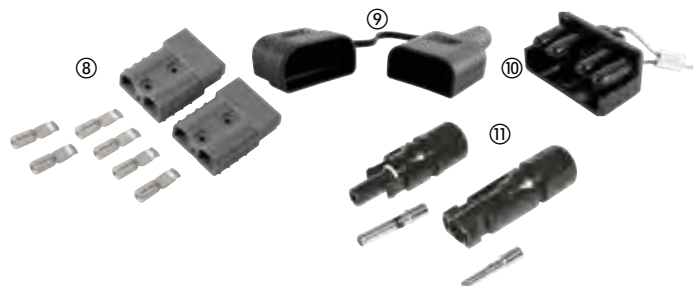

⑧ 50 A high-current battery connector set

2-pole unisex connector that can be used both as a plug and as a socket. Current max. 50 A, including 6 crimp contacts for cable cross-sections from 8mm² to 16mm². Dimensions: LxWxH 48x35x15.9 mm Scope of delivery: 2 x plug connector (set), 6 x crimp contacts. **850920** **7,95**

⑨ Protective cover incl. cap for 50 A connectors

Suitable for no. ⑧. Protects the connector from dust, dirt and splash water. **811215** **2,90**

⑩ Protective cap for 50 A plug

Suitable for no. ⑧. Material: plastic. **811216** **1,99**

⑪ MC4 solar plug set

Special plug set for single-core cables 2.5 - 6mm². With snap-in locking. Set consisting of 1 x plug and 1 x socket. Protection class: unplugged IP2X, plugged IP67. Temperature range -40° to 90° C. Voltage up to max. 1000 V. Current up to max. 30 A. **84052** **4,95**

LITHPOWERUNIT 48



- ① Charging input for solar modules
- ② 12V cigarette lighter connection
- ③ 2x 12V (5.5 mm)
- ④ LCD display
- ⑤ 2x USB (5V/3.1A)
- ⑥ 1x USB QC (5-20V/max. 18W)
- ⑦ 1x USB-C (5-20V/max. 60W)
- ⑧ 2x 230V socket

- Rechargeable via different sources
- Wide range of connection options for various end users
- Small, handy, mobile use
- Perfect for outdoor activities of all kinds

LiFePO4 battery with BMS	48 Ah (12.8 V), 614 Wh
Integrated sine wave inverter	500 W (max. 1000 W for short periods)
Integrated MPPT solar charge controller	max. 120 W / 26 V
Connection options	2x 230 V socket outlet (on the back) 2x 12 V 5.5 mm (5 A, max. 60 W) 1x 12 V cigarette lighter connection (10 A, max. 120 W) 2x USB (5 V/3.1 A) 1x USB QC (5-20 A, max. 18 W) 1x USB-C (5-20 A, max. 60 W)
Rechargeable via	- 230 V mains supply via charger - 12 V vehicle electrical system - Solar module (solar module voltage max. 120 W / 26 V)
Dims. LxWxH app.	324x198x186/254 mm
Weight	8 kg
Item no.	814135
Price	639,-



12V cigarette lighter socket



2x 230V sockets



USB-C port



3x USB port

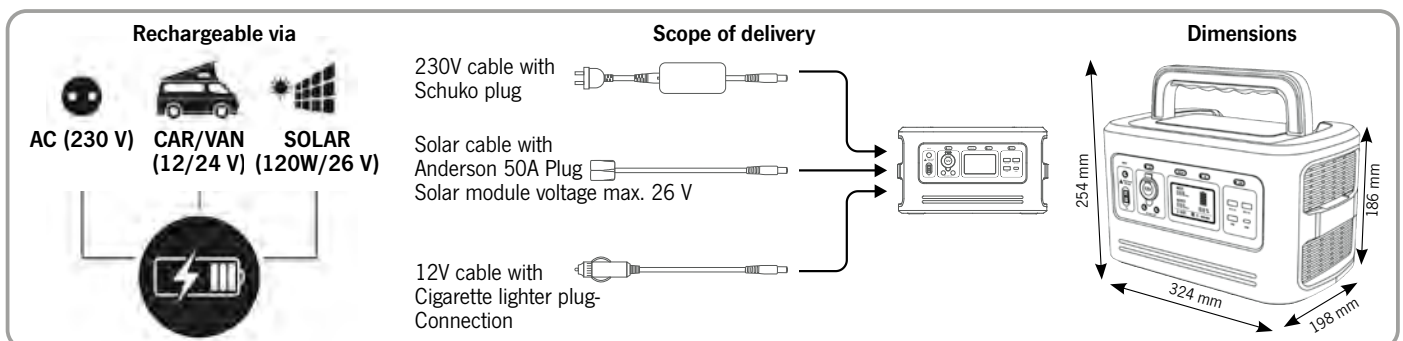

LITHPOWERUNIT 80

80 Ah
LiFePO4
BATTERY

1024
Wh

SINE WAVE
INVERTER
1000 W

MPPT
SOLAR-
CON-
TROLLER

BATTERY
MANAGE-
MENT
SYSTEM

LCD-
DISPLAY

PORTA-
BLE

ROBUST
HOUSING
OFF ABS



LITHPOWERUNIT 120

120 Ah
LiFePO4
BATTERY

1536
Wh

SINE WAVE
INVERTER
2500 W

MPPT
SOLAR-
CON-
TROLLER

CHARGING
BOOSTER
(30 A)

BATTERY
MANAGE-
MENT
SYSTEM

RCD
CIRCUIT
BREAKER

LCD-
DISPLAY

PORTA-
BLE

INCL.
MOUNTING
BRACKET

ROBUST
METAL-
HOUSING



LiFePO4 battery with BMS	80 Ah (12.8 V), 1024 Wh
Integrated sine wave inverter	1000 W (max. 2000 W short-term)
Integrated MPPT solar charge controller	max. 120 W / 50 V / 15 A
Connection options	<ul style="list-style-type: none"> ① 1x 230 V socket outlet ② 2x 12V cigarette lighter connection ③ 2x USB connection (5 V/3.1 A) ④ 4x Anderson connection (50 A) ⑤ 1x Anderson connection (175 A)
Rechargeable via	<ul style="list-style-type: none"> - 230 V mains supply via charger - Solar module (solar module voltage max. 120 W / 50 V / 15 A)
Dims. LxWxH / Weight	455x250x330 mm / app. 15 kg
Item no. Price	814136 1199,-

LiFePO4 battery with BMS	120 Ah (12.8 V), 1536 Wh
Integrated sine wave inverter	2500 W (max. 5000 W short-term)
Integrated MPPT solar charge controller	max. 400 W / 25 V / 30 A
Connection options	<ul style="list-style-type: none"> ① 2x 230 V socket outlet ② 2x 12 V cigarette lighter connection ③ 2x USB connection (5 V/3.1 A) ④ 4x Anderson connection (50 A) ⑤ 1x Anderson connection (175 A)
Rechargeable via	<ul style="list-style-type: none"> - 230 V mains supply via charger - Solar module (solar module voltage max. 400 W / 25 V / 30 A) - Integrated charging booster
Dims. LxWxH / Weight	420x250x330 mm / app. 25 kg
Item no. Price	814137 2199,-



Scope of delivery:

① LithPowerUnit 80, ② Mains charger (input: 200-240 V / output: 14.6 V, 20 A), ③ Jumper cable (2 m, cable Ø 16 mm²) with 1 x 175 A Anderson plug & battery crocodile clips, ④ Solar cable (1.5 m, cable Ø 6 mm²) with 2 x 50 A Anderson plugs, ⑤ Universal cable (1.5 m, cable Ø 6 mm²) with 1 x 50 A Anderson plug & 1x open cable end, ⑥ 50 A Anderson plug incl. 2x crimp contacts (for cable Ø 6 mm²), ⑦ Various cover caps for the Anderson connections, ⑧ Fastening material (incl. 2 x lashing eyes & 1 x tensioning strap).

Scope of delivery:

① LithPowerUnit 120, ② Mains charger (input: 200-240 V / output: 14.6 V, 20 A), ③ Jumper cable (2 m, cable Ø 16 mm²) with 1 x 175 A Anderson plug & battery crocodile clips, ④ Solar cable (1.5 m, cable Ø 6 mm²) with 1 x 50 A Anderson plug & 1 x open cable end, ⑤ Connection cable for the D+ signal (ING cable, app. 6 m), ⑥ 4 x 50 A Anderson plugs incl. crimp contacts (for cable Ø 6 mm²), ⑦ Various cover caps for the Anderson connections, ⑧ Fastening material (incl. 2 x mounting brackets, 2 x lashing eyes & 1 x tension strap).



DOWNLOAD THE CARBEST APP FOR FREE NOW!

On all CARBEST LiFePO4 batteries with Bluetooth function, you can check the battery status, charge status and more at any time via smartphone or tablet using the CARBEST app.



For smartphones and tablets with iOS or Android

LiFePO4 BATTERIES WITH BLUETOOTH TECHNOLOGY



50 Ah **BLUE TOOTH**

HEAT-FUNCTION **M8 THREAD**

Li50BT-H: Fits perfectly in compartment of rear right side wall of Volkswagen Multivan from YOC. 2022 onwards

12V **BLUE TOOTH** **BMS** **VERY LONG-LASTING** **INSTALLATION LYING POSSIBLE** **FREE CARBEST APP**



- Battery status readable via mobile/tablet
- Series connection possible: up to 4 batteries
- Parallel connection possible: up to 2 batteries
- Battery protection through integrated battery management
- Cycle life ≥ 3000 at 90% DOD or max. 7 years warranty*
- Only approx. 1/3 of the weight of a conventional lead-acid battery
- Lithium batteries marked BT-H with integrated heating function for effective charging even at sub-zero temperatures
- Integrated display with charge level indicator



100 Ah **BLUE TOOTH**

HEAT-FUNCTION **M8 THREAD**

How heating function works: internal BMS continuously monitors ambient temperature of battery & controls integrated heating function fully automatically. If a temperature $\leq 0^{\circ}\text{C}$ is measured during the charging process, BMS immediately stops battery charging & simultaneously activates the heating function of the battery. After reaching $+5^{\circ}\text{C}$, the charging process continues automatically. If the temperature rises above 10°C , the heating function is deactivated again.

Battery	Volt (V)	Ah	Max. Discharge current short term	Dims. LxWxH mm	Weight kg	itemNo.	Price
Li50BT-H	12	50	100 A (<5sec.)	195x132x183	app. 7.5	814100	499,-
Li100BT-H	12	100	150 A (<5sec.)	330x170x195	app. 14	814131	999,-
Li100BT	12	100	150 A (<5sec.)	330x170x195	app. 14	81413	764,15

Li50BT-H expected to be available Q2/2024.



100 Ah **BLUE TOOTH**

M8 THREAD



Integrated LED display on top of the battery with charge level indicator.

LiFePO4 BATTERIES

12V
100 to 200 Ah
BMS
COMPACT DESIGN
VERY LONG-LASTING
INSTALLATION LYING POSSIBLE



- Reliable and powerful battery technology, for tough continuous use!
- Battery protection through integrated battery management
- Low self-discharge when not in use, as a sleep mode is automatically activated after 24 h without charging/discharging
- Ideal replacement for heavy AGM batteries
- 3 times less weight - thus more payload possible
- Cycle life ≥ 3000 at 90% DOD or max. 7 years warranty*
- Horizontal installation possible

100 Ah
2 CARRYING HANDLES

- Strong price-performance ratio
- Series connection possible: up to 4 batteries
- Parallel connection possible: up to 2 batteries
- Housing with 2 integrated carrying handles

Battery	Volt (V)	Ah	Max. Discharge electricity	Max. Discharge current short term	Weight kg	Item no.	Price
Li100	12	100	100 A	200 A (< 5s.)	12,5	81451	764,15

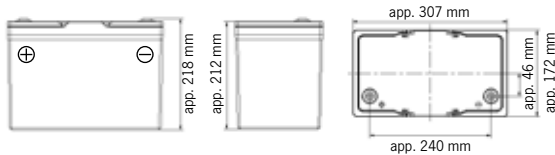

100 Ah
M8 THREAD

764,15



100 Ah
BLUE TOOTH
HEAT-FUNCTION
DIN H6 HOUSING
1 CARRIER HANDLE
FREE CARBEST APP

- DIN H6 housing, specially designed for mounting under driver's seat of Volkswagen Transporter 6.1 / 6 / 5
- Standard car battery terminals
- Series connection possible: up to 4 batteries
- Parallel connection possible: up to 2 batteries

Battery	Volt (V)	Ah	Max. Discharge electricity	Max. Discharge current short term	Weight kg	Item no.	Price
Li100BH6	12	100	100 A	350 A (< 3s.)	12,5	81452	999,-



100 Ah
STANDARD BATTERY-POLE

Battery, charge status and more can be checked at any time via smartphone or tablet using the CARBEST app.

Under-seat battery: Specially designed for mounting under seat in Volkswagen Transporter 6.1 / 6 / 5



LiFePO4 UNDER-SEAT BATTERY

200 Ah
BLUE TOOTH
HEAT-FUNCTION
METAL-HOUSING
FREE CARBEST APP

- Metal housing with special dimensions, suitable for under-seat mounting Fiat Ducato and similar vehicles
- M8 screw thread on the front of the battery
- Series connection possible with up to 4 batteries
- Parallel connection possible with up to 4 batteries

Battery	Volt (V)	Ah	Max. Discharge electricity	Max. Discharge current short term	Weight kg	Item no.	Price
Li200BHD	12	200	150A	350 A (< 3s.)	25	81453	1890,-

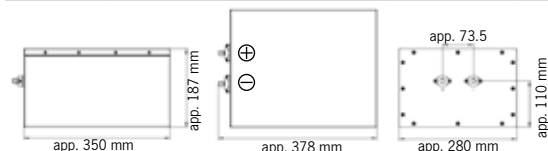

200 Ah
M8 CONNECTION

Battery, charge status and more can be checked at any time via mobile or tablet using Carbest app.

Under-seat battery: Specially designed for mounting under the seat in Fiat Ducato and similar vehicles



* Please note our warranty conditions on page 114.

LONG LIFE DEEP-CYCLE AGM BATTERIES

12V
LONG LIFE DEEP-CYCLE
MAINTENANCE FREE
COMPACT DESIGN

- Maintenance-free service battery for campervans and motorhomes
- High vibration resistance and leak proof
- Position-independent installation possible
- High cycle stability, also ideal for use in combination with a solar system
- Low self discharge

CARBEST AGM batteries have been specially developed for use in motorhomes. Thanks to AGM technology (Absorbent Glass Mat), the batteries are completely maintenance-free. The batteries can be installed vertically or horizontally (not upside down, with the battery terminals facing downwards). The T100 battery can be installed under the front seat in Volkswagen T5/T6 and Fiat Ducato.

The high vibration resistance, very good cycle stability and low self-discharge make the batteries the perfect energy storage for campervans and motorhomes. Thanks to their compact dimensions, they fit into common battery compartments or storage compartments. AGM batteries are frost-proof up to a temperature of -40°C.



Battery	Volt (V)	Ah	Dimensions LxWxH (mm)	Battery terminal Thread	Weight (kg)	Item no.	Price
① AGM 60*	12	60	258x167x213 °	M6	23,5	850534	224,-
② AGM 80*	12	80	350x167x179 °	M6	22,5	850529	234,-
③ AGM 90*	12	90	306x168x216 °	M6	29	850535	295,-
④ AGM 100*	12	100	330x171x220 °	M8	29,0	850531	239,-
⑤ AGM T100	12	100	353x175x190	---	26,3	850530	259,-
⑥ AGM 120*	12	120	330x173x218 °	M8	33,5	850536	339,-
⑦ AGM 134*	12	134	340x174x285 °	M8	42,5	850537	389,-

° plus height of battery terminal screws

*Included in the scope of delivery:

Battery pole adapter set

For conversion from M6 or M8 female pole threads to a standard SAE conical pole (+/-). Scope of delivery: Set of terminals (+/- pole) including screws. Not included with AGM T100 battery (850530).



Which battery to use? Normal starter batteries are not designed for cyclic stress and are not recommended as on-board batteries. Cycle-resistant batteries are suitable for the stress that occur during discharge/charge operation. A distinction is made between batteries with bound electrolyte in gel or AGM design, classic liquid/acid batteries and LiFePO4.

Gel, AGM and LiFePO4 batteries are leak-proof and absolutely maintenance-free over the complete service life. All battery types achieve high cycle stability under the required charging conditions.

Gel batteries can also be discharged very deeply for a short time, always provided that they are immediately recharged.

AGM batteries have a slightly higher performance for same box size & can also cope with very high charge/discharge currents in short term.

Batteries in LiFePO4 version (see previous pages) are lightest energy storage devices with highest energy density. The price is far higher, but this is somewhat offset by the longer service life that can be expected with the existing infrastructure.

The service life of a battery is measured in charge cycles. 1 charge cycle means: 1 x discharge, 1 x charge. In this case, the smaller the amount of energy extracted (in percentage terms), the longer the service life. At a maximum discharge of 30% app. 1200 charging cycles. If it is always discharged by 50%, the life is reduced to about 500 cycles. With classic starter batteries (lead / acid), this difference is much greater. (After installation or before winter storage min. 24 h charging.)

Notes on battery disposal:

You are required by law to return old batteries and accumulators. You can do this free of charge in a retail store or at another collection point near you. Addresses of suitable collection points can be obtained from your city or local government. Symbol of crossed-out trash can on batteries or accumulators indicates that they must not be disposed of with household waste. Respective chemical symbol (Hg, Cd or Pb) below the symbol of the crossed-out dustbin indicates that batteries or accumulators contain mercury, cadmium or lead. Further information can also be found on the Internet at <https://www.batteriegesezt.de/>

BATTERY POLE ACCESSORIES

Battery terminal adapter set

For converting batteries with M6 or M8 internal terminal thread to standard SAE cone terminal (+/-). Scope of delivery: Set of terminals (+/- pole) incl. screws.

- ① M6 thread 812761 4,50
- ② M8 thread 812762 4,50

Battery terminal cover set

- ③ Terminal cover for car batteries. Material plastic. Black/Red 81276 0,80
- ④ Terminal cover for lithium batteries with M8 threaded screws 812760 0,80



ENERGY STATION

Turns a standard battery into a multifunctional power station

- Digital voltmeter for battery monitoring
- 2x USB (2,4 A), 2x 12V socket, 2x Anderson 50 A connector
- For batteries up to size LxWxH 330x180x220 mm

① **The Energy Station** is made of robust plastic and offers a wide range of connection options. Integrated in the cover are: External terminals (+/-), 1x USB double socket (2x 2.4A), 2x 12V sockets, 1x battery voltmeter, 2x Anderson 50 A for connecting solar panels and other accessories. Fuses are pre-installed. Suitable CARBEST LiFePO4 batteries: 814100, 81413, 814131, 81451, 81452. Suitable CARBEST Long Life Deep-Cycle AGM batteries: 850534, 850535, 850531, 850536. Scope of delivery incl. tensioning strap to fix the lid and tensioning strap eyelets. Supplied without battery. 813740 79,90

② Universal adapter cable, length 3 m

For connection to Energy Station for charging the battery or for connecting various consumers. Cable length 3m, cable cross section red/black 10mm², 1x open cable ends, 1x Anderson 50 A. 850922 29,95



THE COMPACT INTELLIGENT CHARGER WITH 4 A



- LCD display
- Diagnostic & revival function
- For 6/12V batteries (AGM, gel, wet)
- 5 stage charging program
- Controlled conservation charge

Microprocessor-controlled charger with 4 A charging capacity. Technical data: Protection class IP65, battery capacity: max. 120 Ah. Input voltage: 220-240 V AC/ 50 Hz, max. 70 W. Output voltage: max. 14.7 V DC/4.0 A. Dimensions: LxWxH 18 x 8 x 5 cm. Weight: 0.5 kg. **819010 30,56**

CHARGING DEVICES WITH 10 A OR 20 A



- 12V
- 10 A / 20 A
- 3 STEPS CHARGE
- BATTERY TYPE SELECTABLE
- ALSO FOR LiFePO4 BATTERIES

For charging GEL / AGM / lead-acid / LiFePO4 batteries. Battery type selectable via rotary switch. 3 stage charging program with short circuit, overcharging, reverse polarity and overheating protection.

Input voltage: 180-240 V AC, Output voltage: Max. 14.6 V DC. Incl. Connection cable and battery terminals.

Charger 10 A, weight approx. 0.9 kg. Dimensions: LxWxH 150 x 130 x 50 mm **80280 89,90**

Charger 20 A, Weight approx. 1.3 kg. Dimensions: LxWxH 160 x 150 x 70 mm **80281 129,90**

INTELLIGENT PROFESSIONAL CHARGERS WITH THE LATEST 7 STAGE CHARGING TECHNOLOGY



- 12V
- 10-40 A
- 7 STEPS CHARGE
- BATTERY TYPE SELECTABLE
- ALSO FOR LiFePO4 BATTERIES
- ECE R10

- For charging gel / AGM / lead-acid / LiFePO4 batteries
- 2 charging outputs 12V
- The automatic 7 stage charging algorithm delivers a much faster, more efficient and more complete charge without voltage drops occurring
- This intelligent battery charger can be used as a constant power supply for accessories that need a stable and clean DC voltage
- Device cooling via integrated fan

Product	Battery capacity	Connection cable	Dimensions (mm)	kg app.	Item no.	Price
① 10 A	15-100 Ah	4 mm ²	176x175x95	1,3	80286	129,-
② 15 A	20-150 Ah	4 mm ²	176x175x95	1,3	80287	189,-
③ 20 A	25-200 Ah	4 mm ²	176x175x95	1,3	80288	219,-
④ 40 A	50-400 Ah	10 mm ²	276x175x95	3,0	80289	329,-

BATTERY CHARGER BOOSTER 12V / 30 A

12V 30 A LEAD ACID AGM GEL LiFePO4 EURO 5/6 BLUE TOOTH READY ECE R10



- Very compact design
- Optimizes battery charging & compensates for power losses
- Suitable for lead-acid / AGM / GEL / LiFePO4 batteries
- Ideal for vehicles with intelligent alternator (Euro 5/6)
- Bluetooth-capable with Bluetooth module 851007

Optimum charging of on-board battery while driving. High charging capacity without loss of power is guaranteed even for shorter journeys.

Technical data:

Input voltage: 12 V, charging capacity: 30 A, battery capacity: 45 - 280 Ah, weight: 0.46 kg. **821822 159,90**



Optional accessories:

- ① Bluetooth module with 3m cable (free app for Android and iOS) **851007 29,90**
- ② Temperature sensor with 3m cable **851004 10,30**



BATTERY CHARGE BOOSTER 25 A 40 A WITH INTEGRATED 18 A REFRIGERATOR OUTPUT

12V 25 A / 40 A 18 A REFRIGERATOR OUTPUT LEAD ACID AGM GEL LITHIUM IUoU CHARGING CHARACTERISTICS EURO 5/6 ECE R10

- Charging characteristic: IUoU
- For vehicles with intelligent alternator (Euro 6 suitable)
- Operation with / without D+ signal
- Built-in fuses (B1, B2 and refrigerator)
- Uncomplicated plug & play installation



The battery charging boosters from CARBEST with 25A or 40A power charge your on-board or secondary battery quickly and reliably while driving.

The IUoU charging characteristic supplies battery with constant current & voltage matched to it. After reaching charging end voltage, the changeover to float charge takes place.

This compensates for the self-discharge of the battery.

Via the special, integrated 18A refrigerator output, an absorber or compressor refrigerator can be supplied directly from the charge booster with power.

When the engine is running and/or the starter battery B1 is relatively charged, the output of the refrigerator is fed directly from B1. When the engine is at standstill and/or the starter battery B1 is relatively low charged, the output of the refrigerator is switched off or fed by B2, depending on the setting of DIP switch No. 3.

Operating temperature range: +10°C to +50°C. Integrated undervoltage and overvoltage protection as well as reverse polarity protection.

Dims.: L x W x H 200 x 142 x 72.5 mm, Weight: 1.1 kg

DC-DC Booster 25 A 821820 205,-
DC-DC Booster 40 A 821821 299,-

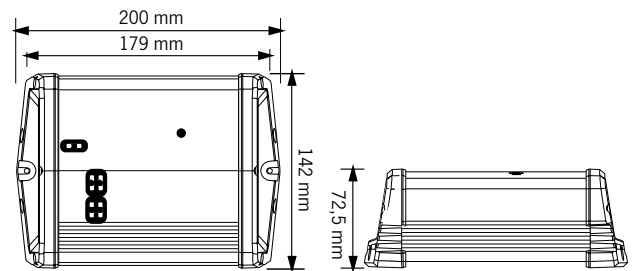

Connection diagram

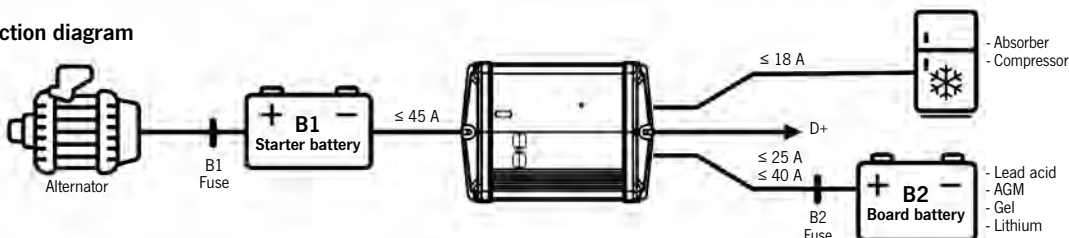

SINUS POWER INVERTER WITH PURE SINUSOIDAL VOLTAGE FOR SENSITIVE 230V DEVICES



12V
INPUT

230V
OUTPUT

USB
2.1A

INCL.
CONNECTION
CABLE

REMOTE
CONTROL
OPTIONALLY

ECE R10



From 1000 watts:
Tested with a
2200 W air
conditioner
(1500W + 2000W + 3000W)
Watch video here



From 2000 watts:



Tested with
Nespresso®
capsule machine
(2000W)
Watch video here

Connection cable
in suitable strength
included in delivery:
contain
(2x 2m + 1x 0,4m)

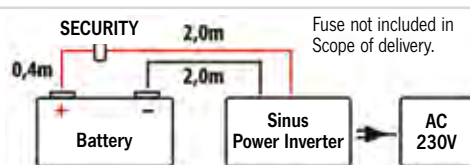

Matching cable remote controls

For ① with 4.5 m cable

81949 24,90

For ② ③ ④ ⑤ ⑥ with 5 m cable

81947 24,90



- Extremely high starting current, up to 3 times the power
- convert 12 V battery current to 230 V
- Switch-mode technology: Almost noiseless - light & compact
- Battery protection due to undervoltage cut-off
- Overtemperature shutdown (approx. 60° C)
- Reverse polarity protected
- Integrated overload protection
- Including connection cable, cable remote control optionally available

Automatic load detection - The inverter switches to a power saving mode if no power is drawn for one minute. Fan - If the temperature is too high, the built-in temperature-controlled fan switches on automatically for cooling. Aluminum housing - Suitable for floor & wall mounting.

NOTE: Fuse required

To install the inverters of this page we recommend using a 12V fuse.
300W=50A / 700W+1000W=100A / 1500W=150A / 2000W=200A / 3000W=300A.

Figure	①	②	③	④	⑤	⑥
Type	PS300U	PS700U	PS1000U	PS1500U	PS2000U	PS3000U
Input voltage DC	12 V	12 V	12 V	12 V	12 V	12 V
Output voltage (±5%)	230 V	230 V	230 V	230 V	230 V	230 V
Continuous output	300 W	700 W	1.000 W	1.500 W	2.000 W	3.000 W
Nominal output	300 W	700 W	1.000 W	1.500 W	2.000 W	3.000 W
Short term peak output	600 W	2.100 W	3.000 W	4.500 W	6.000 W	9.000 W
Switch-off threshold/ Undervoltage	10,0±0,5 V	10,0±0,5 V	10,0±0,5 V	10,0±0,5 V	10,0±0,5 V	10,0±0,5 V
Quiescent current	≤0,6 A	≤0,3 A	≤0,4 A	≤0,5 A	≤0,6 A	≤0,8 A
Efficiency	≥90%	≥90%	≥90%	≥90%	≥90%	≥90%
Connection remote control	yes	yes	yes	yes	yes	yes
USB port/ampere	yes/2.1A	yes/2.1 A	yes/2.1 A	yes/2.1 A	yes/2.1 A	yes/2.1 A
Sockets	1	1	1	2 (1x Schuko, 1x Universal)*		
3 connection cables included	2x 2m & 1x 0,4m (4mm ²)	2x 2m & 1x 0,4m (16mm ²)	2x 2m & 1x 0,4m (25mm ²)	2x 2m & 1x 0,4m (50mm ²)	2x 2m & 1x 0,4m (50mm ²)	2x 2m & 1x 0,4m (50mm ²)
Dimensions (LxWxH) mm	260x150x60	255x186x90	317x186x90	320x152x105	320x152x105	475x250x110
Weight	1,6 kg	2,4 kg	3,0 kg	4,7 kg	4,8 kg	6,5 kg
Item no.	82281	82285	82282	82286	82283	82284
Price	129,-	219,-	319,-	449,-	679,-	849,-

SINE WAVE POWER INVERTER WITH PURE SINE WAVE VOLTAGE AND INTEGRATED MAINS PRIORITY CIRCUIT

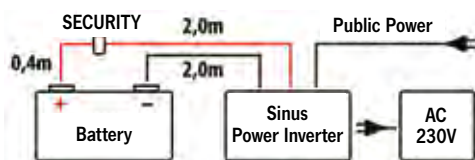
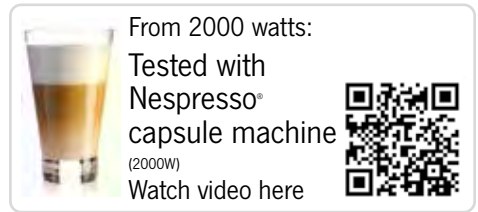
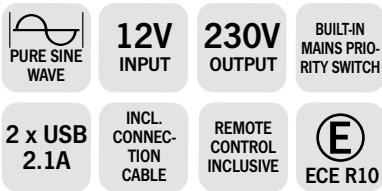

NOTE: Fuse required
 We recommend a 12V fuse for installing the inverters on this page.
 1000W=100A / 1500W=150A / 2000W=200A
 Fuse not included in the scope of delivery.

Figure	①	②	③
Type	Sine power inverter 1000 W	Sine power inverter 1500 W	Sine power inverter 2000 W
Input voltage DC	12 V	12 V	12 V
Output voltage (±5%)	230 V	230 V	230 V
Continuous output	1000 W / 80 A	1500 W	2000 W / 160 A
Nominal output	1000 W	1500 W	2000 W
Short term peak output	2000 W	3000 W	4000 W
Shutdown threshold/undervoltage	10,5±0,5 V	DC 10,5±0,5 V	DC 10,5±0,5 V
Quiescent current	≤0,45 A	≤0,75 A	≤0,75 A
Efficiency	>90%	>90%	>90%
Switch over time 230 V to 12 V (approx.)	≤ 8 ms	≤ 10 ms	≤ 10 ms
USB port/ampere	yes/2.1A	yes/2.1A	yes/2.1A
Sockets	1x Schuko, 1x Universal*	1x Schuko, 1x Universal*	1x Schuko, 1x Universal*
3 connection cables included	2x 2m & 1x 0,4m (25mm²)	2x 2m & 1x 0,4m (50mm²)	2x 2m & 1x 0,4m (50mm²)
Battery charger (gel/AGM)	10 A	15 A	15 A
Dimensions LxWxH in mm (approx.)	330 x 230 x 110 mm	400 x 230 x 110 mm	400 x 230 x 110 mm
Weight	approx. 3.6 kg	approx. 5.3 kg	approx. 5.7 kg
Item no.	82277	82278	82279
Price	379,-	589,-	619,-

- **Integrated 230 volt mains priority circuit:** As soon as 230 volt shore power (e.g. from the camping site) is available, the inverter operation is automatically interrupted. Inverter operation is immediately resumed when no more external power is available.
- **Transformation from 12 V to 230 V sine wave voltage**
- **Very high starting current possible**
- **3 stage battery charger for gel & AGM batteries**
- **Battery protection due to undervoltage cut-off**
- **Reverse polarity protected**
- **Integrated overload protection**
- **Temperature controlled fan**
- **Aluminum housing, lightweight but strong**
- **Connection cable and cable remote control included**

Spare/extension cable		
Pre-assembled with 2 ring eyelets.		
± 25 mm², 2 x 200 cm	81940	46,90
± 50 mm², 2 x 200 cm	81941	76,90
Cable remote control (as spare part)		
	81946	24,90

*Not approved for simultaneous operation!

SINUSOIDAL INVERTER: 230 VOLT DEVICES OPERATE WITH 12 VOLT

SINUS SIMILAR	12V INPUT	230V OUTPUT	USB 2.1A
200 W BIS 1000 W	INCL. CONNEC- TION CABLE	E ECE R10	

- Use of many common household appliances
- USB port 5 V ~ 2.1 A
- Battery protection through undervoltage and overvoltage shutdown
- Reverse polarity protected
- Integrated overload protection
- Overtemperature shutdown (> 75° C)



Figure	①	②	③	④
Type	Power inverter 200 W	Power inverter 400 W	Power inverter 600 W	Power inverter 1000 W
Input voltage DC	12 V	12 V	12 V	12 V
Input voltage range	10,5 V-16 V	10,5 V-16 V	10,5 V-16 V	10,5 V-16 V
Nominal output	200 W	400 W	600 W	1000 W
Peak power short term (2S)	400 W	800 W	1200 W	2000 W
Output voltage (±5%)	220 - 240 V	220 - 240 V	220 - 240 V	220 - 240 V
Shutdown threshold/undervoltage	10,0±0,5 V	10,0±0,5 V	10,0±0,5 V	10,0±0,5 V
Quiescent current	<0,17 A	<0,21 A	<0,3 A	<0,33 A
Efficiency	>90%	>90%	>90%	>90%
Cooling	Fan	Fan	Fan	Fan
Protection	yes	yes	yes	yes
Connection for remote control	no	no	no	no
USB port/ampere	yes/2.1A	yes/2.1A	yes/2.1A	yes/2.1A
Socket	1	1	1	1
Dimensions (W x D x H) in mm	120 x 100 x 50	120 x 100 x 50	150 x 100 x 50	210 x 150 x 70
Weight	approx. 0.6 kg	approx. 0.7 kg	approx. 1 kg	approx. 2 kg
Item no.	82291	82292	82293	82294
Price	39,90	49,90	64,90	99,90

12/24 V MODULES FOR FREE COMBINATION

12V
24V

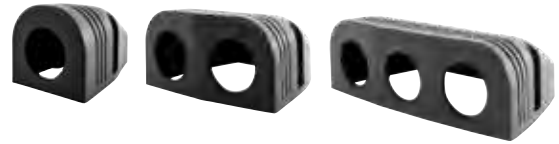

Mounting frames

Front panels to mount sockets or indicators. Individually configurable with all CARBEST power sockets / USB sockets / voltmeters, hole diameter: Ø 29 mm. Dims. (L x W x H) mm

1-way	60 x 42,5 x 5,5 mm	811221	1,50
2-fold	105 x 42,5 x 5,5 mm	811222	1,90
3-way	150 x 42,5 x 5,5 mm	811213	2,30
4-way	195 x 42,5 x 5,5 mm	811226	2,90
4-way (square)	100 x 110 x 8 mm	811227	3,20

Surface-mounted housing

Surface-mounted housing for mounting sockets or indicators. Individually configurable with all CARBEST power sockets / USB sockets / voltmeters. Hole diameter: Ø 29 mm

1-fold:	dimensions (L x W x H): 80 x 55 x 50 mm	811223	2,60
2-fold:	Dimensions (L x W x H): 80 x 100 x 50 mm	811224	4,50
3-fold:	Dimensions (L x W x H): 80 x 150 x 50 mm	811225	5,90



Rocker switch (ON/OFF) with control lighting

With red LED indicator light, rocker switch for switching on/off with red indicator light. Load capacity: 12V - 10A / 24V - 6A. Hole: Ø 29 mm

811217 2,90



Temperature display with probe

3-digit digital display (illuminated red), Tempmeter incl. temperature sensor. Reliable indication of the ambient temperature. Temperature range: -40 - 125°C, Hole: Ø 29 mm

811220 13,90



LED voltmeter

3-digit digital display (illuminated red), voltmeter (6 - 28V) for digital display of the voltage applied in volts. Hole: Ø 29 mm

811218 14,60



Dual LED voltmeter for vehicle and on-board battery

3-digit digital display (illuminated in red), dual LED voltmeter (10 - 60V) for displaying the voltage, ideal for monitoring the vehicle battery and additional battery. Hole: Ø 29 mm

811219 19,90



Power socket

For operating 12V or 24V devices, universal socket incl. protective cap. Also suitable as a charging input. Load capacity: 12V-20A / 24V-10A. Hole: Ø 29 mm

811210 4,20



Dual USB charging socket

1x USB-A / 1x USB-C

USB built-in socket (illuminated blue) incl. protective cap. Input: 12V / 24V, Output USB-A: QC 3.0 (3.6V - 12V, max. 32W), Output USB-C: QC 4.0 (5V - 20V, max. 60W), Hole: Ø 29 mm

811211 19,90



LED voltmeter with integrated USB charging socket

LED voltage indicator (illuminated blue) incl. USB charging option, LED voltmeter with integrated USB charging socket. The display can be switched on or off via an ON/OFF touch switch. Including protective rubber cap with cut-out for reading the voltage, input: 12V / 24V, output USB-A: QC 3.0 (3.6V - 12V, max. 18W), hole: Ø 29 mm

811212 18,50

12/24 V POWER DISTRIBUTION

Power distributor with fuse holder and LED failure indicator

- LED failure indicator
- Integrated negative rail
- Transparent plastics cover
- Includes pictogram sticker for labeling

Compact fuse and distribution box for 6 or 12 circuits. A red LED light immediately signals when a fuse has blown. Load capacity per circuit: max. 30A. Total load capacity: max. 100 A. Voltage: max. 32 V. (Supplied without fuses)

- ① **6 Circuits**, Dimensions: LxWxH 87.8 x 88 x 36.5 mm
810220 24,95
- ② **12 Circuits**, Dimensions: LxWxH: 165 x 85 x 39 mm,
810221 39,95



Extra strong fuse module for FKS fuses

Switch and distribution box SVB 13 12 V cut-off relay 30 A, battery monitor D+ simulator, 2 outputs, load fused with 20 A, connection for charger. If the battery voltage of the 2nd battery is >13.7 V, the first battery is also charged.

Dims.: LxWxH 130x130x50 mm. **80090 117,02**

12 V CHARGING SOCKET / USB CHARGING PLUG



Aluminum housing

USB charging plug

- With cigarette lighter plug
- High quality aluminum housing
- USB-A and USB-C output

USB 3.0 and USB-C input for fast charging of up to two devices. Blue status LED indicates operational readiness. **Technical data:** Input: DC 12/24V. Output USB-A/QC 3.0: 5V/3A, 9V/2A, 12V/1.5A (max. 18 W). Output USB-C/PD: 5V/3A, 9V/2A, 12V/1.5A (max. 18 W) Dimensions: L 64.5 x Ø 26.5 mm. Weight: 25g

813032 7,50



12V

Mounting plate with 12 V Socket and 50 A plug connector

Very flat installation panel with 12V/24V power socket and recessed 50A power connector. Incl. 6 receptacles for the following cable cross-sections: 2x 4- mm², 2x 5-10 mm², 2x 8-16 mm², Dimensions (L x W x H): 75 x 60 x 6 mm

811214 18,99



12V

Multiple distributor

Each with 2 USB ports. 5 V, Max. 5 A, 2.1 A. 20 cm spiral cable, extendable up to approx. 1 m. With fuse and red LED power indicator.

2-fold distributor 81323 5,87
3-way distributor 81317 6,50



12V
24V

Universal distributor

To be placed in the cupholder. 2 x USB port, 5 V, 500 mA, 2 x universal socket. 20 cm spiral cable, max. 5 A, with fuse. 4-way LED operation indicator

81315 3,33



12V
24V

Twin clutch, can be angled

12/24 V, for cigarette lighter socket, can be angled in 2 directions up to 90°. max. 10 A, with fuse and LED power indicator. 81321 1,53



12V
24V

Cigarette lighter socket with battery terminals

12 / 24 V, 10A, cable length 1.0 m, cable cross-section: 2x 0.75mm². With cover cap. Weight: 0.1 kg. 81322 3,60



12V
24V

Twin clutch

12/24 V, for cigarette lighter socket. 2 gr. Couplings and cover caps, cable length 2 x 1.4 m, max. 5 A, with fuse and operation indicator.

81320 2,32

CELL PHONE / TABLET HOLDER



Universal tablet / cell phone holder

For device widths of approx. 10 - 17.7 cm, 360° rotatable, for headrest, bicycle, etc.

462381 20,92



Tested in the 10.000 km endurance test

Universal satnav and cell phone holder

With suction cup attachment, rotatable through 360°, Retaining clips open up to 105 mm. Material: ABS+PU, black. Dimensions: 12x10x7,5cm. (Delivery without smartphone).

46238 7,95

CABCOOLER 8 + 14 COMPRESSOR COOLERS FOR THE CAB



Storage compartment with inductive charging station



Capacity for bottles with a height of max. 260 mm



Click-On included Mounting plate



Fits perfectly between the cab seats in the Volkswagen Transporter 6.1 / 6 / 5

CabCooler 8

Fits perfectly between the driver and passenger seat in the Volkswagen Transporter 6.1 / 6 / 5

VW T6/T5	12V / 24V	8 LITER	INDUCTIVE CHARGING STATION	3x USB PORT	LED DISPLAY	INCL. ASSEMBLY-PLATE	INCL. 12/24 V CABLE
Total useful capacity (liters)		8 L					
Ø Current consumption		12V: 4.0A / 24V: 2.0A					
Ø Power consumption		45 W					
Temperature range		+20 °C to -15 °C					
Operating volume		< 45 dB					
Dimensions (LxWxH)mm / Weight		538x190x390 / app. 8.6 kg					
Item no. / Price		713543		349,-			

100-240 V adapter cable

Allows operation with 230 V voltage.

714499 24,90

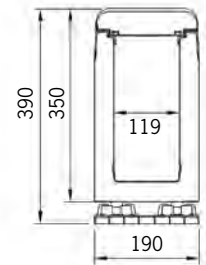
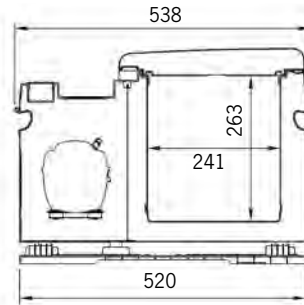

Integrated cup holder



Capacity for bottles with a height of max. 320 mm



Click-On included Mounting plate



Fits perfectly between the cab seats in Fiat Ducato

CabCooler 14

Fits perfectly between the cab seats in Fiat Ducato

FIAT DUCATO	12V / 24V	BATTERY OPERATION POSSIBLE	14 LITER	2 CUP-HOLDER	3x USB PORT
LED DISPLAY	INCL. ASSEMBLY-PLATE	INCL. 12/24 V CABLE			

Total useful capacity (liters)		14 L			
Ø Current consumption		12V: 4.0A / 24V: 2.0A			
Ø Power consumption		45 W			
Temperature range		+20 °C to -15 °C			
Operating volume		< 45 dB			
Dimensions (LxWxH)mm / Weight		591x230x453/app. 9.3 kg			
Item no. / Price		713544		379,-	

Rechargeable 15.6 Ah battery with LED battery status indicator

Running time up to 20 hours (depending on setting and cooler version)

714690 149,-

100-240 V adapter cable

Allows operation with 230 V voltage.

714499 24,90

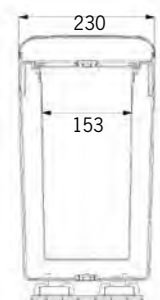
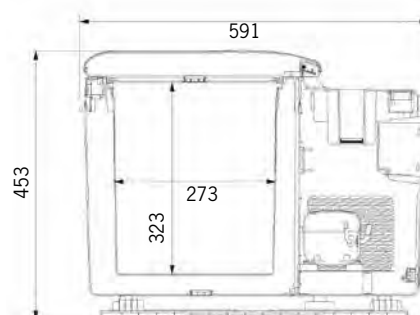

15.6 Ah battery optionally available. Allows food to be cooled even with the ignition off or parked vehicle.

Battery not included

FREECOOLER 8 + 13

MOBILE COMPRESSOR COOLERS - COOLING WITH 12/24 V OR LITHIUM BATTERY

- 12V / 24V**
- BATTERY OPERATION POSSIBLE
- LED DISPLAY
- ECO/MAX MODE
- INCL. BATTERY-PROTECTION
- USB PORT
- INCL. 12/24 V CABLE
- INCL. COOL-BATTERY
- ROBUST HOUSING

- Portable compressor coolers
- Operation via 12/24V or via optional rechargeable battery
- Perfect when no power connection is available
- Handling via LED panel
- Includes removable cooling battery in the lid
- Integrated USB port
- Three-stage vehicle battery protection
- Robust plastic housing with sturdy handle
- Including 12/24V connection cable

Delivery of the coolers without battery & without 100-240 V adapter cable.

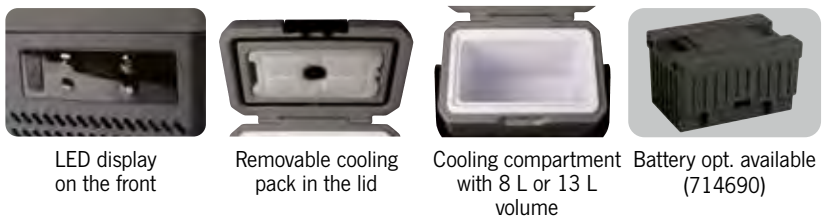

8L
VOLUME

1x
BATTERY
COMPART-
MENT



① FreeCooler 8

Total useful capacity (liters)	8 L
Ø Current consumption	12V: 4.0A / 24V: 2.0A
Ø Power consumption	45 W
Temperature range	+20 °C to -20 °C
Dims. (L x W x H) mm	393 x 251 x 443
Weight	app. 7.8 kg
Item no.	713551
Price	299,-

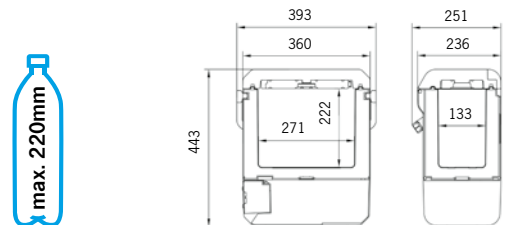

Optional accessories on page 39.



13L
VOLUME

2x
BATTERY
COMPART-
MENT



② FreeCooler 13

Total useful capacity (liters)	13 L
Ø Current consumption	12V: 4.0A / 24V: 2.0A
Ø Power consumption	45 W
Temperature range	+20 °C to -20 °C
Dims. (L x W x H) mm	433 x 306 x 467
Weight	app. 10.2 kg
Item no.	713552
Price	339,-

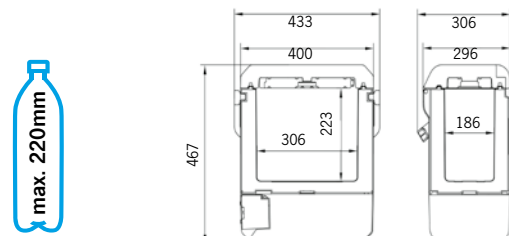

Optional accessories on page 29.

DUALCOOLER 45 + 72: COMPRESSOR COOLERS WITH 2-ZONE COOLING COMPARTMENT

- 12V
24V
- BATTERY OPERATION OPTIONAL
- DUAL ZONE
- LID COMPLETELY REMOVABLE
- LED TOUCH-DISPLAY
- ECO/MAX MODE
- INCL. BATTERY-PROTECTION
- USB PORT
- INCL. 12/24 V CABLE
- INTEGRATED BOTTLE OPENER
- ROBUST HOUSING

- **DUAL-ZONE:** The temperature of both cooling compartments can be regulated independently
- With 2 removable basket inserts
- Drain plug in the bottom of the main compartment
- 12/24V connection cable included

Delivery of the coolers without battery & without 100-240 V adapter cable.



① DualCooler 45

- Robust housing w/ integrated bottle opener
- Cutting board & drink holder in lid

Total useful capacity (liters)	45 L
2 interior comp. (liters)	1x 32 L, 1x 13 L
Ø Current consumption	12V: 5.0A / 24V: 2.5A
Ø Power consumption	60 W
Temperature range	+20 °C to -20 °C
Dims. (L x W x H) mm	600 x 400 x 506
Weight	app. 17 kg
Item no.	71469
Price	449,-

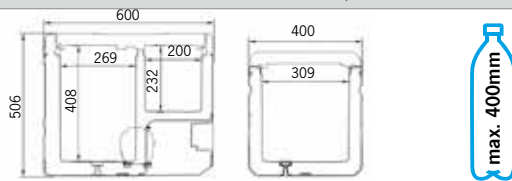

- ① DUAL ZONE
- 45L VOLUME
- 1x BATTERY COMPARTMENT



② DualCooler 72

- 2 separate cooling compartments with their own lid
- The telescopic handle and the large wheels allow comfortable transport of the cooler box

Total useful capacity (liters)	72 L
2 interior comp. (liters)	1x 27,5 L, 1x 44,5 L
Ø Current consumption	12V: 6.0A / 24V: 3.0A
Ø Power consumption	80 W
Temperature range	+20 °C to -20 °C
Dims. (L x W x H) mm	937 x 535 x 465
Weight	app. 25.7 kg
Item no.	71455
Price	699,-

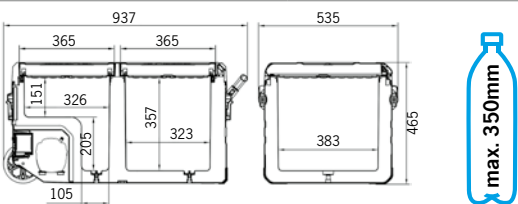

- ② DUAL ZONE
- 72L VOLUME
- 1x BATTERY COMPARTMENT

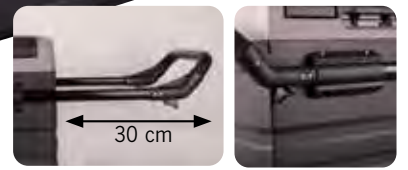

Transport handle extendable 30 cm Robust workmanship

- ① 100-240 V adapter cable, allows operation w/ 230V voltage. **714499 24,90**
- ② Lithium PowerPack - Rechargeable 15.6 Ah battery with LED battery status indicator Running time up to 20 hours (depending on outside temperature, cooler and cooler setting) **714690 149,-**
- ③ Solar connection cable 60 cm with 50 A high current connector to charge battery via a portable solar panel. Not for FreeCooler13 (713552). **714691 12,99**

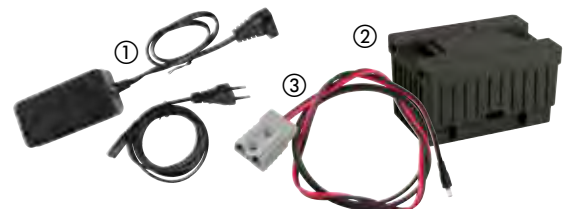

CAMP COOLER FOR EVERY USE



- 12V
24V**
- LED
DISPLAY**
- ECO/
MAX
MODE**
- INCL.
BATTERY-
PRO-
TECTION**
- INCL.
12/24V
CABLE**
- ROBUST
HOUSING**

- Ready for any use due to the robust design
- Easy cleaning thanks to removable basket insert
- Integrated cup holders in the lid
- 12/24 V connection cable included



Model	① 30 liters	② 40 liters	③ 50 liters
Useful capacity (L)	30 L	40 L	50 L
Ø Current consumption	12 V: 5.0 A / 24 V: 2.5 A		
Ø Power consumption	60 W		
Temperature range	+10 °C to -20 °C		
Operating volume	< 45 dB		
Dims. (LxWxH) mm	693x345x381	693x345x456	693x345x531
Weight (app.)	12,5 kg	13,0 kg	14,0 kg
Item no.	71456	71457	71458
Price	339,-	449,-	479,-

100-240 V adapter cable, allows operation w/ 230 V voltage.

714499 24,90

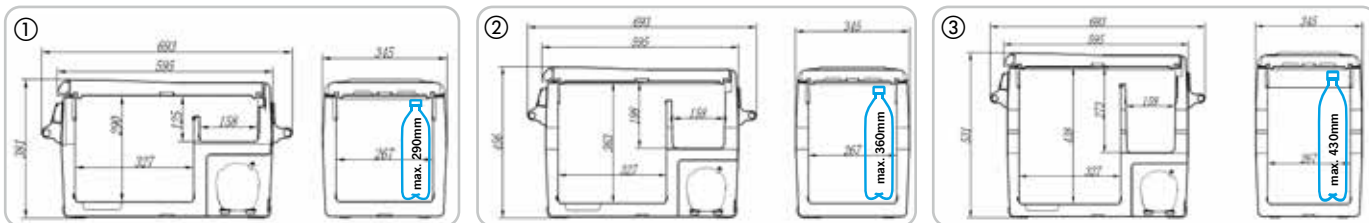

45L
VOLUME

POWER COOLER THE ALLROUNDER



- 12V
24V**
- LED
DISPLAY**
- INCL.
BATTERY-
PRO-
TECTION**
- INCL.
12/24V
CABLE**

- Easy cleaning thanks to removable basket insert
- Integrated lashing eyes for fastening a lashing strap
- 12/24 V connection cable included

Product	① PowerCooler 35	② PowerCooler 45
Useful capacity (liters)	Refrigerator/freezer 4.5 L/30.5 L	Refrigerator/freezer 7.0 L/38 L
Ø Current consumption	12 V: 4.6A / 24V: 2.3A	12 V: 5.4A / 24V: 2.7A
Ø Power consumption	55 W	65 W
Temperature range	+10 °C to -18 °C	
Operating volume	45 dB	
Dims. (L x W x H) mm	650 x 400 x 395	650 x 400 x 465
Weight (app.)	17,1 kg	18,5 kg
Item no. / Price	714102 499,-	714103 579,-

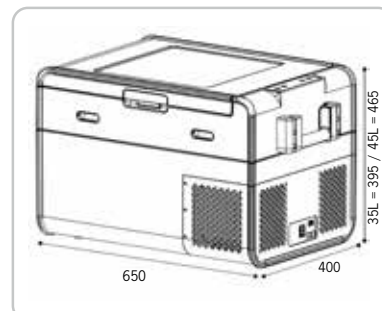

100-240 V adapter cable, allows operation w/ 230 V voltage.

714101 34,90

Delivery in each case without content

MAXIFREEZER: THE ROBUST ONES

LED
DISPLAY

LID
REMOVE-
ABLE

INCL.
12/24V
CABLE

INTERIOR
ILLUMI-
NATION

ROBUST
HOUSING

EDGE-
PRO-
TECTION

- 2 sturdy carrying handles (loadable up to 140 kg)
- Removable lid, can be opened on both sides
- Easy cleaning thanks to removable basket insert
- Electric thermostat with digital temperature display
- Battery monitor to protect the vehicle battery
- All boxes including 12/24 V and 220-240 V connection cable
- Thermal bag opt. available (except 71375)

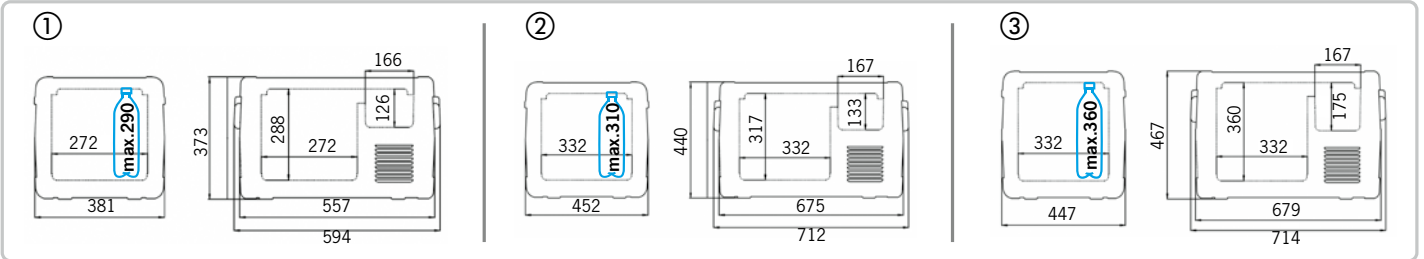

Model	① MaxiFreezer 28	② MaxiFreezer 40	③ MaxiFreezer 50
Useful capacity (liters)	Cooler/freezer 6/22	Refrigerator/freezer 7/33	Refrigerator/freezer 9/41
Ø Current consumption	DC 12 V/3.2 A DC 24 V/1.6 A	12 V/4.2 A 24 V/2.2 A 220-240 V/0.4 A	12 V/4.2 A 24 V/2.2 A 220-240 V/0.4 A
Supply voltage	12/24 Volt DC, 220-240 Volt AC		
Temperature range	+10 °C to -16 °C		+10 °C to -20 °C
Dims. (L x W x H) mm	594 x 381 x 373 mm	712 x 452 x 440 mm	714 x 447 x 467 mm
Weight (app.)	13 kg	20 kg	22 kg
Colour	Matte Black / Matte Blue		
Item no.	71375	71371	71372
Price	466,65	551,65	619,65

Thermal bag for MaxiFreezer 40 and 50

Item no.	-	713710	713720
Price	-	42,42	46,71

Connection cable UK for MaxiFreezer 40 + 50.

713711 5,87



Delivery in each case without content



The robust thermal protection bag additionally insulates the cool box and also protects it from dust, dirt and splash water. Optionally available for MaxiFreezer 40 and 50.

COMFORTSLIDER M + L FASTENING PULL-OUTS FOR COOL BOXES

- Solid powder coated metal frame
- Safety lock
- Including 4 lashing straps and mounting material
- ComfortSlider M, extension app. 760 mm.
For coolers with a size of max. LxW 740x410 mm.
Ideal for the following Carbest coolers:
71469/71456/71457/71458/714102/714103/71375
- ComfortSlider L, extension app. 900 mm. For coolers with
a size of max. LxW 910x530 mm. Ideal for the following
CARBEST cool boxes: 71371/71372/71373

Thanks to the universal pull-out rails, your cooler can be pulled out of vehicle for convenient loading & unloading. A safety lock ensures that the rail is firmly anchored in the pushed-together position during travel. **Scope of delivery:** Fastening pull-out, 4 lashing straps w/ which the cooler can be secured (on lashing eyes) to pull-out frame, mounting material. Without cooler.

- ① **ComfortSlider M - loadable up to 120 kg**
Dimensions (LxWxH) Outside: 790x480x65 mm, Inside:
740x410 mm Weight: approx. 12.8 kg **71498 199,-**
- ② **ComfortSlider L - loadable up to 120 kg**
Dimensions (LxWxH) outside: 960x600x65 mm, inside:
910x530 mm Weight: approx. 16 kg **71499 219,-**

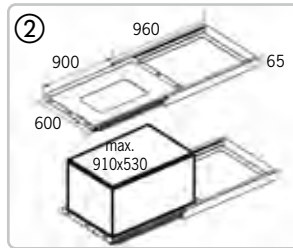
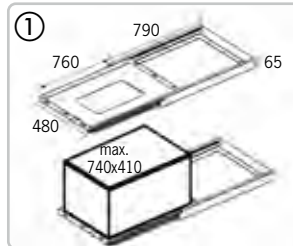

Application example
Supplied without cooler.



DRAWER SLIDES

Rollout Slider Giant

The heavy-duty full extension rails with mechanical locking

Material: steel. Loadable up to max. 227 kg. Not detachable.

559 mm, pair	533000	84,96
711 mm, pair	533001	118,96
965 mm pair	533002	179,90

Angle for mounting full extension:

559 mm, 2 pieces	533004	23,95
711 mm, 2 pieces	533005	29,95
305 mm, piece	533003	12,95

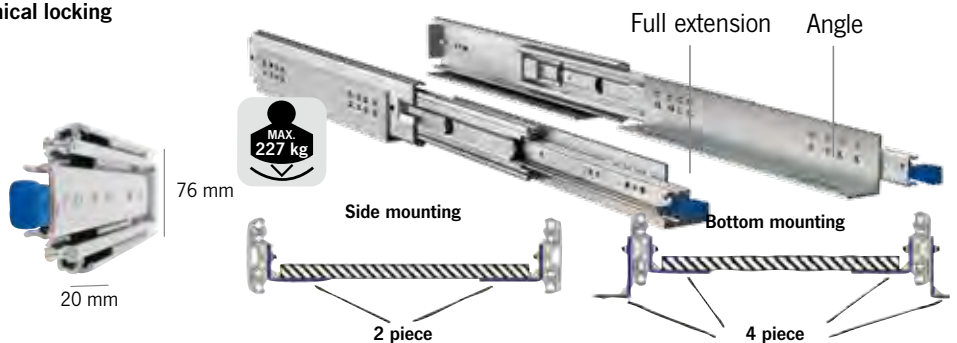

① Full extension up to max. 110 kg

Soft-roll extension, load capacity up to 110 kg.
Not detachable. 2 pieces in a set. Material: steel.
Length: 700 mm.
2 piece **533006 69,90**

② Full extension up to max. 400 kg

Extendable in both directions and extremely resilient
up to a maximum of 400 kg. 2 pieces in a set.
Material: steel. Length: 930 mm.
2 piece **533803 254,92**



Image similar



CV50L COMPRESSOR REFRIGERATOR FOR CAMPER VANS

12V / 24V
46,5 LITER
DOOR HINGE RIGHT
PLASTIC FRONT
LED DISPLAY INSIDE
ECE R10

• Door hinge right (not changeable)

Usable capacity total	46,5 l
Refrigerator/freezer	42 l / 4,5 l
Ø Current consumption	12 V: 5.0 A / 24 V: 2.6 A
Ø Power consumption	40 W
Temperature range	
Refrigerator/freezer	+15 °C to +5 °C / -18°C
Weight	app. 17 kg
Item no.	713572
Price	679,-

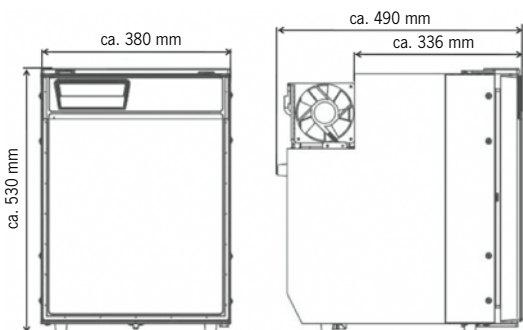

Order right away

Suitable mounting frame

Material: aluminum, colour silver metallic. **713572** **52,-**



WxHxD Freezer comp.: app. 280x110x120 mm



LED display in refrigerator



Compressor integrated in housing



These refrigerators are designed for installation in vehicles only.



Delivery without content

LR40L + LR50L + LR90L COMPRESSOR REFRIGERATORS



- 12V
24V
- DOOR
HINGE
LEFT/
RIGHT
- VENT-
POSITION
- LED
DISPLAY
- NIGHT
MODE
- VERY
SMALL
DESIGN
- E
ECE R10

- Front design: Brushed black
- Door hinge left or right freely selectable
- LED display
- Night Mode: Lower noise level, reduced power consumption and unlit display during the night for better sleep
- Integrated "Vent Position System" prevents bad odors and mold growth when not in use
- Brand compressor from LG
- Front panel for the refrigerator door in brushed silver optionally available



Regular display

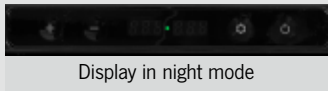

Display in night mode



Optionally available front panel for the refrigerator door in brushed silver (Fig. shows LR40L)



These refrigerators are designed for installation in vehicles only.



Model LR40L	
Total useful capacity (liters)	35,8 L
Refrigerator/freezer	31.7 L / 4.1 L
Ø Power consumption (12/24V)	5.0A / 2.5A
Ø Power consumption	60 W
Temperature range Refrigerator/freezer	+8° to 0°C / -20°C
Control panel	LED display
Door stop	Left or right
Relocatable compressor unit (L 375 x D 180 x H 150 mm)	Yes (1.5 m long supply cable)
Dims. WxHxD in mm	380x532x369/550
Weight	18 kg
Colour	Black
Item no.	713505
Price	519,-



4.1 L freezer comp.



Vegetable comp. w/ door



The removable compressor unit can be installed offset to the refrigerator thanks to a 150 cm long supply line. (Compressor unit on mounting plate: approx. L 375 x D 180 x H 150 mm)

Front panel for refrigerator door in brushed silver	
Item no.	7135051
Price	22,90

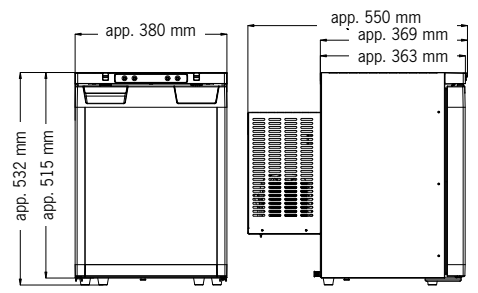

Delivery in each case without content

Model LR50L	
Total useful capacity (liters)	43,7 L
Refrigerator/freezer	40.6 L / 3.1 L
Ø Power consumption (12/24V)	5.0A / 2.5A
Ø Power consumption	60 W
Temperature range Refrigerator/freezer	+8° to 0°C / -20°C
Control panel	LED display
Door stop	Left or right
Movable compressor unit	No
Dims. WxHxD in mm	380x532x482
Weight	18 kg
Colour	Black
Item no.	713506
Price	539,-



Front panel for refrigerator door in brushed silver	
Item no.	7135061
Price	22,90

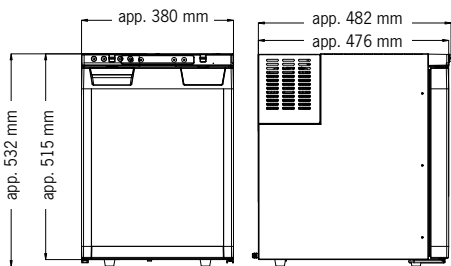

Model LR90L	
Total useful capacity (liters)	91,4 L
Refrigerator/freezer	82 L / 9.4 L
Ø Power consumption (12/24V)	6.0A / 3.0A
Ø Power consumption	80 W
Temperature range Refrigerator/freezer	+8° to 0°C / -20°C
Control panel	LED display
Door stop	Left or right
Movable compressor unit	No
Dims. WxHxD in mm	419x976x482
Weight	26 kg
Colour	Black
Item no.	713507
Price	669,-



Front panel for refrigerator door in brushed silver	
Item no.	7135071
Price	22,90

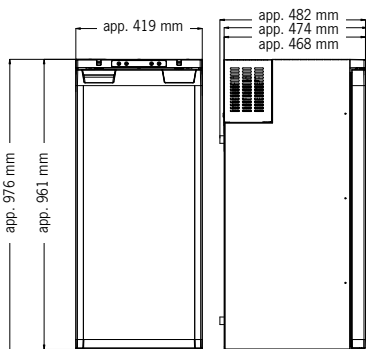

Delivery in each case without content

MOBILE SPLIT AIR CONDITIONER



**NEW
2024**



Free app

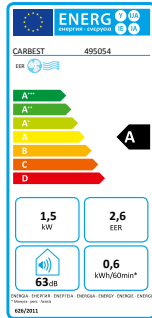

- With mounting bracket for installation in the window opening of the motorhome or caravan
- Adjustable temperature (16-30°C)
- LED display with 24-hour timer & night mode
- WiFi control (free app)
- Low noise level in sleep mode (app. 44 dB)
- Large ventilation opening for maximum comfort
- Integrated handles for easy transportation

Powerful split air conditioning system w/ a cooling capacity of 5000 BTU/h (1465 W) cools, ventilates & ensures pleasant temperatures in vehicle. The air conditioning unit consists of an indoor and an outdoor unit and is simply hung in the window opening. A flexible connecting hose (length: 550 mm) connects the two units.

Technical data:

- Input voltage: 220 - 240 V / 50 Hz
- Cooling capacity: 5000 BTU / h (1465 W)
- Power consumption: 560 W / Current consumption: 2.5 A
- Air flow rate: 140 - 200 m³ / h
- Noise level: 46 dB (sleep mode: 44 dB)
- Housing colour: white, weight: app. 21 kg

Scope of delivery:

Split air conditioning system, mounting bracket (for indoor & outdoor use), rubber damper, drain hose, protective hose, installation instructions-material, operating instructions.

495054 649,-

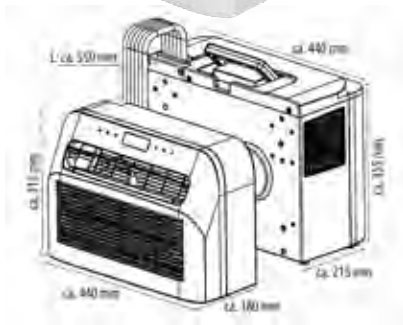

COOLSKY AIR CONDITIONERS

- 220-240 VOLT
- 2600 W / 3300 W
- HEAT & COOL
- INCL. AIR DISTRIBUTION UNIT
- LED DISPLAY
- INCL. REMOTE CONTROL
- ROOF CUTOUT 40x40 cm
- DACH-THICKNESS 26 UNTIL 100 mm
- ECE R10
- Truck and Caravan icons

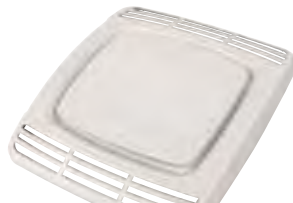

White air distribution unit with LED display

- Cooling and heating in one unit
- Air distribution unit included
- Simple control via remote control or LED display on the air distribution unit
- Aerodynamic due to very flat design
- Powerful and yet very quiet in operation
- Type approval according to UN ECE R10

With the CARBEST roof air conditioners, you not only cool the living space in your motorhome or caravan on hot days, but can also enjoy a cozy warmth in your vehicle on cold days thanks to the heating function.

The 2600 watt air conditioning system is suitable for vehicles up to 7 m in length. The system with 3300 watts of power is suitable for vehicles from 7m in length.

The air conditioners consist of a white or black outdoor unit and a white air distribution unit (dims: LxW 540x490 mm). The air distributor can be controlled via the LED display or conveniently by remote control.



Technical data	2600 watt	3300 watt
Cooling capacity	2600 W / 9000 Btu/h	3300 W / 12000 Btu/h
Heating capacity	2800 W / 9500 Btu/h	3400 W / 12500 Btu/h
Input voltage	220-240 V/50 Hz	220-240 V/50 Hz
Current consumption cooling/heating mode (max.)	5.5 A/4.9 A	7.6 A/7.0 A
Dims. outdoor unit (L x W x H)	1056x736x253 mm	1056x736x253 mm
Dims. air distributor (L x W x H)	540x490x72 mm	540x490x72 mm
Roof cutout	400x400 mm	
Roof thickness	26-100 mm	
Weight incl. air distribution unit	app. 53 kg	app. 57 kg
Colour white matte	495003 1729,-	495004 1799,-
Colour black matte	4950031 1729,-	4950041 1799,-

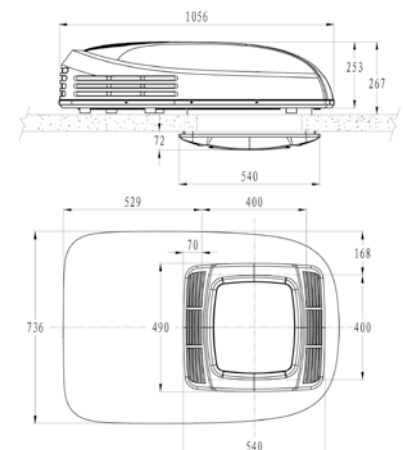

VANHEAT 2.0-DH + 4.0-DH POWERFUL 12 V DIESEL PARKING HEATERS

12V
DIESEL
INCL. LCD DISPLAY
HEIGHTS KIT BIS 5.000 m
APPROVAL BY KRAFTFAHRT-BUNDESAMT
ECE APPROVAL



Scope of delivery: Diesel parking heater, LCD control panel, fuel pump, fuel tank extraction set and extensive installation material.

- Integrated altitude adjustment up to 5,000 m
- Control via supplied LCD control panel
- Type approval according to UN ECE R122
- Approval by Federal Motor Transport Authority according to UN ECE R10
- Extensive mounting material included

The 2 kW diesel parking heater is ideally suited for vans, camping buses & smaller motorhomes, the 4 kW heater for larger camping buses & motorhomes. Control takes place via a digital operating element. The altitude adjustment (Alpine Kit) is already integrated in the housing and enables smooth operation in high mountains up to 5,000 m.

VanHeat	① 2.0-DH (2 kW)	② 4.0-DH (4 kW)
Heating cable	2000 W	4000 W
Rated voltage	12 Volt DC	12 Volt DC
Ø Power consumption (app.)	10 – 29 W	8 – 34 W
Fuel consumption (app.)	0.12 - 0.24 l/h	0.11 - 0.51 l/h
Dims. (LxWxH)	323x120x121 mm	371x140x150 mm
Weight heater (app.)	2,6 kg	4,5 kg
Item no. / Price	48182 649,-	48183 699,-

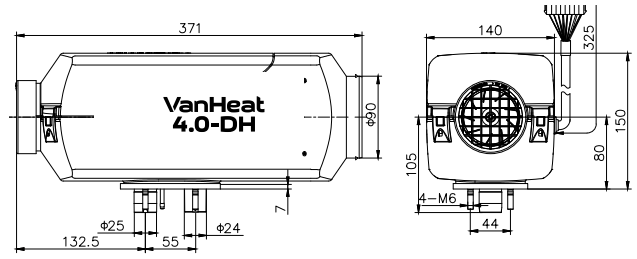
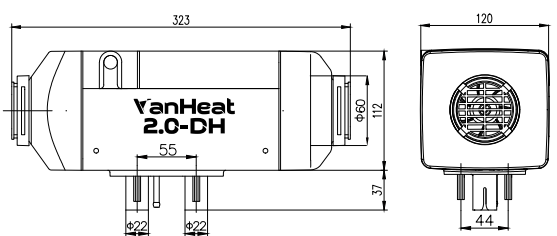

Optional accessories:

① **External temperature sensor**
Compatible with all VanHeat heaters.
Cable length: 4m.
48187 29,95

② **Exhaust silencer For VanHeat 2.0-DH:**
Ø Connection: 22 mm
481870 31,60
For VanHeat 4.0-DH:
Ø connection: 24 mm
481871 31,60

③ **12V radio remote control**
range up to 1,000 m. Frequency range: 868 MHz. Scope of delivery: handheld transmitter (IP68), receiver & ext. antenna.
48014 279,-

④ **Mounting bracket for VW T5/T6, especially for VanHeat 2.0-DH**
For mounting the VanHeat 2.0-DH under the passenger seat in the VW T5/T6. High accuracy of fit and quick assembly. Material: aluminum black coated
481821 49,95

⑤ **Underfloor installation box especially for VanHeat 2.0-DH**
Provides optimum protection against weather influences for underfloor installation. Material: aluminum black coated
481822 199,-



SMART TVs POWERED BY ANDROID

12~30 VOLT 100~240 VOLT DVB-T2 DVB-S2 DVB-C H.265 DVB-T2

HDMI USB 2.0 CI+ SLOT MPEG4

WIFI SCART VGA VIDEO TEXT HEVC 10 bit

- For a smooth multimedia experience
- WiFi, DVB-S2 (SAT), DVB-C (Cable), DVB-T2 with HD (Terrestrial)
- Wide viewing angle
- Extra slim housing
- Android system



Devices type	18.5" HD READY	21.5" FULL HD	23.6" FULL HD	27" FULL HD
Screen format	16:9 widescreen format			
Viewing angle	178 / 178	176 / 176	178 / 178	178 / 178
Operating voltage	12V DC / 24V DC / 230V AC			
TV connections IN	1x HDMI, 2x USB 2.0, 1x VGA, 1x PC audio, 1x CI+ slot, 1x AV, 1x RJ45			
TV connections OUT	1x coaxial, 1x headphone			
Power consumption operation/standby	<36 W / <0.5 W			<48 W / <0.5 W
Resolution (pixels)	1366 x 768	1920 x 1080		
Contrast	3000:1	4000:1	3000:1	3000:1
Brightness (cd/m2)	200	200	200	240
Energy efficiency	F	F	F	F
Dims. (mm): w/o. base, WxHxD	436 x 259 x 43	502 x 297 x 45	551 x 327 x 43	638x379x45/62
Dims. (mm): w/ base, WxHxD	436 x 304 x 160	502 x 342 x 160	551 x 369 x 180	638x416x187
Weight (without foot)	1,9 kg	2,3 kg	2,8 kg	3,8 kg
Scope of delivery	LED TV, stand/feet, power supply 100-240V, car adapter 12-30V with cigarette lighter plug, remote control, manual			
Item no. / Price	49881 269,-	49883 299,-	49885 325,49	49886 339,15

We reserve right to make technical improvements / changes, as well as to supply a qualitatively comparable product from another manufacturer or supplier in each case. The images are similar to delivered products. Dimensions without guarantee.

* Please note our warranty conditions on page 114.

TV WALL MOUNT SIMON LUXUS WITH LOCK SUITABLE FOR MANY TVS

For
15" - 20"
TVs



Black glossy
or silver

- Knurled screws for quick fixation
- For screens from 13" to 30"
- Perforated rim 75 and 100 mm (VESA)

① TV Holder Simon Luxury

Secure locking while driving. Arm length 175 mm each. Length folded out 430 mm. Load capacity: Max. 10 kg. Weight: approx. 1 kg. Material: Aluminum

Silver	493960	69,95
Black glossy	493983	69,95

② TV holder Simon Luxus XL

Like TV- Holder Simon Luxus, but arm length 285 mm each. Length folded out 650 mm. Load capacity: Max. 10 kg. Weight: approx. 1.4 kg. Material: Aluminum

Silver	493970	79,95
Black glossy	493984	79,95

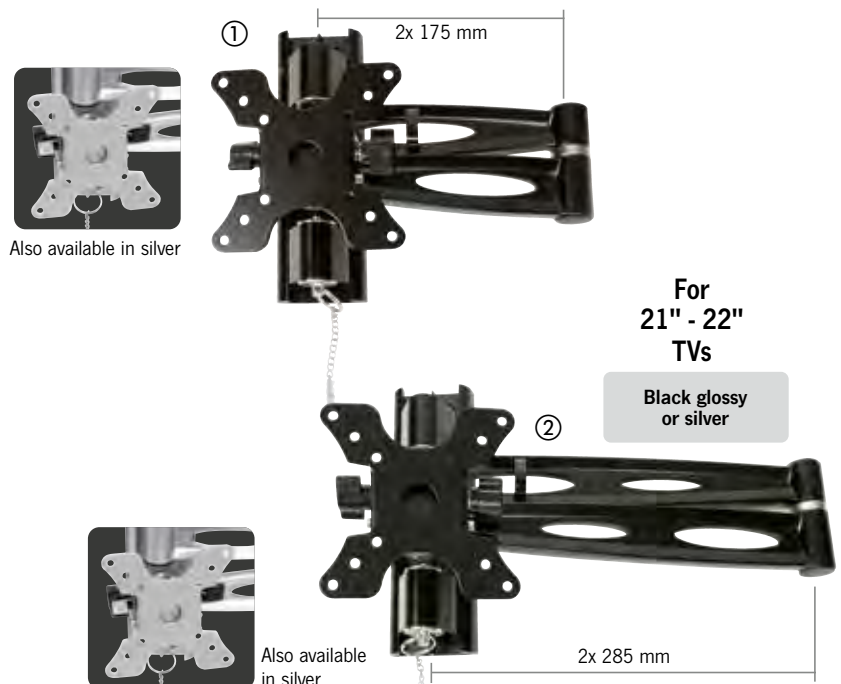

TV WALL HOLDERS WALL MOUNT

- Knurled screws for quick fixation
- For screens from 13" to 30"
- Perforated rim 75 and 100 mm (VESA)

① Wall Mount TV Holder S

load capacity: Max. 10 kg
Dimensions: 114 x 114 x 98 mm
Weight: 0.6 kg, Material: aluminum

Silver	493962	29,95
matt black	493980	29,95

② Wall Mount TV Holder M

load capacity: Max. 10 kg
Dimensions: 116 x 152 x 81 - 235 mm
Weight: 0.8 kg, Material: aluminum

Silver	493961	47,95
Black matte	493981	47,95

③ Wall Mount TV Holder XL

Load capacity: MAX.10 kg.
Dimensions: 116 x 152 x 81 - 390 mm
Weight: 1 kg, Material: aluminum

Silver	49396	49,95
Black matte	493982	49,95

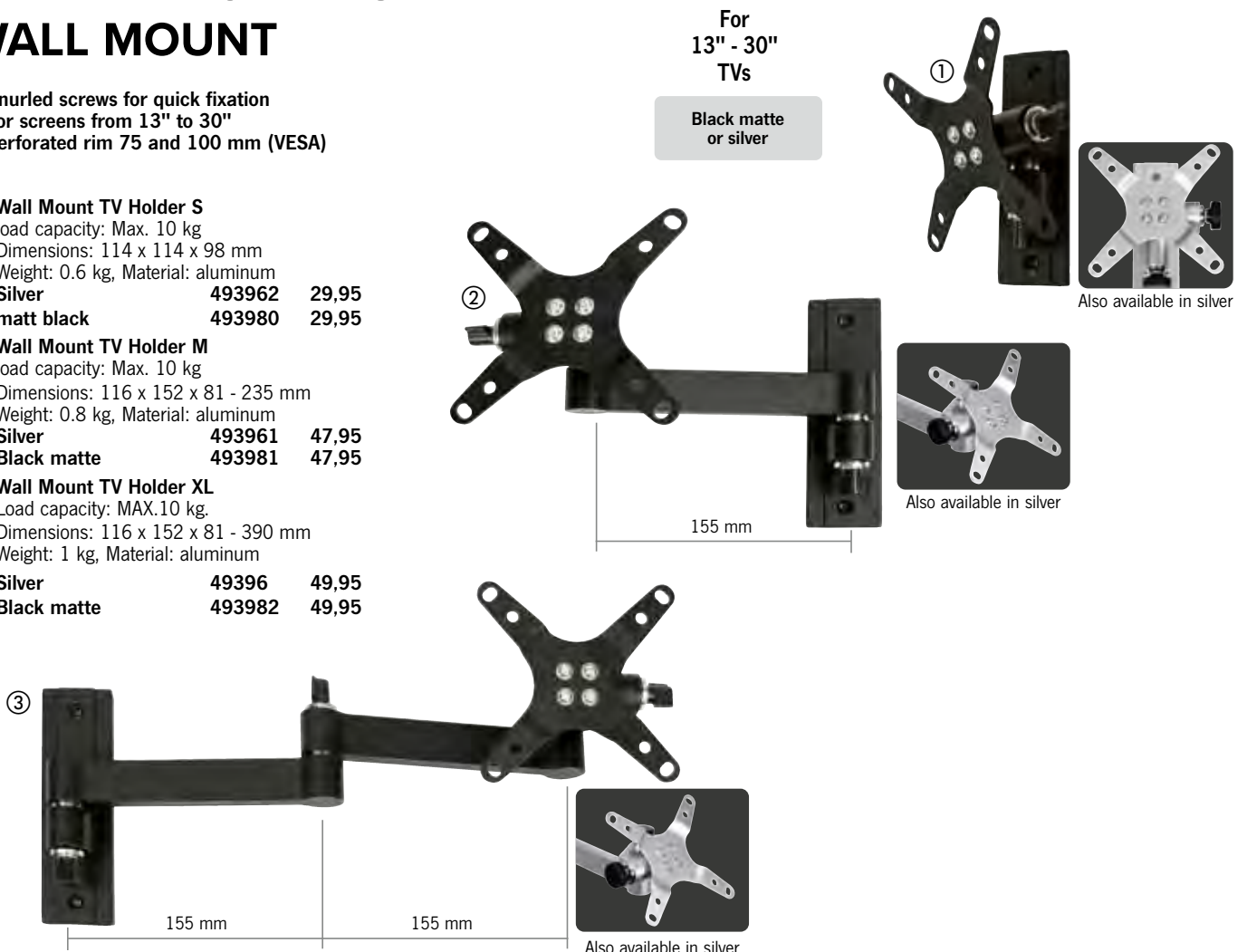

TRAVELSAT 68 II AND 80 II

PREMIUM SAT SYSTEMS WITH BLUETOOTH CONTROL CONVENIENT VIA SMARTPHONE

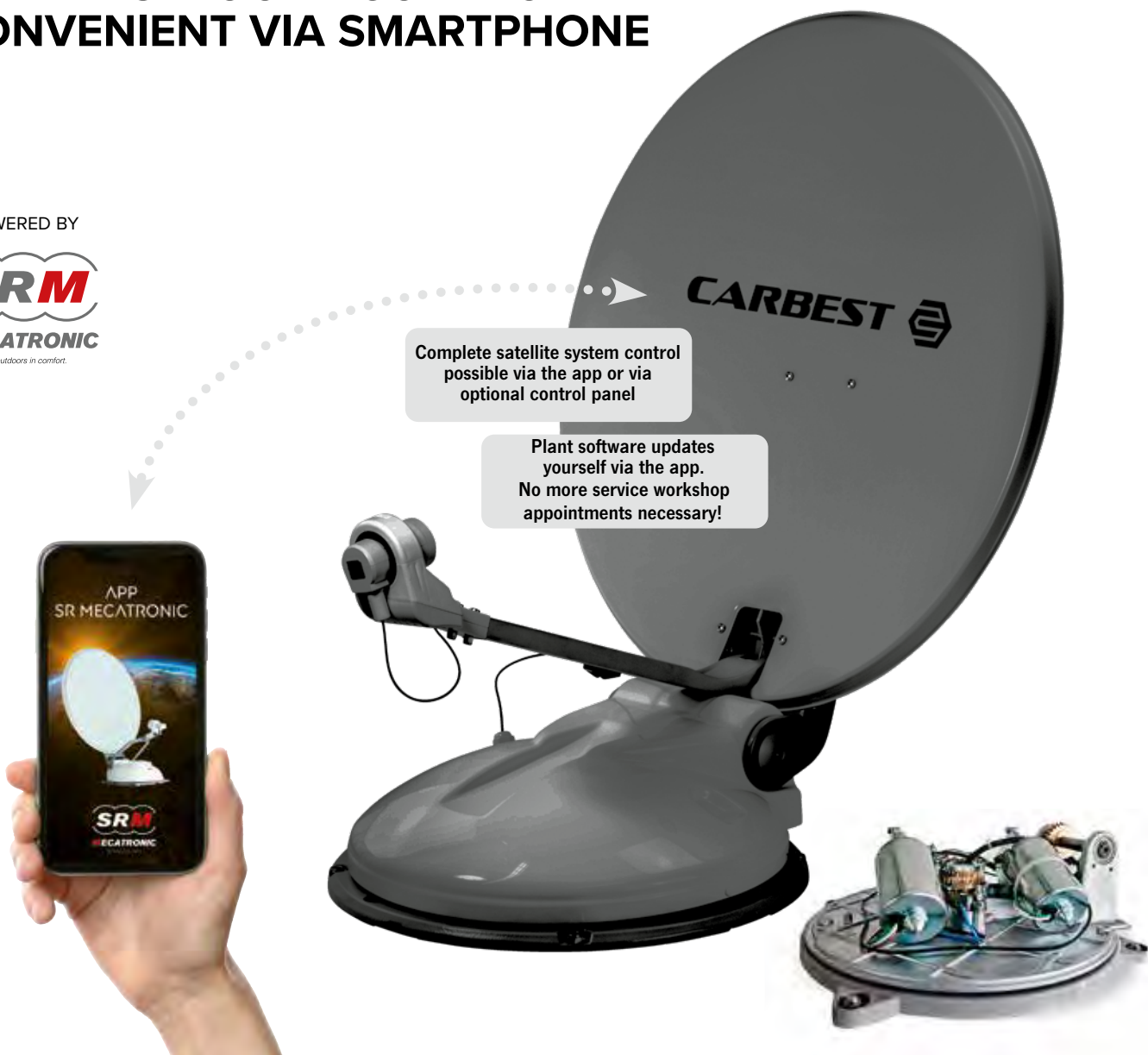

Proven Travelsat quality now with Bluetooth technology!

- All antennas with Bluetooth technology
- Convenient operation via smartphone: simply carry out software updates yourself via app, no more annoying workshop appointments
- Powerful LNBs for excellent TV reception even in outlying areas
- Powerful rotating mechanism and robust metal and aluminum components for a long service life and quiet operation

Technology: Travelsat II series w/ state-of-the-art hardware & software technologies. Easy to update & future-proof: HD & DVB-T2.

Control unit: The system is compatible with all decoders (including Sky HD). Reprogrammable software connection without opening the box.

Positioning: Quick search of the satellite position. Thanks to GPS, the search time is about 30-60 sec, 5-10 seconds when changing satellites. Automatic satellite alignment at the touch of a button. 1, 7 or 15 preset satellites. Saves the last recorded position. Acoustic signal warns when vehicle is started if antenna is open (plus).

Details: Aluminum mounting plate for secure and easy attachment to the vehicle. High-precision gearbox made of steel & bronze: long service life with minimal maintenance.

Technical data: 12 volts/27 watts (max. 48 watts when retracting and extending), -15°C to +50°C. With CI slot (Common Interface), OSD.

Scope of delivery: Outdoor antenna, control unit without receiver, cable, cable entry, mounting material, mounting plate and instructions.

Travelsat II Ø 68 cm with Bluetooth Control unit

ASTRA Single system (for 1 receiver)

All other satellites can be selected via app or control panel.

Colour anthracite 496380 1399,-
 Colour white 49638 1399,-

Travelsat II Ø 68 cm, ASTRA Twin system (for 2 receivers)

All other satellites can be selected via app or control panel.
 Colour white 49639 1519,-

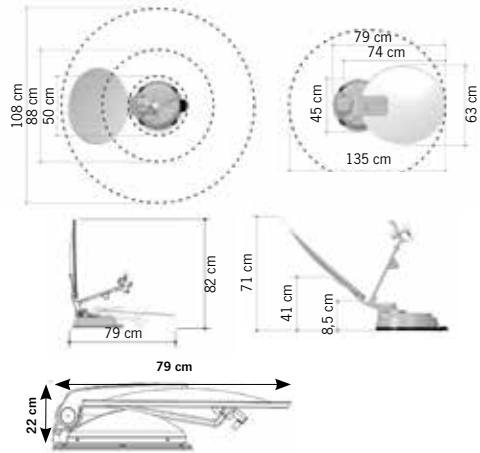

Travelsat II Ø 80 cm with Bluetooth Control system

ASTRA system with Bluetooth. All other

Satellites selectable via app or control panel.

Single system (for 1 receiver) with Bluetooth 49640 1569,-

Single system (for 1 receiver) w/ Bluetooth & Skew 49641 1999,-

Twin system (for 2 receivers) with Bluetooth 49642 1699,-

Twin system (for 2 receivers) w/ Bluetooth & Skew 49643 2199,-

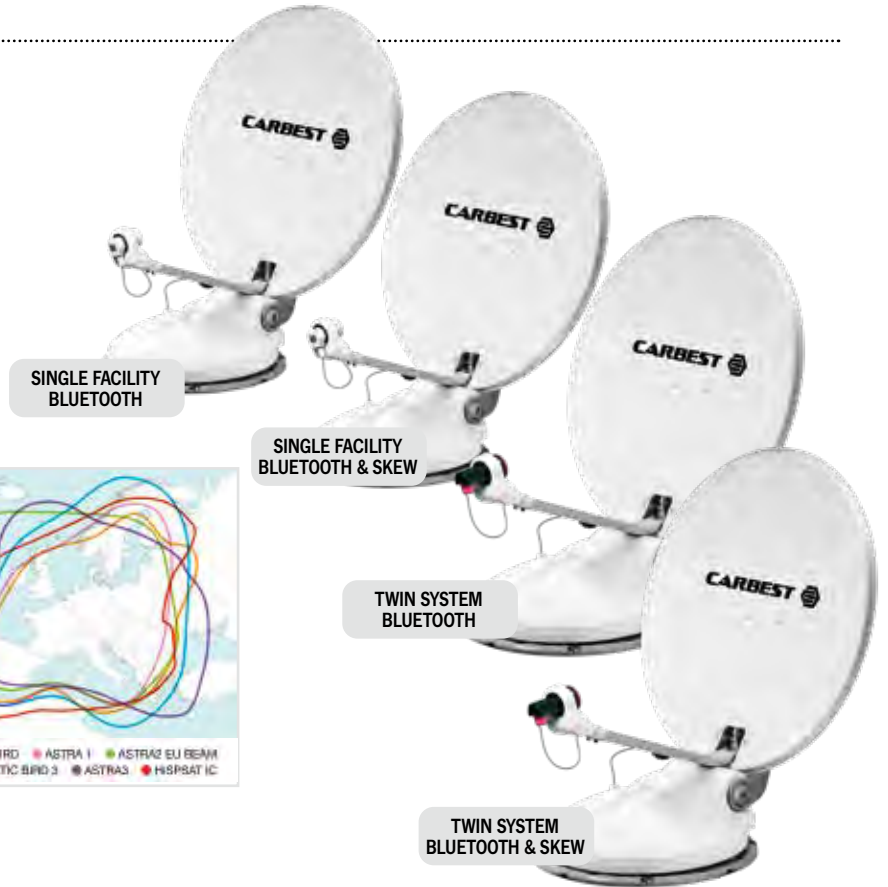
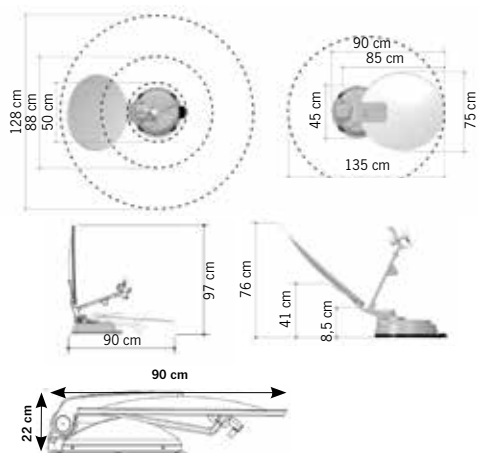

TWIN system: The twin system has a second SAT connection for an additional digital or HD receiver, e.g. for a TV in the sleeping area. This allows independent program selection on both Connections (receiver not included).

Service: The comprehensive SR-Mecatronic service network ensures fast repair or replacement in case of service. This means that the Travelsat is quickly ready for use again.

Optional control panels: As an alternative to Bluetooth control, there are 2 control panels to choose from: The LED control panel with 7 pre-programmed satellites and the comfort "Plus" LCD control panel with 15 pre-programmed satellites.



LED control panel 7 pre-programmed satellites:

Hotbird 13E, Astra 19, Thor, Sirius, Atlantic Bird, Hispasat, Astra 28.
 49724 149,-



Comfort "Plus" LCD control panel. 15 pre-programmed satellites and additional functions:

Hotbird 13E, Astra 19E, Astra 28E, Eurobird 16E, Thor 1W, Sirius 5E, Atlantic Bird 5W, Hispasat 30W, Eurobird 9E, Eutelsat 7E, Eutelsat 10E, Amos 3W, Atlantic Bird 8W, Atlantic Bird 12W, Astra 23.5E.
 49725 179,-

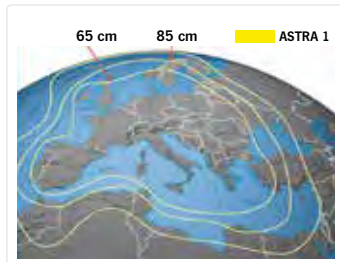

MULTISAT

SATELLITE ANTENNA MULTI-SAT X85 TWIN + SKEW 10 SATELLITES PRE-PROGRAMMED

12V	Ø 85 CM	SINGLE LNB	AUTO SKEW	GPS RECEIVER
10 SATELLITES PRE-PROGRAMMED	AUTOMATIC RETRACTION AT VEHICLE START	SATELLITE SEARCH RUN: APPROX. 180 SEC.	DiSEqC 1.0/1.1	COLOUR: WHITE

Technical data: 10 satellites pre-programmed, input frequency: 10.7~12.75 GHz, output frequency: 950~2,150 MHz, polarization: vertical and horizontal, angle range elevation: 0°~145°, angle range azimuth: 390°, power supply: DC 12 Volt, operating temperature: -20° C to +60° C. Scope of delivery: Multi-Sat antenna, controller, roof feed-through, mounting plate, LNB protective film, connection cable, screws, operating instructions.

Turksat, Astra 2, Astra 3, Astra 1, Hotbird, Eutelsat 9, Astra 4, Thor, Eutelsat 5W, Hispasat, compact but still great reception, satellite search time max. 180 seconds, software update via USB, dimensions retracted: 110.5 x 86 x 18.4 cm, weight: approx. 14 kg

49633 1274,15

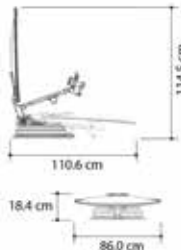
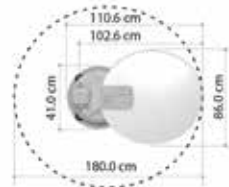
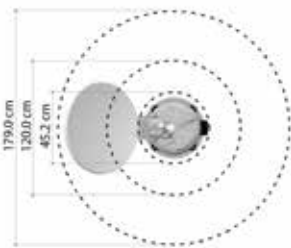

SNIFE PRO MAX

- Active GPS receiver for short search times (1-2 min.)
- Automatic SKEW function
- Extremely flat, robust aluminum housing (only 22.2cm high)
- 10 satellites pre-programmed, selectable on external control panel
- Extra reinforcement for high wind loads

Comfort functions of Snipe PRO MAX:

Wide angle for reception in Southern & Northern Europe (5 - 90°). Automatic retraction when vehicle is started. Auto-update of transponder data via satellite keeps Snipe always up to date. W/ DVB-S2 also ideally suited for HD television. Subject to technical changes.

Technical data:

1-participant universal LNB. Frequency range: 10.7 - 12.75 GHz, Frequency band: Ku Band, Polarization: linear (horizontal/vertical), Reception power: 50 dBW, Antenna gain: 36.1 dBi, Angle ranges: Azimuth: 360°, Elevation: 5° ~ 90° skew: -60°/+60°. Temperature range: -20 to +60°C. Voltage range 12 to 24 volts. Power consumption: max. 75 W (search process)

10 satellites pre-programmed:

Astra 1, Astra 2, Astra 3, Astra 4, Hotbird, Thor, Eutelsat 5 West A, Türksat, Hispasat, Eutelsat 9A.

Scope of delivery:

Antenna, control unit, bracket for control unit, 12 V connection cable, 12 m coaxial cable for receiver and control unit, roof cable entry, mounting plate and manual instructions.

Space requirement with maximum rotation range of the antenna: approx. 640 mm. (LxWxH): 51.1 x 63.8 x 24.6 cm, antenna closed: H: 24.6 cm. Weight: 16,5 kg

48296 1080,-



12V
24V HD



Illumination zones Snipe Pro Max



H: 22.2/24.6 cm

Can be used with any satellite receiver

SNIPE HANDY

PORTABLE SAT SYSTEM INCLUDING ANTI-THEFT DEVICE

12V 24V	SINGLE LNB	4 SATELLITE PRE-PROGRAMMED	1-CABLE CONNECTION	WITH THEFT- SECURITY
--------------------------	-----------------------------	---	-------------------------------------	---

- Small, lightweight, portable, no fixed mounting required
- Perfect for mobile use: antenna can be placed anywhere with a clear view of satellite
- Single LNB, 4 satellites pre-programmed (Astra1, Astra2, Hotbird, Eutelsat 5W)
- Integrated theft protection (optical & acoustic)

The robust plastic hood provides the best possible protection against weather influences. The carrying handle facilitates transport. 1-cable connection: connection of the antenna to the controller incl. power transmission via coaxial cable. Incl. Radio remote control. Satellite search time: approx. 180 sec., power consumption: 30W. Signal gain: 31 dBi, reception power: 51 dBW, search angle: 15° - 90°/360°, Metal eyelet for fixing a steel cable against theft. In addition, acoustic warning signal in case of non-permitted removal of the coaxial cable. Approx. dimensions: Ø 450mm, H 390 mm. (Delivery without steel cable)

49796 758,48

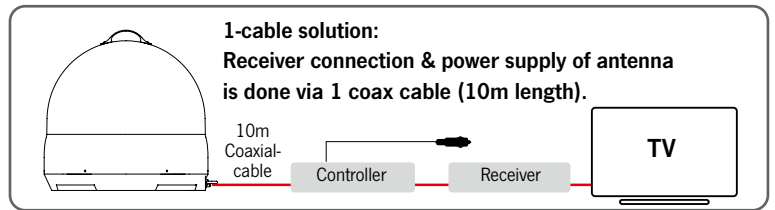
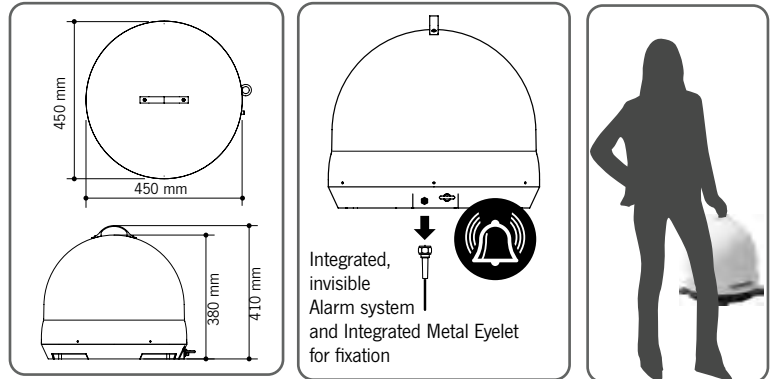

ACTIVE DVB-T2 CIRCULAR ANTENNAS FOR OUTDOOR, CAR OR CAMPER

- Reception of regional digital programs
- Integrated amplifier
- Concealed cable routing (through antenna base)

DVB-T2	12V 24V
---------------	--------------------------

Antenna with the latest SMD technology. Excellent reception of digital terrestrial TV (DVB-T) and radio programs (DAB Radio). Reception of local/regional FM radio signals. With built-in amplifier. Extremely wide frequency range. Weatherproof, rustproof, design w/ aluminum base.

Technical data:
Frequency ranges: FM 87.5-108 MHz, VHF 174-230 MHz, UHF 470-862 MHz. Opening angle: vertical 90°/horizontal 360°. Output level: Max. 108 dB, Gain: 35 dBi, Input voltage: DC12/24 V, operating voltage: 5 V DC, connection: F-plug. Dimensions: Ø foot: 13 cm, Ø antenna: 30 cm, total height: 20 cm

49410 109,90



Cable routing through aluminum base

TELESCOPIC ANTENNA MAST

- Allows easy adjustment of the antenna without leaving the vehicle
- Suitable for motorhomes and caravans
- Reliably protected from water ingress
- Made of anodized corrosion resistant aluminum

Total length: 50 cm, Ø 30 mm. Double O-ring system reliably protects against water ingress. Weight: app. 0.5 kg.

492410 53,90



BACKMIRROR WITH INTEGRATED MONITOR

For safe parking and shunting.

Compatible with all cameras on the right side

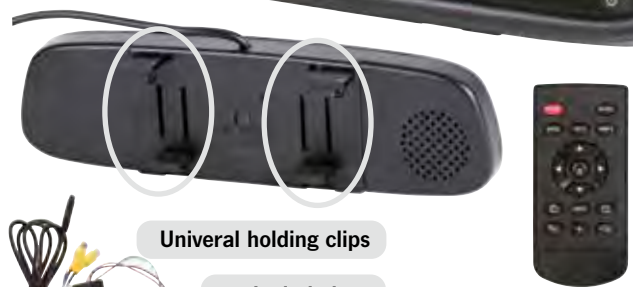

Fiat Ducato 290/Citroën Jumper mirror base

Included Connection cable



Universal holding clips

Included Connection cable

- 12 VOLT
- TOUCH SCREEN
- 4,3" LCD
- DVB-T2
- 480x272 PIXEL
- 2x VIDEO INPUT
- PAL/NTSC
- ECE R10

Rear-view mirror with integrated 4.3" monitor suitable for Fiat Ducato290/ Citroën Jumper mirror base

Rear view mirror with integrated 4.3 inch monitor suitable for Fiat Ducato 290 and Citroën Jumper mirror base, automatic activation with reverse gear, adjustable guide lines, 2 x video input, resolution: 480 x 272, control via touch screen, remote control, video system: PAL/AUTO/NTSC, Emark certified, dimensions: approx. 27 x 7.5 cm

47820 149,-

Rear view mirror with integrated 4.3" monitor, universal clip-on bracket

Universal rear-view mirror with integrated 4.3 inch monitor, clip-on version, automatic activation with reverse gear, adjustable guide lines, 2 x video input, resolution: 480 x 272, control via touch screen, remote control, video system: PAL/AUTO/NTSC, Emark certified. Dimensions: ca.27x7,5cm

47821 130,01

HIGH QUALITY BRAKE LIGHT CAMERAS

- High resolution cameras
- Plug & Play Installation
- Night mode with night vision IR LEDs (except 47811 + 47813)
- 10 m connection cable included
- All brake light cameras are ECE R10 certified
- Compatible with the rear view mirrors on the left side



Connection cable included w/
all brake light cameras



Compatible with the
rear view mirrors
on the left side

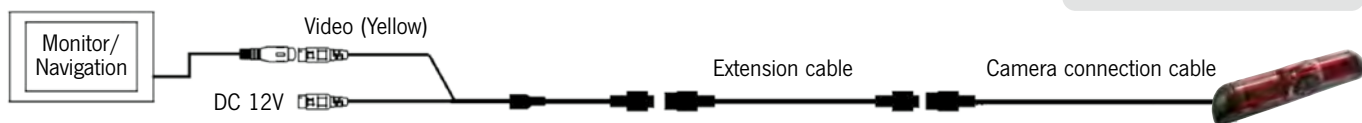

Model	① Fiat Ducato / Peugeot Boxer / Citroën Jumper etc. > 2006	② Volkswagen Caddy	③ Volkswagen Crafter > 2017	④ Volkswagen T6 > 2016 with large tailgate
Camera system	1/3 CMOS	1/3 CMOS	1/3 CMOS	1/3 CMOS
Resolution (HxV)	720x480 Pixel	960x576 Pixel	960x576 Pixel	960x576 Pixel
TV system	PAL	PAL	PAL	PAL
Protection class	IP68	IP69	IP69	IP69
Viewpoint	160°	170°	170°	170°
Horizontal resolution	600 TVL	700 TVL	700 TVL	700 TVL
IR LEDs	6 LEDs	-	9 LEDs	-
Power supply	DC 12V	DC 12V	DC 12V	DC 12V
Operating temperature	-20°C - +70°C	-30°C -s +70°C	-30°C - +70°C	-30°C - +70°C
Energy consumption	< 3 W	< 3 W	< 3 W	< 3 W
Built in lens	2,6 mm	2,8 mm	2,8 mm	2,8 mm
Connection cable, length	10 m	10 m	10 m	10 m
Housing dimensions	app. 26 x 5,5 cm	app. 17,5 x 4 cm	app. 53 x 17,5 cm	app. 33.5 x 2.5 cm
Item no.	47800	47811	47812	47813
Price	179,-	44,49	152,15	109,65

RADIO REAR VIEW CAMERA SYSTEM FOR MOTORHOMES AND CARAVANS

12/24 V

RADIO-SYSTEM

CABLE-LESS ASSEMBLY

SHORT INSTALLATION-TIME



The rear view camera system transmits the rear view camera image wirelessly via radio to a monitor in the driver's cab (radio range max. 10 m). Radio range also suitable for larger motorhomes and caravans. Wireless installation reduces the installation time in the vehicle. Operation via 12 V or 24 V possible. Digital 2.4 GHz radio transmission. **Scope of delivery:** 1 receiver, 1 transmitter, incl. adapter for reversing systems. **47439 84,96**



Cable tie

For quick attachment of hoses or cables. Plastic, assorted colours. Dimensions: 200 x 3.5 mm, 100 pcs.

810780

3,90



Adhesive base for cable ties, 50 pcs.

Plastic base, back with 3M adhesive tape. For cable ties up to a maximum width of 6 mm. Colour: black. Dimensions: 20 x 20 mm.

Cable ties not included in the scope of delivery.

810800

4,99

STAINLESS STEEL GAS HOBS

WITH
IGNITION-
FUZE

STAIN-
LESS
STEEL

30
mbar

CE

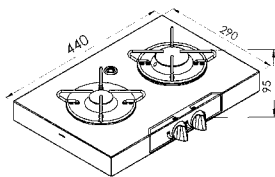

① Surface mounted gas hob - 2-burner stainless steel

- 2 flame, with ignition fuse
- Stainless steel surface
- 1x 1,8 kW, 1x 1,0 kW

Control element at the bottom, 2-burner, manual ignition, power: 1x 1.8 kW, 1x 1.0 kW, gas consumption: 204 g/h, 30 mbar, Dimensions: WxDxH 440x290x95 mm. Weight: 2,5kg. Scope of delivery: Gas hob incl. installation accessories **70563 219,-**

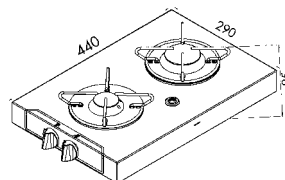

② Surface mounted gas hob - 2 stainless steel burners

- 2 flame, with ignition fuse
- Stainless steel surface
- 1x 1,8 kW, 1x 1,0 kW

Bottom control element, 2-burner, manual ignition, power: 1x 1.8 kW, 1x 1.0 kW, gas consumption: 204 g/h, 30 mbar, dimensions: WxDxH 290x440x95 mm. Weight: 2.5 kg. Scope of delivery: Gas hob incl. installation accessories **70562 219,-**

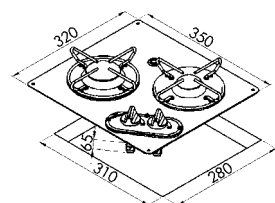

③ Built-in gas hob - 2-burner stainless steel

- 2 flame, with ignition fuse
- Stainless steel surface
- 1x 1,8 kW, 1x 1,0 kW

Control element at the bottom, 2-burner, manual ignition, power: 1x 1.8 kW, 1x 1.0 kW, gas consumption: 204 g/h, 30 mbar, Dimensions: WxDxH 350x320x65 mm. Installation dimensions: WxD 330x300 mm. Weight: 2.5 kg. Scope of delivery: Gas hob incl. installation accessories **70561 235,-**

SAFETY GLASS GAS HOBS

WITH
IGNITION-
FUZE

SAFETY
GLASS

30
mbar

CE

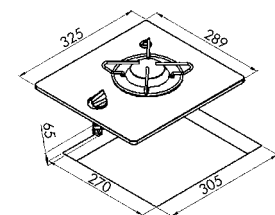

① Built-in gas hob - 1-burner glass

- 1 flame, with ignition fuse
- High quality safety glass
- 1x 1,8 kW

Safety glass, controls at the bottom, 1-burner, manual ignition, power: 1x 1.8 kW, gas consumption: 131 g/h, 30 mbar, installation dimensions: WxD 270x305 mm, dimensions: WxDxH 290x325x65 mm. Weight: 3,0kg. Scope of delivery: Gas hob incl. installation accessories **70557 209,-**

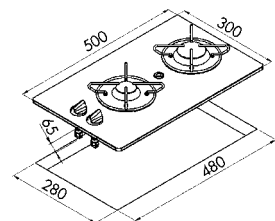

② Built-in gas hob - 2-burner glass

- 2 flame, with ignition fuse
- High quality safety glass
- 1x 1,8 kW, 1x 1,0 kW

Safety glass, controls at the bottom, 2-burner, manual ignition, output: 1x 1.8 kW, 1x 1.0 kW, gas consumption: 204 g/h, 30 mbar, dimensions: WxDxH 300x500x65 mm. Installation dimensions: WxD 280x480 mm. Weight: 4,3kg. Scope of delivery: Gas hob incl. installation accessories **70559 319,-**

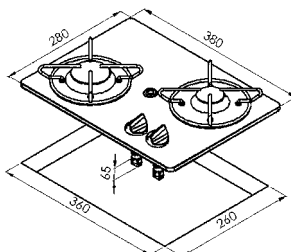

③ Built-in gas hob - 2-burner glass

- 2 flame, with ignition fuse
- High quality safety glass
- 1x 1,8 kW, 1x 1,0 kW

Safety glass, controls at the bottom, 2-burner, manual ignition, output: 1x 1.8 kW, 1x 1.0 kW, gas consumption: 204 g/h, 30 mbar, dimensions: WxDxH 380x280x65 mm. Installation dimensions: WxD 360x260 mm. Weight: 3,5kg. Scope of delivery: Gas hob incl. installation accessories **70558 279,-**

GAS HOBS WITH GLASS COVER

WITH
IGNITION-
FUZE

SAFETY
GLASS

STAINLESS
STEEL

30
mbar

CE

① Gas stove - 1 burner with glass cover

- 1 flame, with ignition fuse
- 1x 1,8 kW

Stainless steel, control element on the right, 1 flame, with manual ignition. Power: 1x 1.8 kW, gas consumption: 131 g/h, 30 mbar. Dimensions: WxDxH 357x250x119 mm. Installation dimensions: WxD 338x238 mm, weight: 3.0 kg. Scope of delivery: Gas hob incl. installation accessories. **70568 222,-**

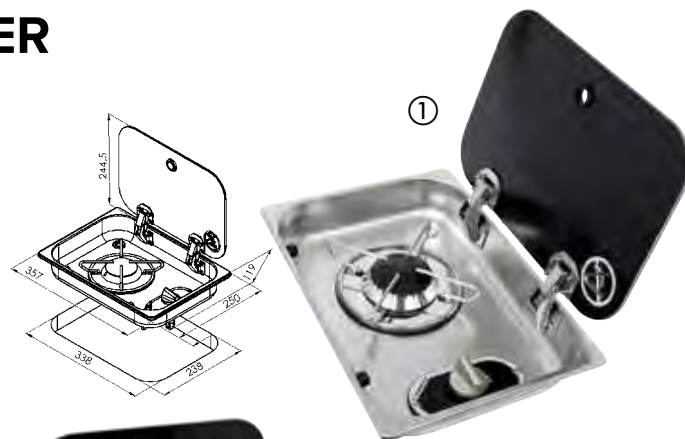

② Gas stove - 1 burner with glass cover

- 1 flame, with ignition fuse
- 1x 1,8 kW

Stainless steel, bottom control element, 1-burner, with manual ignition. Power: 1x 1.8 kW, gas consumption: 131 g/h, 30 mbar. Dimensions: WxDxH 322x352x119 mm. Installation dimensions: WxD 310x342 mm. Weight: 3,5kg. Can be combined with sink 70566. Scope of delivery: Gas stove incl. installation accessories. **70569 232,-**



② Can be combined with sink 70566 (page 50)

③ Gas stove - 2 flame with glass cover

- 2 flame, with ignition fuse
- 1x 1,8 kW, 1x 1,0 kW

Stainless steel, control element at the bottom, 2 flame, with manual ignition. Power: 1x 1.8 kW, 1x 1.0 kW, gas consumption: 204 g/h, 30 mbar. Dimensions: WxDxH 530x326x119 mm. Installation dimensions: WxD 505x305 mm. Weight: 5,5kg. Scope of delivery: Gas stove incl. installation accessories. **70567 259,-**

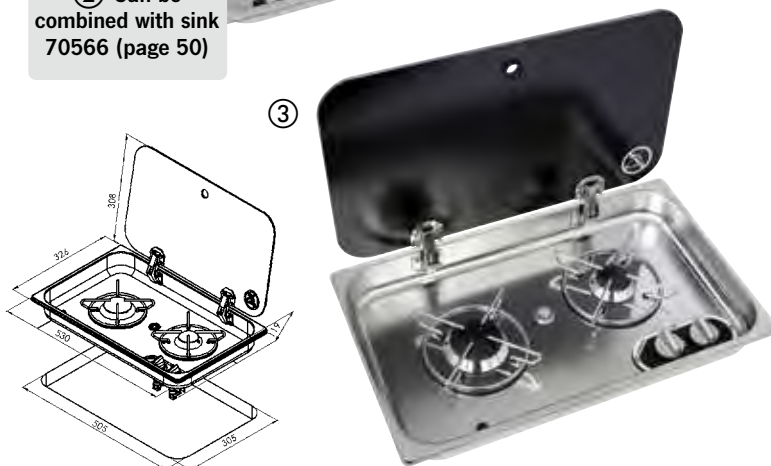

① Gas stove - 2 flame with glass cover

- Burner power: 1x 1.8 kW, 1x 1.0 kW, gas consumption 204 g/h
- Dimensions: WxDxH 470x370x125 mm, installation dimensions: WxD 450x358 mm. Weight: 4 kg. Scope of delivery: gas stove with glass cover, rubber seals and mounting accessories. **70142 299,-**

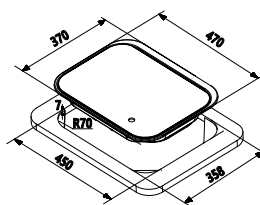

② Gas stove - 3 flame with glass cover

- Burner power: 2x 1.8 kW, 1x 1.0 kW, gas consumption 305 g/h
- Dimensions: WxDxH 570x450x115 mm, installation dimensions: WxD 554x438 mm. Weight: 6 kg. Scope of delivery: gas stove with glass cover, rubber seals and mounting accessories. **70143 369,-**

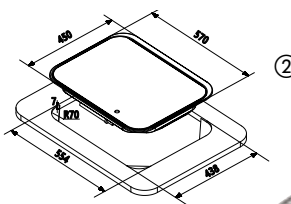

③ Cover cap, 8 pieces

Suitable for the following CARBEST cookers/sinks: 70142/70143/70144/70176/70177

and all standard hob/sinks with 8 mm hole. Material: rubber, colour black. **70149 7,95**

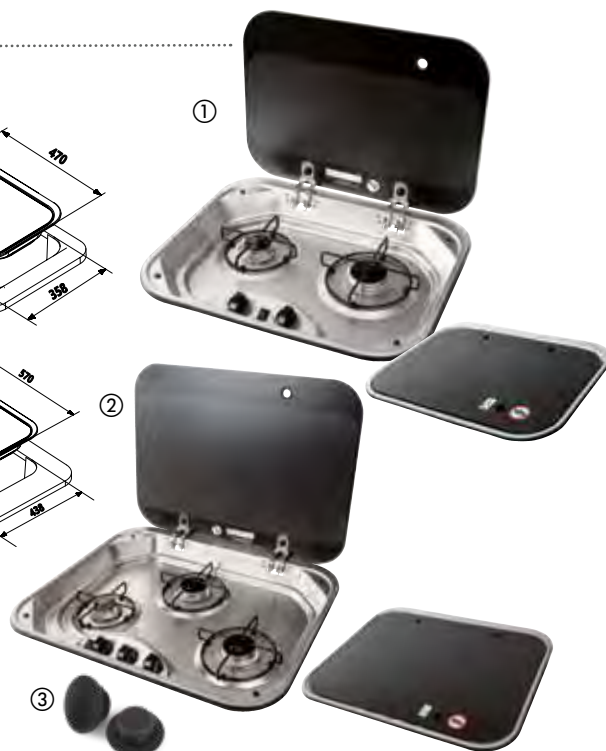

GAS HOB / SINK COMBINATIONS



NEW
2024



Optimal water drainage,
thanks to sloped design

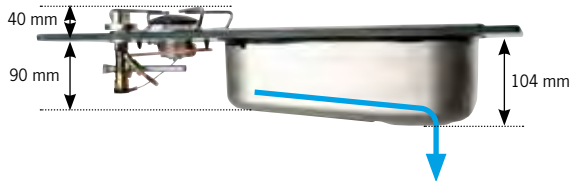

Stove/sink combination - Vanstream 1 burner with safety glass

- With built-in Vanstream sink
- Optimum water drainage thanks to sloped design
- Ideal for campervans and vans
- 1-burner (1.8 kW) with ignition fuse
- High-quality 8 mm safety glass

Control element at the bottom, matt stainless steel sink on the right. Power: 1.8 kW, gas pressure: 30 mbar, gas consumption: 131 g/h, ignition: Manual, with safety pilot. Dimensions: WxDxH 550x334x90/104 mm, installation dimensions: WxD 520x280 mm. Weight: 3.5 kg, colour: black, material: safety glass. Scope of delivery: Hob/sink combination. Please order drain set type E separately (e.g. 705065).

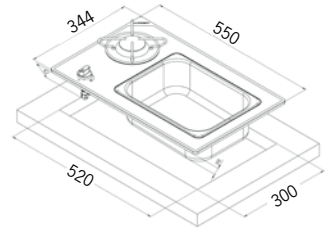

70575 369,-

NEW
2024



Hob/sink combination - 1 burner with safety glass

- 1-burner (1.8 kW) with ignition fuse
- High-quality 8 mm safety glass

Control element at the bottom, matt stainless steel sink on the right. Power: 1.8 kW, gas pressure: 30 mbar, gas consumption: 131 g/h, ignition: Manual, with safety pilot. Dimensions: WxDxH 550x334x136 mm, installation dimensions: WxD 520x280 mm. Weight: 3.5 kg, colour: black, material: safety glass. Scope of delivery: Hob/sink combination. Please order drain set type E separately (e.g. 705065).

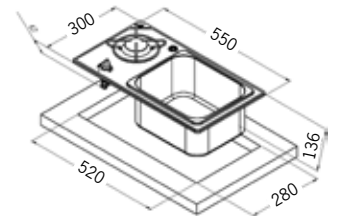

70179 349,-

NEW
2024



Hob/sink combination - 2 burners with safety glass

- 2-burner (1x 1.8 kW, 1x 1.0 kW) with ignition fuse
- High-quality 8 mm safety glass

Controls at the bottom, stainless steel sink matt right. Power: 1x 1.8 kW, 1x 1.0 kW Gas pressure: 30 mbar, gas consumption 204g/h, ignition: Manual, with safety pilot, dimensions: WxDxH 765x334x136 mm, installation dimensions: WxD 735x280 mm. Weight: 5kg, colour: black, material: safety glass. Scope of delivery: Hob/sink combination. Please order drain set type E separately (e.g. 705065).

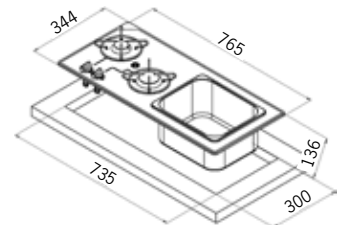

70180 399,-

NEW
2024



Hob/sink combination - 2 burners with safety glass

- 2-burner (1x 1.8 kW, 1x 1.0 kW) with ignition fuse
- High-quality 8 mm safety glass

Controls at the bottom, stainless steel sink glossy left. Power: 1x 1.8 kW, 1x 1.0 kW, gas pressure: 30 mbar, gas consumption 204g/h, ignition: Manual, with safety pilot, dimensions: WxDxH 600x420x65 mm, installation dimensions: WxD 590x400 mm. Weight: 6.3kg, colour: black, material: safety glass. Scope of delivery: Hob/sink combination. Please order drain set type E separately (e.g. 705065).

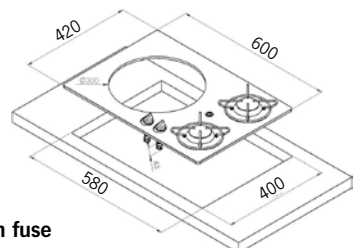

70178 399,-

GAS HOB / SINK COMBINATIONS WITH GLASS COVERS



Hob and sink combination - single burner with glass cover

- 1-burner (1.8 kW) with ignition fuse
- Piezo ignition
- With glass cover

Made of polished stainless steel, with glass cover, controls at the bottom, sink on the right, power: 1.8 kW, gas pressure: 30 mbar, gas consumption 131 g/h, piezo ignition, with safety fuse, dimensions: WxDxH 526x326x163 mm, installation dimensions: WxD 508x305 mm, Water tap hole: Ø 33.5 mm.

Weight: 7kg, colour: black/silver, material: stainless steel. Scope of delivery: Hob/sink combination. Please order drain set type E separately(e.g. 705065).

70181 329,-

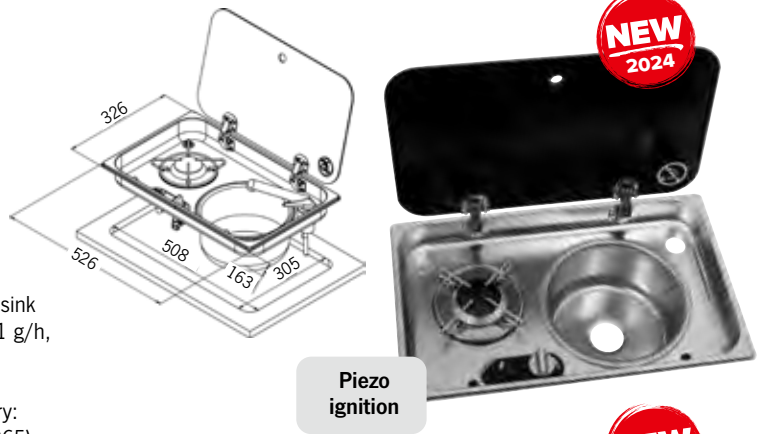

Hob and sink combination - single burner with glass cover

- 1-burner (1.8 kW) with ignition fuse
- Piezo ignition
- with glass cover

Made of polished stainless steel, with glass cover, controls at the bottom, sink on the left, power: 1.8 kW, gas pressure: 30 mbar, gas consumption 131 g/h, piezo ignition, with safety fuse. Dimensions: WxDxH 526x326x163 mm, installation dimensions: WxD 508x305 mm, Water tap hole: Ø 33.5 mm. Weight: 7kg, colour: black/silver, material: stainless steel. Scope of delivery: Hob/sink combination. Please order drain set type E separately (e.g. 705065).

70183 329,-

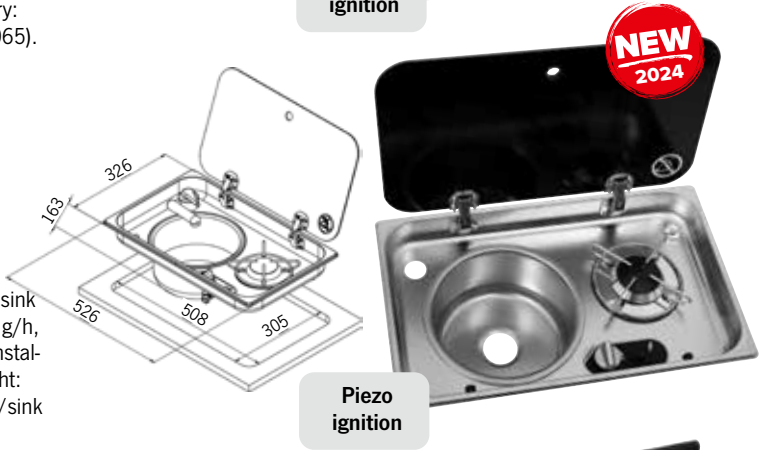

Hob/sink combination with 2-piece glass cover

- 2-burner(1x 1.8 kW, 1x 1.0 kW) with ignition fuse
- Piezo ignition
- with glass cover

Made of polished stainless steel, with glass cover, controls at the bottom, sink on the right, power: 1x 1.8 kW, 1x 1.0 kW, gas pressure: 30mbar, gas consumption 204g/h, piezo ignition, with ignition fuse. Dimensions: WxDxH 900x360x190 mm, Installation dimensions: WxD 885x315 mm. Water tap hole: Ø 39 mm. Weight: 7 kg. Outer diameter of the siphon hose connection: approx. 20mm.

Scope of delivery: Hob/sink combination with glass cover, drain set, rubber seals and installation accessories.

70176 369,-

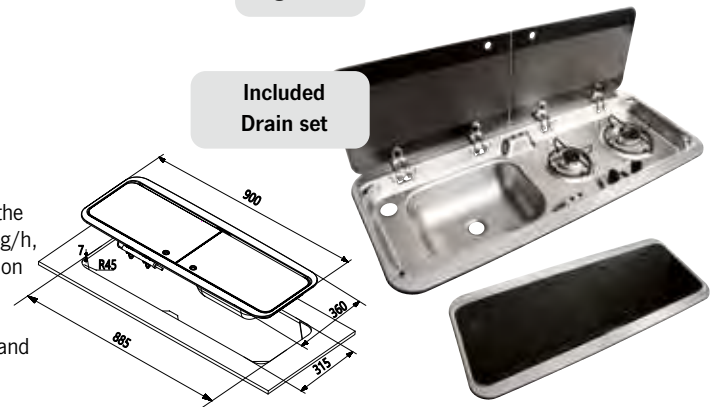

STAINLESS STEEL SINKS WITH GLASS COVERS

- Easy to clean
- Including glass cover
- High quality design

Stainless steel sink with glass cover.

Dimensions: WxDxH 415x365x156 mm, installation dimensions: WxD 398x325 mm. Tap Ø: approx. 35mm. Ø drain: approx. 41 mm. Ø hose connection: approx. 20 mm Weight: 2.8 kg.

Scope of delivery: sink, drain set, plug, manual instructions.

70144 189,-

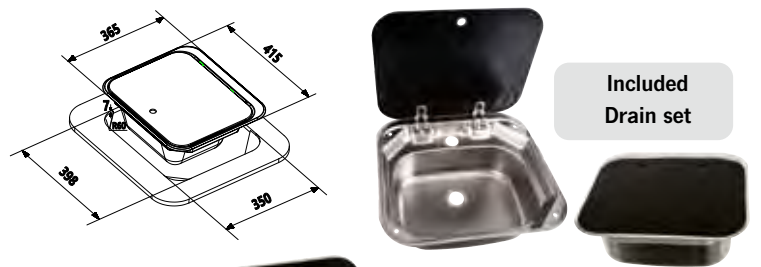

Sink including tap and glass cover

- Easy to clean
- Including tap and glass cover
- High quality design

Stainless steel sink, with glass cover and tap. Can be combined with stove 70569. Dimensions: WxDxH 322x352x150 mm, installation dimensions: WxD 310x342 mm. Scope of delivery: sink and tap.

Please order drain set type E separately(e.g. 705065).

70566 249,-

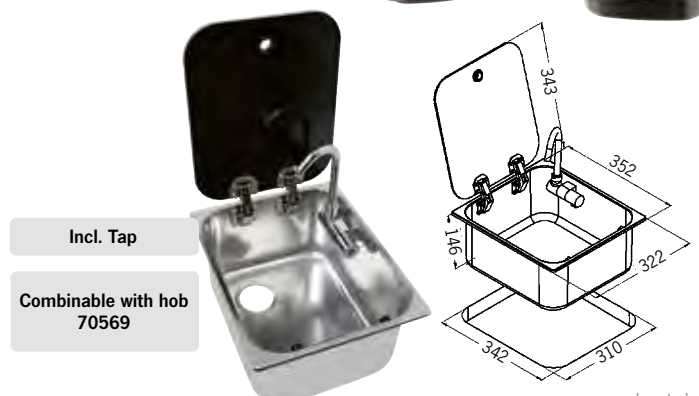



STAINLESS STEEL SINKS

VanStream stainless steel sink

- Sloped design for optimal water drainage
- Compact dimensions
- Ideal for campervans and vans
- Matt stainless steel

Stainless steel sink with sloped design for optimal water drainage even when the vehicle is on an incline. Dimensions:

WxDxH 325x245x104/117 mm Installation dimensions:

WxD 298x218 mm. Please order drain set type E separately (e.g. 705065). **70573 119,-**

Optimal water drainage, thanks to sloped design

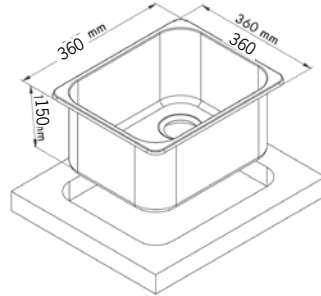
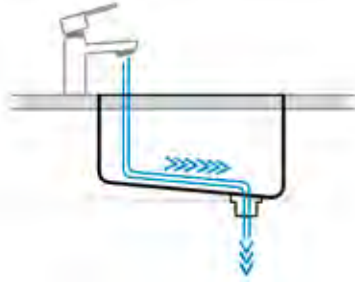

Square sink

- Easy to clean
- Matt stainless steel

Dimensions: WxDxH 360x360x150 mm Installation dimensions:

WxDxH 336x336x150 mm

Please order drain set type E separately (e.g. 705065).

70117 89,90

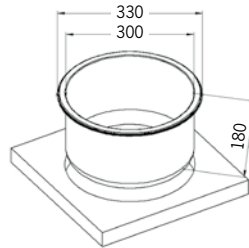

Cylindrical sink

- Easy to clean
- Elegant look
- High-gloss stainless steel

Dimensions: Ø 330 mm, H 180 mm Installation dimension: Ø 300 mm

Weight: 1,4 kg. Please order drain set type E separately (e.g. 705065).

70565 91,95

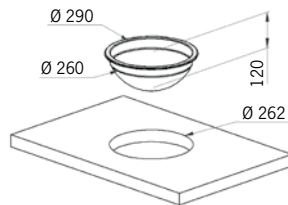

Round sink (Ø 290 mm)

- Easy to clean
- High-gloss stainless steel

Dimensions: Ø 290 x H 120 mm

Installation dimension: Ø 300 mm

Weight: 0,8kg. Please order drain set type E separately (e.g. 705065).

70564 59,95

STAINLESS STEEL SINK



① Ø 265 mm

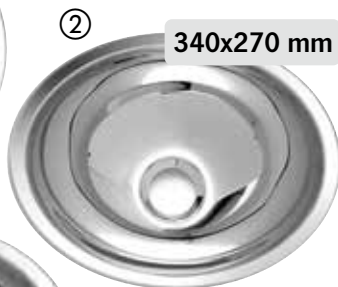

② 340x270 mm



③ 432x305 mm

① Round Ø 265 mm

- Easy to clean
- High-gloss stainless steel

Dimensions: Ø 265 mm, H 120 mm

Installation dimensions: Ø 225 mm

Please order drain set type E separately (e.g. 705065).

64031 38,95

② Oval 340x270 mm

- Easy to clean
- High-gloss stainless steel

Dimensions: WxDxH 340x270x120 mm

Installation dimensions: WxD 280x210 mm

Please order drain set type A (Ø 37 mm) / type F (Ø 35 mm) separately.

64032 40,95

③ Oval 432x305 mm

- Easy to clean
- High-gloss stainless steel

Dimensions: WxDxH 432x305x130 mm

Installation dimension: WxD 375x245 mm

Please order drain set type A (Ø 37 mm) / type F (Ø 35 mm) separately.

64033 49,95

PRESSURIZED WATER PUMPS / SUBMERSIBLE PUMPS

① 2-chamber pressure water pump

3.8 l/min, 2.8 bar

Self-priming. Connection via 3/8" hose nozzle, for 10 mm fresh water hose. 12 V, 3.5 A (max. 7.5 A). Dimensions: LxWxH 154x98x62 mm.

620550 39,90



② 3-chamber pressurized water pump

7 l/min, 1.4 bar

Self-priming. Connection via 1/2" external thread. Incl. Filter and 2 hose adapters, for 10 mm fresh water hose. 12 V, 3.0 A (max. 6.0 A). Dimensions: LxWxH 203x130x123 mm.

62055 89,90



③ 3-chamber pressure water pump

10 l/min, 2.8 bar

Self-priming. Connection via 1/2" external thread. Incl. Filter and 2 hose adapters, for 10 mm fresh water hose. 12 V, 3.5 A (max. 8.5 A). Dimensions: LxWxH 203x130x123 mm.

62056 89,90

④ 4-chamber pressurized water pump

11.3 l/min, 3.8 bar

Self-priming. Connection via 1/2" external thread. Incl. Filter and 2 hose adapters, for 10 mm fresh water hose. 12 V, 3.5 A (max. 8.5 A). Dimensions: LxWxH 203x130x111 mm.

620560 99,90



⑤ 5-chamber pressurized water pump

18.9 l/min, 4.2 bar

Self-priming. Connection via 1/2" external thread. Incl. Filter and 2 hose adapters, for 10 mm fresh water hose. 12 V, 7.5 A (max. 17 A). Dimensions: LxWxH 203x130x111 mm.

620561 139,-



Submersible pumps

- Pipe socket connection for hoses with Ø 10-12 mm
- Connection with hose clamp to any hose with suitable diameter possible
- Suitable for short dry run
- Small diameter - Suitable for small canister openings

⑥ **Submersible pump 10 l** 10 liters/min, 1.5 bar, 40 W, Ø pump approx. 38 mm, weight 140g.

62130 16,95

⑦ **Submersible pump 15 l** 15 liters/min, 1.5 bar, 50 W, Ø pump approx. 49 mm, weight 168g.

62131 17,95

⑧ Submersible pump 16 l

- Fully immersible
- Low-noise and low-vibration operation
- Permanently lubricated

12 V, 0.6 bar, 5.0 A, operating time for 30 min, delivery head up to 6 m, dry seal with permanent lubrication, hose connection: Ø 12 mm / 1/2", weight: 0.24 kg, dimensions: HxW 106x48 mm.

620001 11,95



PIPE SYSTEM FOR FRESH WATER

Pluggable fresh water pipe system 12 mm

- Clean installation with optimum protection
- 100 % leak-proof up to a pressure of 12 bar at 23° C
- Push-fit system for quick installation
- The connections are detachable and reusable
- All parts are food-safe
- Polyethylene water pipe, outer Ø 12 mm
- All connectors with safety clips to prevent accidental loosening
- No more complicated handling of hose clamps



					
Connector 1/2" IT Ø 12 650011 4,95	Connector 3/8" IT Ø 12 650012 4,95	Connector 1/2" AG Ø 12 650013 4,95	Connector 3/8" AG Ø 12 650014 4,95	Angle connector to 1/2" union nut Ø 12 650015 5,70	Y-connector Ø 12 650017 6,70
					
T-connector Ø 12 650018 7,49	Connector straight Ø 12 650019 4,95	Adapter to 10 mm pipe Ø 12 650020 7,50	Angle connector Ø 12 650021 5,20	Angle connector one-sided 12 mm tube. Ø 12 650022 3,95	Safety clip 10 pcs 650025 4,90
					
Angle adapter from 12 mm tube to 12 mm hose nozzle 650026 2,95	Adapter straight from 12 mm tube to 12 mm hose nozzle 650027 2,60	Push-in tube connector 12 mm tube 650028 2,60	Adapter straight from 12 mm tube to 10 mm hose nozzle 650029 1,70		
					
Shut off valve short Ø 12 650024 9,99	Shut off valve long with tap extension app. 215 mm Ø 12 650030 12,-		Cold water pipe up to 12 bar. Bending radius max 85 mm. 5 m Ø 12 6500310 7,95	Hot water pipe up to 12 bar. Bending radius max 85 mm. 5 m Ø 12 6500320 7,95	



YOUR ONE STOP SHOP FOR CAMPER,
MOTORHOMES, CARAVANS. SINCE 1980.

DOWNLOAD OUR CATALOGUES.

Scan the QR code and view or download catalogues on your smartphone/tablet.
Alternatively, you can find all catalogs in the download area on our website:
www.reimo.com/download-catalogues

Scan QR code - here's how:

1. Open your camera app on your smartphone/tablet.
2. Point the camera steadily at the QR code for 2-3 seconds.
3. Tap on the link displayed to access the catalogue.



REIMO ACCESSORIES PRO



- ✓ More than 12.500 camping products
- ✓ More than 1.000 pages
- ✓ 1.200 new products



REIMO VAN CONVERSION



- ✓ Individual camper van equipment
- ✓ Vacation-ready vans, minivans and maxivans
- ✓ Rock'n'roll beds, pop-top roofs, self-conversion modules and conversion materials



REIMO TENT TECHNOLOGY



- ✓ The entire Reimo tent range
- ✓ Huge selection of caravan, motorhome & camper van tents and awnings
- ✓ Including matching accessories



HOLIDAY TRAVEL



- ✓ Exclusive camping articles for true vanlife fans
- ✓ Selected, designed and recommended by real campers
- ✓ Stylish products made from high-quality materials



MC CAMPING



- ✓ Camping accessories for price conscious
- ✓ Great value for money
- ✓ Selected product range of camping furniture and electronic items

www.reimo.com

TINTED SAFETY GLASS WINDOWS



SAFETY GLASS

LIGHT TRANSMISSION: 18%

E
ECE R43

Safety glass windows for Volkswagen Caddy



Rear windows without wiper holes

VW Caddy Maxi > 2021 Ford Tourneo Connect from YOC. 2022			Sliding window		
Installation position	Wheelbase	Outer dims. W x H (mm)	Weight (kg)	Item no.	Price
	long	970x493	6,0	316027	199,-
	long	970x493	6,0	316026	199,-

VW Caddy Maxi 2008-2020			Rigid windows			Sliding window		
Installation position	Wheelbase	Outer dims. W x H (mm)	Weight (kg)	Item no.	Price	Weight (kg)	Item no.	Price
	long	714x538	3,7	316021	88,50	4,7	31618	228,-
	long	714x538	3,7	316020	88,50	4,7	31617	229,-
	long	1044x545	5,5	31605	119,-	—	—	—
	long	1044x545	5,5	31604	119,-	—	—	—
	long	591x504	3,0	316023	160,65	—	—	—
	long	750x596	4,3	316022	160,65	—	—	—

VW Caddy/Maxi 2015-2020			Rear window		
Installation position	Wheelbase	Outer dims. W x H (mm)	Weight (kg)	Item no.	Price
	SWB + LWB	1377x588	9,0	316025	194,65

VW Caddy/Maxi 2004-2016			Rear window		
Installation position	Wheelbase	Outer dims. W x H (mm)	Weight (kg)	Item no.	Price
	SWB + LWB	1257x591	9,0	316024	186,15

Safety glass windows for Citroën Jumpy 3 / Spacetourer Peugeot Expert 3 / Traveller Toyota Proace 2 / Proace Verso Opel Vivaro / Zafira Life (> 2017) Fiat Scudo / Ulysse (> 2022)



SAFETY GLASS

LIGHT-THROUGH-TRANSMISSION: 18%

E
ECE R43



			Rigid windows			Sliding window		
Installation position	Wheelbase	Outer dims. W x H (mm)	Weight (kg)	Item no.	Price	Weight (kg)	Item no.	Price
	SWB + LWB	1100x541	—	—	—	7,0	31701	247,-
	SWB + LWB	1100x541	—	—	—	7,0	31700	246,-
	SWB	851x534	—	31708	99,-	—	—	—
	SWB	851x534	—	31709	99,-	—	—	—
	long	1175x534	6,0	31705	129,-	7,5	31703	299,-
	long	1175x534	6,0	31704	129,-	7,5	31702	299,-
	SWB + LWB	675x495	3,5	31707	189,-	—	—	—
	SWB + LWB	735x495	3,5	31706	189,-	—	—	—

For the installation of safety glass windows we recommend:

① Activator 205, for cleaning the adhesive surface

Solvent-based, colourless adhesive cleaner for cleaning adhesive surfaces in combination with Sika adhesives/sealants. 30 ml GP 43.17/100 ml
294100 12,95
 Hazard: H225, H319, H336

② SikaTack DRIVE adhesive set, for bonding the window

Pane adhesive set for bonding safety glass panes. 1-2 sets are needed for the installation of a vehicle window. Set contents: 1x SikaTack DRIVE Purform (300 ml cartridge), 1x SikaPrimer-507 (30ml), 2x Sika Cleaner Pad, 1x applicator nozzle.
 Danger: H334
294842 42,90

③ Edge cover profile

Cutting out the sheet metal often results in an unsightly cut edge. This can be concealed with the edge protection profile. Please check during installation whether the pane can still be glued in correctly.

Small clamping range: 0.5-1.5 mm

5 m, black 294559 14,90 GP* 2,98/ 1m
10 m, black 294551 29,90 GP* 2,99/ 1 m

Large clamping range: 1.5-4.0 mm

10 m, black 294560 79,90 GP* 7,99/ 1 m

The bonding surfaces must be stable to take a load and free of dust, adhesive and grease-free.



TINTED SAFETY GLASS WINDOWS

Safety glass hinged windows for Volkswagen T6.1 / T6 / T5



SAFETY GLASS

LIGHT-THROUGH-TRANSMISSION: 18%



2 STEP-LESS EXHIBITORS

MIT 2 LOCKING BOLTS

WITH VENTILATION POSITION



(E)
ECE R43

Volkswagen T6.1 / T6 / T5 > 2004

Installation position	Wheelbase	Outer dims. W x H (mm)	Review W x H (mm)	Hinged windows 		
				Weight (kg)	Item no.	Price
	SWB + LWB	1135x585	730x360	12,0	315916	505,-
	SWB + LWB	1135x585	730x360	12,0	315915	505,-



Optional Blackout system

	External dimensions (mm)	842x492	Item no. 3181008	Price 119,-
	External dimensions (mm)	830x440	Item no. 3181012	Price 99,-



NEW 2024
Black matt

OPTIONAL

Blackout system w/ privacy & mosquito protection- Pleated blind w/ magnetic closure. **NEW:** With matt black frame and black pleated blinds in a very high-quality look.

Hinged windows for Ford Custom available from fall 2024.

A suitable substructure must be created before installing the blackout system!

Safety glass windows for Volkswagen T6.1 / T6 / T5 / T4



SAFETY GLASS

LIGHT-THROUGH-TRANSMISSION: 18%







(E)
ECE R43

VW T6.1/T6/T5 > 2004

Installation position	Wheelbase	Outer dims. W x H (mm)	Rigid windows 			Sliding window 		
			Weight (kg)	Item no.	Price	Weight (kg)	Item no.	Price
	SWB + LWB	1135x585	6,5	315910	104,-	8,0	31591	207,-
	SWB + LWB	1135x585				8,0	31590	207,-
	SWB	922x572	5,0	31599	94,-	6,5	315911	208,-
	SWB	922x572	5,0	31598	94,-	6,5	315900	208,-
	long	1257x570	6,8	315990	104,-	8,3	315912	208,-
	long	1257x570	6,8	315980	104,-	8,3	315901	208,-
	SWB + LWB	729x579	4,0	316004	108,-			
	SWB + LWB	729x579	4,0	316003	108,-			





VW T4 1990-2004



Installation position	Wheelbase	Outer dims. W x H (mm)	Rigid windows 			Sliding window 		
			Weight (kg)	Item no.	Price	Weight (kg)	Item no.	Price
	SWB + LWB	1126x523				7,5	31503	223,-
	SWB + LWB	1126x523				7,5	31504	223,-
	SWB	967x522	5,0	31505	102,-			
	SWB	967x522	5,0	31506	102,-			



VW T6.1/T6 > 2016

Installation position	Wheelbase	Outer dims. W x H (mm)	Rear window 		
			Weight (kg)	Item no.	Price
	SWB + LWB	1544x562	8,0	31600	224,-

VW T5 2004-2016

Installation position	Wheelbase	Outer dims. W x H (mm)	Rear window 		
			Weight (kg)	Item no.	Price
	SWB + LWB	1445x575	8,0	316005	199,-



Rear windows without wiper holes

TINTED SAFETY GLASS WINDOWS

Safety glass windows for Mercedes-Benz Vito



SAFETY GLASS

LIGHT-THROUGH-TRANSMISSION: 18%

E
ECE R43



Mercedes-Benz Vito 2004-2014			Rigid windows			Sliding window		
Installation position	Wheelbase	Outer dims. W x H (mm)	Weight (kg)	Item no.	Price	Weight (kg)	Item no.	Price
	SWB/MWB/LWB	1096x565	6,0	31511	119,-	7,5	31521	219,-
	SWB/MWB/LWB	1096x565	6,0	31510	119,-	7,5	31520	219,-
	SWB	1169x521	7,5	31523	107,-	—	—	—
	SWB	1169x521	7,5	31522	107,-	—	—	—
	long	1296x521	6,5	31513	119,-	—	—	—
	long	1296x521	6,5	31512	119,-	—	—	—



Mercedes-Benz Vito > 2015			Rigid windows			Sliding window		
Installation position	Wheelbase	Outer dims. W x H (mm)	Weight (kg)	Item no.	Price	Weight (kg)	Item no.	Price
	SWB/MWB/LWB	1100x570	6,0	315962	109,-	7,5	31597	219,-
	SWB/MWB/LWB	1100x570	6,0	315961	109,-	7,5	31596	219,-
	medium	1195x531	6,0	315970	109,-	—	—	—
	medium	1195x531	6,0	315960	109,-	—	—	—
	long	1300x529	6,6	315966	109,-	8,1	315964	253,-
	long	1300x529	6,6	315965	109,-	8,1	315963	253,-



SAFETY GLASS

LIGHT-THROUGH-TRANSMISSION: 18%

E
ECE R43

Safety glass window for Renault Traffic / Nissan NV300 / Nissan Primastar / Ford Transit Custom



Renault Traffic 2002-2015			Rigid windows			Sliding window		
Installation position	Wheelbase	Outer dims. W x H (mm)	Weight (kg)	Item no.	Price	Weight (kg)	Item no.	Price
	SWB + LWB	1193x665	—	—	—	9,0	316012	247,-
**	SWB + LWB	1193x665	—	—	—	9,0	316011	247,-
	SWB + LWB	670x623	4,0	315914	113,-	—	—	—
	SWB + LWB	670x623	4,0	315913	113,-	—	—	—



Renault Traffic/Nissan NV300 > 2015 Nissan Primastar > 2022			Rigid windows			Sliding window		
Installation position	Wheelbase	Outer dims. W x H (mm)	Weight (kg)	Item no.	Price	Weight (kg)	Item no.	Price
	SWB + LWB	1116x598	6,5	316010	109,-	9,0	31593	212,-
	SWB + LWB	1116x598	—	—	—	9,0	31592	212,-
	SWB	919x571	5,0	31602	99,-	—	—	—
	SWB	919x571	5,0	31601	99,-	—	—	—
	long	1319x579	7,5	316014	113,-	—	—	—
	long	1319x579	7,5	316013	113,-	—	—	—
	SWB + LWB	670x623	4,0	315914	113,-	—	—	—
	SWB + LWB	670x623	4,0	315913	113,-	—	—	—















Ford Transit Custom 7/2013-2022			Rigid windows			Sliding window		
Installation position	Wheelbase	Outer dims. W x H (mm)	Weight (kg)	Item no.	Price	Weight (kg)	Item no.	Price
	SWB + LWB	1199x566	—	—	—	8,0	31595	362,-
**	SWB + LWB	1208x566	—	—	—	8,0	31594	362,-

Safety glass window for Ford Custom from 2024 in preparation.

ATTENTION: **Does not fit vehicles with left-hand sliding door.









TINTED SAFETY GLASS WINDOWS

F. Ducato/P. Boxer/C. Jumper > 2007 O. Movano > 2021			Rigid windows 			Sliding window 		
Installation position	Vehicle lengths (mm)	Outer dims. W x H (mm)	Weight (kg)	Item no.	Price	Weight (kg)	Item no.	Price
	5413/5998/6363	1400x665	9,0	316190	159,-	10,5	31619	257,-
	5413/5998/6363	1434x665	9,0	316200	159,-	10,5	31620	257,-
	5998/6363	1360x585	8,5	316220	159,-	9,5	31622	243,-
	5998/6363	1360x585	8,5	316210	159,-	9,5	31621	251,-
	6363	1128x665	7,3	316230	149,-	8,5	31623	244,-
	6363	1128x665	7,3	316240	149,-	8,5	31624	244,-
	4963/5413/5998/6363	826x665	5,3	31625	98,-	—	—	—
	4963/5413/5998/6363	826x665	5,3	31626	98,-	—	—	—
	270° 4963/5413/5998/6363 (For 270° door hinges)	826x670	5,3	31627	108,-	—	—	—
	270° 4963/5413/5998/6363 (For 270° door hinges)	826x670	5,3	31628	108,-	—	—	—

SAFETY GLASS  LIGHT-THROUGH-TRANSMISSION: 18%  **E** ECE R43













**Fiat Ducato Citroën
Jumper Opel Movano**

Mercedes-Benz Sprinter > 2007			Rigid windows 			Sliding window 		
Installation position	Vehicle lengths (mm)	Outer dims. W x H (mm)	Weight (kg)	Item no.	Price	Weight (kg)	Item no.	Price
	5910/6945/7345	1405x766	—	—	—	12,0	315002	326,-
	5910/6945/7345	1408x766	—	—	—	12,0	315003	326,-
	6945/7345	1416x706	10,5	315001	169,-	—	—	—
	6945/7345	1422x766	10,5	315000	169,-	—	—	—
Mercedes-Benz Sprinter 2007-2018			—	—	—	—	—	—
	5910/6945/7345	818x800	6,3	315004	179,-	—	—	—
	5910/6945/7345	818x800	6,3	315005	179,-	—	—	—













**Mercedes-Benz
Sprinter**









Mercedes-Benz Sprinter > 2019			Rigid windows 		
Installation position	Vehicle lengths (mm)	Outer dims. W x H (mm)	Weight (kg)	Item no.	Price
	5932/6977/7367	775x775	6,0	315006	193,-
	5932/6977/7367	775x775	6,0	315007	193,-

Volkswagen Crafter 2007-2016			Rigid windows 			Sliding window 		
Installation position	Vehicle lengths (mm)	Outer dims. W x H (mm)	Weight (kg)	Item no.	Price	Weight (kg)	Item no.	Price
	5910/6945/7345	1405x766	—	—	—	12,0	315002	326,-
	5910/6945/7345	1408x766	—	—	—	12,0	315003	326,-
	6945/7345	1416x706	10,5	315001	169,-	—	—	—
	6945/7345	1422x766	10,5	315000	169,-	—	—	—
	5910/6945/7345	818x800	6,3	315004	179,-	—	—	—
	5910/6945/7345	818x800	6,3	315005	179,-	—	—	—



Volkswagen Crafter

Volkswagen Crafter > 2017			Rigid windows 			Sliding window 		
Installation position	Vehicle lengths (mm)	Outer dims. W x H (mm)	Weight (kg)	Item no.	Price	Weight (kg)	Item no.	Price
	5986/6836/7391	1488x713	—	—	—	11,5	31710	369,-
	5986/6836/7391	1492x713	—	—	—	11,5	31711	369,-
	6836/7391	1455x637	—	—	—	11,0	31712	369,-
	6836/7391	1455x702	—	—	—	11,5	31713	369,-
	6836/7391	883x682	—	—	—	7,5	31714	349,-
	6836/7391	883x682	—	—	—	7,5	31715	349,-
	5986/6836/7391	776x649	5,0	31716	155,-	—	—	—
	5986/6836/7391	776x649	5,0	31717	155,-	—	—	—

Ford Transit V 363 > 2014			Rigid windows 			Sliding window 		
Installation position	Vehicle lengths (mm)	Outer dims. W x H (mm)	Weight (kg)	Item no.	Price	Weight (kg)	Item no.	Price
	5531/5981/6704	1369x754	—	—	—	11,0	31730	349,-
	5531/5981/6704	1369x754	—	—	—	11,0	31731	349,-
	5981/6704	972x723	8,0	31732	174,25	—	—	—
	5981/6704	977x729	8,0	31733	174,25	—	—	—
	5981	672x718	5,5	31734	157,25	—	—	—
	5981	672x718	5,5	31735	157,25	—	—	—



Ford Transit V 363

ATTENTION: **Does not fit vehicles with left-hand sliding door.

TINTED SAFETY GLASS WINDOWS RW ECO



Black matt

OPTIONAL

Blackout system w/ privacy & mosquito protection Pleated blind w/ magnetic closure. NEW: With matt black frame and black pleated blinds in a very high-quality look.

Tinted security glass windows RW Eco

SAFETY GLASS | **LIGHT-THROUGH-TRANSMISSION: 20%** | **WITH VENTILATION-POSITION** | **MATERIAL FRAME: ALUMINIUM** | **FOR WALL-THICKNESS FROM 30-32 mm** | **CORNER RADIUS WINDOW-FRAME: 75 mm** | **ECE R43**

Detail W x H (mm)	Outer dims. W x H (mm)	Review W x H (mm) app.	Max. Opening	kg	Item no.	Price
350x500	397x554	245x435	54°	2,8	31880	138,-
500x300	547x354	395x250	26°	2,6	31881	131,-
500x350	547x404	395x300	25°	2,8	31889	134,-
500x450	547x504	395x400	45°	3,3	31882	161,-
600x450	647x504	495x400	45°	4,5	31870	174,-
700x300	747x354	595x250	26°	3,4	31883	160,-
700 x 400	747x454	595x350	38°	4,5	31871	182,-
700 x 450	747x504	595x400	45°	4,7	31872	189,-
800 x 450	847x504	695x400	45°	5,2	31884	238,-
900 x 450	947x504	795x400	45°	5,6	31885	241,-
900 x 500	947x554	795x450	54°	6,3	31886	242,-
1000x500	1047x554	895x450	54°	6,8	31887	254,-

RW Eco blackout system

OPTIONALLY AVAILABLE | **DARKENING PLISSEE** | **MOSKITO-PROTECTION PLISSEE** | **MATERIAL FRAME: ALUMINIUM**

Outer dim. W x H (mm)	Item no.	Price	Item no.	Price
381x546	318801	93,-	318802	93,-
531x346	318811	91,-	318812	91,-
531x396	318891	89,-	318892	89,-
531x496	318821	96,-	318822	96,-
631x496	318701	97,-	318702	97,-
731x346	318831	105,-	318832	105,-
731x446	318711	102,-	318712	102,-
731x496	318721	106,-	318722	106,-
831x496	318841	119,90	318842	119,90
931x496	318851	123,-	318852	123,-
931x546	318861	127,-	318862	127,-
1031x546	318871	133,-	318872	133,-

TINTED SAFETY GLASS WINDOWS RW MOTION



OPTIONALLY

Blackout system with privacy and Mosquito protection pleated blind with magnetic closure

Tinted security glass windows RW Motion

SAFETY GLASS | **DOUBLE GLAZED** | **LIGHT-THROUGH-TRANSMISSION: 20%** | **LEFT AND RIGHT MOUNTABLE** | **MATERIAL FRAME: ALUMINIUM** | **FOR WALL-THICKNESS FROM 30 mm** | **CORNER RADIUS WINDOW-FRAME: 87 mm** | **ECE R43**

Detail W x H (mm)	Outer dims. W x H (mm)	Viewing approx. W x H (mm)	Weight (kg)	Item no.	Price
500x300	528x328	380x225	4,8	31657	148,-
500x350	528x378	380x275	6,5	31650	172,-
500x450	528x478	380x375	6,6	31654	199,-
600x350	628x378	480x275	6,2	31653	182,-
600x450	628x478	480x375	7,7	31658	193,-
700 x 300	728x328	580x225	6,4	31659	187,-
700 x 400	728x428	580x325	8,0	31660	211,-
700x450	728x478	580x375	8,7	31661	226,-
800x340	828x368	680x265	7,8	31656	207,-
800x400	828x428	680x325	8,9	31651	222,-
800x450	828x478	680x375	9,9	31655	245,-
900x450	928x478	780x375	10,8	31662	239,-
900x500	928x528	780x425	11,8	31663	299,-
960x450	988x478	840x375	11,4	31652	262,-
1000x500	1028x528	880x425	12,9	31664	309,-

RW Motion blackout system

OPTIONALLY AVAILABLE | **DARKENING PLISSEE** | **MOSKITO-PROTECTION PLISSEE** | **MATERIAL FRAME: PVC**

Outer dims. W x H (mm)	Item no.	Price
567x407	316571	78,-
567x457	316501	93,90
567x557	316541	89,-
667x457	316531	87,-
667x557	316581	112,-
767x407	316591	89,-
767x507	316601	97,-
767x557	316611	89,-
867x447	316561	112,-
867x507	316511	116,-
867x557	316551	99,-
967x557	316621	99,-
967x607	316631	111,-
1027x557	316521	116,-
1067x607	316641	118,-

TINTED UNIVERSAL SAFETY GLASS WINDOWS

SAFETY GLASS LIGHT-THROUGH-TRANSMISSION: 18% LEFT AND RIGHT MOUNTABLE CORNER RADIUS WINDOW-FRAME: 50 mm **E** ECE R43

Outer dimension W x H (mm)	Weight (kg)	Item no.	Price
460x280	1,3	31720	199,-
500x350	1,7	31721	239,-
500x450	2,2	31722	242,-
600x350	2,1	31723	254,-
800x340	2,6	31724	234,-
800x450	3,5	31725	279,-
900x450	3,9	31726	289,-



ACRYLIC GLASS SLIDING WINDOWS RW STYLE SLIDE

RW Style Slide and RW Style go well together on the vehicle, as they have the same look



NEW 2024

Black matt



OPTIONAL

Blackout system w/ privacy & mosquito protection Pleated blind w/ magnetic closure. NEW: With matt black frame and black pleated blinds in a very high-quality look.

Tinted acrylic glass sliding windows RW Style Slide

ACRYLIC GLASS DOUBLE GLAZED LIGHT-THROUGH-TRANSMISSION: 10% UV RESISTANT LEFT AND RIGHT MOUNTABLE MATERIAL FRAME: ALUMINIUM FOR WALL-THICKNESS FROM 30-45 mm **E** ECE R43

Detail W x H (mm)	Outer dims. W x H (mm)	Viewing approx. W x H (mm)	Window opening W x H (mm)	Weight (kg)	Item no.	Price
500x450	527x477	330x330	120x373	2,7	318022	249,-
700x300	727x327	520x180	220x223	2,6	318023	269,-
700x400	727x427	520x280	220x323	4,0	318024	289,-
900x450	927x477	720x330	320x373	4,8	318025	373,-
1000x500	1027x527	820x380	370x423	5,9	318026	429,-

RW Style Slide blackout system

OPTIONALLY AVAILABLE DARKENING PLISSEE MOSKITO-PROTECTION PLISSEE MATERIAL FRAME: ALUMINIUM

Outer dims. W x H (mm)	Item no.	Price	Item no.	Price
528x478	3180010	93,-	3180012	93,-
728x328	31800130	97,-	31800132	97,-
728x428	3180020	103,-	3180022	103,-
928x478	3180030	118,-	3180032	118,-
1028x528	31800170	128,-	31800172	128,-

ACRYLIC HINGED WINDOW RW STYLE

RW Style and RW Style Slide go well together on the vehicle, as they have the same look



Window closes outside flush with the frame



Additional safety-latch on Closure latch

NEW
2024
Black matt

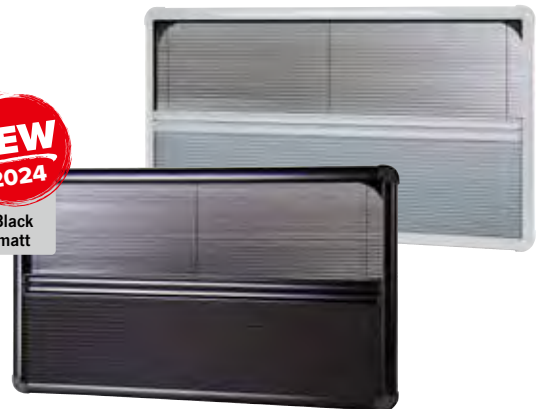

OPTIONAL

Blackout system w/ privacy & mosquito protection- Pleated blind w/ magnetic closure. NEW: With matt black frame and black pleated blinds in a very high-quality look.

Acrylic glass hinged window RW Style

- ACRYLIC GLASS
- DOUBLE GLAZED
- LIGHT-THROUGH-TRANSMISSION: 10%
- DISK TO INSIDE CURVED
- UV RESISTANT
- WITH VENTILATION-POSITION
- MATERIAL FRAME: ALUMINIUM
- FOR WALL-THICKNESS FROM 30-35 mm
- E** ECE R43

RW Style blackout system

- OPTIONALLY AVAILABLE
- DARKENING PLISSEE
- MOSKITO-PROTECTION PLISSEE
- MATERIAL FRAME: ALUMINIUM

Detail W x H (mm)	Outer dims. WxH(mm)	Review approx. WxH(mm)	Max. Opening	Exhibitor (2 pcs.)	kg	Item no.	Price	Outer dims. WxH(mm)	Item no.	Price	Item no.	Price
350x500	377x527	295x425	70°	Stainless steel stepless	2,9	318009	166,-	378x528	3180090	84,-	---	---
460x220	487x247	405x145	37°	Plastic 3 level	2,3	318010	154,-	688x248	31800100	79,-	---	---
500x300	527x327	445x225	37°	Plastic 3 level	2,6	318011	159,-	528x328	31800110	79,-	---	---
500x350	527x377	445x275	36°	Stainless steel stepless	3,1	318000	167,-	528x378	3180000	88,-	3180002	88,-
500x450	527x477	445x375	60°	Stainless steel stepless	3,4	318001	186,-	528x478	3180010	93,-	3180012	93,-
600x450	627x477	545x375	68°	Stainless steel stepless	3,9	318012	215,-	628x478	31800120	96,-	---	---
700x300	727x327	645x225	37°	Plastic 3 level	3,4	318013	197,-	728x328	31800130	97,-	31800132	97,-
700x400	727x427	645x325	47,5°	Stainless steel stepless	4,1	318002	205,-	728x428	3180020	103,-	3180022	103,-
700x450	727x477	645x375	68°	Stainless steel stepless	4,4	318014	252,-	728x478	31800140	105,-	---	---
800x450	827x477	745x375	68°	Stainless steel stepless	4,9	318015	275,-	828x478	31800150	112,-	31800152	112,-
900 x 450	927x477	845x375	60°	Stainless steel stepless	5,4	318003	282,-	928x478	3180030	118,-	3180032	118,-
900x500	927x527	845x425	70°	Stainless steel stepless	5,8	318016	318,-	928x528	31800160	125,-	---	---
1000x500	1027x527	945x425	70°	Stainless steel stepless	6,3	318017	343,-	1028x528	31800170	128,-	31800172	128,-
1000x800	1027x827	945x725	47°	Stainless steel stepless	8,8	318004	370,60	1028x828	3180040	143,-	---	---
1100x450	1127x477	1045x375	60°	Stainless steel stepless	6,4	318005	328,-	1128x478	3180050	130,-	---	---
1200x300	1227x327	1145x225	37°	Stainless steel stepless	5,4	318006	296,-	1228x328	3180060	109,-	---	---
1200x500	1227x527	1145x425	65°	Stainless steel stepless	7,3	318007	368,-	1228x528	3180070	135,-	3180072	135,-
1450x550	1477x577	1395x475	50°	Stainless steel stepless	9,2	318008	419,-	1478x578	3180080	139,-	---	---



Please pay attention during installation of the windows to ensure that the adhesive surfaces load-bearing, dust-, are free of adhesives and grease.



Danger



For mounting acrylic glass windows, we recommend:

DEKaseal 8936

Can be used without primer. Dabable Sealant for window frames, open exterior surfaces, drains, skylights, hoses and cable ducts. Application on paints, aluminum, ABS, PMMA or wood.

310 ml Anthracite 50030 GP* 60.97/ 1 liter 18,90
310 ml Black 500314 GP* 60.97/ 1 Liter 18,90

Danger: H315, H412

Technical product improvements possible in the course of the year. You can find detailed product descriptions at www.reimo.com

ACRYLIC HINGED WINDOW COMFORT



Window closes outside flush with the frame

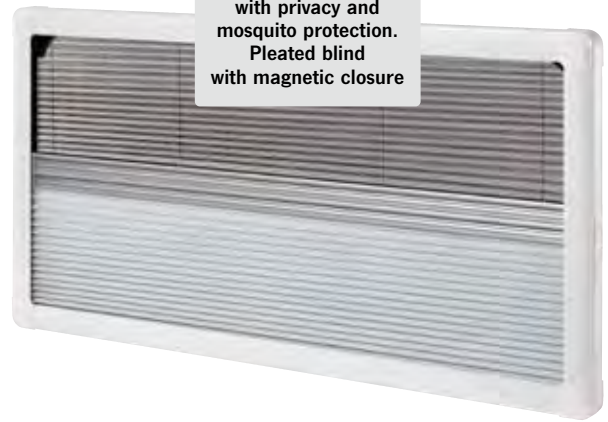

OPTIONALLY

Blackout system with privacy and mosquito protection. Pleated blind with magnetic closure

Acrylic glass hinged window Comfort

Blackout system Comfort

ACRYLIC GLASS **DOUBLE GLAZED** **LIGHT-THROUGH-TRANSMISSION: 40%** **DISK TO INSIDE CURVED** **UV RESISTANT**
WITH VENTILATION-POSITION **MATERIAL FRAME: ALUMINIUM** **FOR WALL-THICKNESS FROM 28-32 mm** **CORNER RADIUS WINDOW-FRAME: 75mm** **ECE R43**

OPTIONALLY AVAILABLE **DARKENING PLISSEE** **MOSKITO-PROTECTION PLISSEE** **MATERIAL FRAME: ALUMINIUM**

Detail W x H (mm)	Outer dims. W x H (mm)	Viewing approx. W x H (mm)	Max. Opening (degree)	Exhibitor (2 pcs.)	Weight (kg)	Item no.	Price	Outer dims. W x H (mm)	Item no.	Price
350x500	380x530	295x425	70°	Stainless steel stepless	1,9	318100	161,-	392x542	3181000	79,-
500x300	530x330	445x225	2/17/30°	Plastic 3 level	1,9	318101	148,-	542x342	3181001	71,-
500x350	530x380	445x275	2/17/30°	Plastic 3 level	2,0	318102	162,-	542x392	3181002	79,-
500x450	530x480	445x375	70°	Stainless steel stepless	2,1	318103	190,-	542x492	3181003	94,-
600x450	630x480	545x375	70°	Stainless steel stepless	2,4	318104	217,-	642x492	3181004	107,-
700x300	730x330	645x225	2/17/30°	Plastic 3 level	2,5	318105	191,-	742x342	3181005	94,-
700 x 400	730x430	645x325	70°	Stainless steel stepless	2,6	318106	226,-	742x442	3181006	111,-
700 x 450	730x480	645x375	70°	Stainless steel stepless	2,7	318107	248,-	742x492	3181007	103,-
800 x 450	830x480	745x375	70°	Stainless steel stepless	3,0	318108	277,-	842x492	3181008	119,-
900 x 450	930x480	845x375	70°	Stainless steel stepless	3,2	318109	301,-	942x492	3181009	119,-
900 x 500	930x530	845x425	70°	Stainless steel stepless	3,4	318110	325,-	942x542	3181010	139,-
1000x500	1030x530	945x425	70°	Stainless steel stepless	3,6	318111	354,-	1042x542	3181011	139,-

Technical product improvements possible in the course of the year. You can find detailed product descriptions at www.reimo.com

ACRYLIC HINGED WINDOW RW COMPACT

RW Compact and RW Van go well together on the vehicle, as they have the same look



Window closes outside flush with the frame

NEW 2024
Black matt

OPTIONAL
Blackout system w/ privacy & mosquito protection-
Pleated blind w/ magnetic closure. NEW: With matt black frame and black pleated blinds in a very high-quality look.

Acrylic glass hinged window RW Compact

- ACRYLIC GLASS
- DOUBLE GLAZED
- LIGHT-THROUGH-TRANSMISSION: 10%
- DISK TO INSIDE CURVED
- UV RESISTANT
- WITH VENTILATION-POSITION
- MATERIAL FRAME: ALUMINIUM
- FOR WALL-THICKNESS FROM 30-32 mm
- CORNER RADIUS WINDOW-FRAME: 75mm
- ECE R43

RW Compact blackout system

- OPTIONALLY AVAILABLE
- DARKENING PLISSEE
- MOSKITO-PROTECTION PLISSEE
- MATERIAL FRAME: ALUMINIUM

Detail W x H (mm)	Outer dims. W x H (mm)	Viewing approx. W x H (mm)	Max. Opening	Exhibitor (2 pcs.)	(kg)	Item no.	Price	Outer dims. W x H (mm)	Item no.	Price	Item no.	Price
350x500	378x528	290x430	63°	Stainless steel stepless	2,2	31890	184,-	377x544	318901	105,-	318902	95,50
500x300	528x328	440x260	37°	Plastic 3 level	2,1	31891	163,-	527x344	318911	104,-	318912	104,-
500x350	528x378	440x290	40°	Stainless steel stepless	2,2	31901	182,-	527x394	319011	103,-	319012	103,-
500x450	528x478	440x390	57°	Stainless steel stepless	2,8	31892	213,-	527x494	318921	109,-	318922	109,-
600x450	628x478	540x390	57°	Stainless steel stepless	3,4	31899	220,-	627x494	318991	121,-	318992	121,-
700x300	728x328	640x240	37°	Plastic 3 level	2,9	31893	213,-	727x344	318931	119,-	318932	119,-
700 x 400	728x428	640x340	54°	Stainless steel stepless	3,5	31900	233,-	727x444	319001	125,-	319002	125,-
700 x 450	728x478	640x390	57°	Stainless steel stepless	3,6	31902	263,-	727x494	319021	129,-	319022	118,-
800 x 450	828x478	740x390	57°	Stainless steel stepless	4,2	31894	310,-	827x494	318941	136,-	318942	136,-
900 x 450	928x478	840x390	57°	Stainless steel stepless	4,7	31895	318,-	927x494	318951	139,-	318952	139,-
900 x 500	928x528	840x440	64°	Stainless steel stepless	5,0	31896	321,-	927x544	318961	145,-	318962	145,-
1000x500	1028x528	940x440	57°	Stainless steel stepless	5,4	31897	336,-	1027x544	318971	151,-	318972	151,-

Technical product improvements possible in the course of the year. You can find detailed product descriptions at www.reimo.com

ACRYLIC HINGED WINDOW RW VAN

RW Van and RW Compact go well together on the vehicle, as they have the same look

The curved aluminum frame (radius: 5000 mm) adapts perfectly to the contours of the vehicle.

Window closes outside flush with the frame



OPTIONAL

Blackout system w/ privacy & mosquito protection- Pleated blind w/ magnetic closure. NEW: With matt black frame and black pleated blinds in a very high-quality look.

Acrylic glass hinged window RW Van

ACRYLIC GLASS	DOUBLE GLAZED	LIGHT-THROUGH-TRANSMISSION: 10%	DISK TO INSIDE CURVED	UV RESISTANT
WITH VENTILATION-POSITION	MATERIAL FRAME: ALUMINIUM	FOR WALL-THICKNESS FROM 32-34 mm	CORNER RADIUS WINDOW-FRAME: 75mm	ECE R43

RW Van blackout system

OPTIONALLY AVAILABLE	DARKENING PLISSEE	MOSKITO-PROTECTION PLISSEE	MATERIAL FRAME: ALUMINIUM
-----------------------------	--------------------------	-----------------------------------	----------------------------------

Detail W x H (mm)	Outer dims. W x H (mm)	Viewing approx. W x H (mm)	Max. Opening	Exhibitor (2 pcs.)	(kg)	Item no.	Price	Outer dims. W x H (mm)	Item no.	Price	Item no.	Price
280x380	308x407	225x325	40°	Stainless steel stepless	1,7	31911	215,-	307x420	319111	117,-	319112	117,-
350x500	377x527	295x445	63°	Stainless steel stepless	2,6	31929	275,-	377x540	319291	142,-	319292	142,-
490x500	518x527	435x445	63°	Stainless steel stepless	3,0	31912	294,-	517x540	319121	151,-	319122	151,-
500x300	528x327	445x245	37°	Plastic 3 level	3,1	31924	254,-	527x340	319241	137,-	319242	137,-
500x500	528x527	445x445	63°	Stainless steel stepless	3,0	31919	295,-	527x540	319191	152,-	319192	152,-
600x450	628x477	545x395	57°	Stainless steel stepless	3,3	31917	321,-	627x490	319171	132,-	319172	132,-
600x600	628x627	545x545	58°	Stainless steel stepless	4,0	31925	356,-	627x640	319251	172,-	319252	172,-
750x455	778x477	695x400	56°	Stainless steel stepless	3,9	31913	346,-	777x495	319131	177,-	319132	177,-
800x500	828x527	745x445	63°	Stainless steel stepless	4,5	31927	365,-	827x540	319271	153,-	319272	153,-
818x315	846x342	763x260	37°	Plastic 3 level	3,3	31914	299,-	845x355	319141	153,-	319142	153,-
900 x 400	928x427	845x345	55°	Stainless steel stepless	4,2	31918	391,-	927x440	319181	166,-	319182	166,-
900x450	928x477	845x395	57°	Stainless steel stepless	4,4	31916	403,-	927x490	319161	172,-	319162	172,-
900x500	928x527	845x445	63°	Stainless steel stepless	4,9	31928	404,-	927x540	319281	176,-	319282	176,-
960x450	988x477	905x395	57°	Stainless steel stepless	4,8	31910	419,-	987x490	319101	162,-	319102	162,-
985x465	1013x482	930x410	52°	Stainless steel stepless	5,1	31915	442,-	1012x505	319151	188,-	319152	188,-
1100x600	1128x627	1045x545	58°	Stainless steel stepless	6,7	31926	492,-	1127x640	319261	209,-	319262	209,-

Technical product improvements possible in the course of the year. You can find detailed product descriptions at www.reimo.com

ACRYLIC HINGED WINDOW CLASSIC



INCLUSIVE
 Blackout system
 with privacy and
 Mosquito protection.
 Pleated blind
 with magnetic closure



Classic acrylic glass hinged window

ACRYLIC GLASS	DOUBLE GLAZED	LIGHT-THROUGH-TRANSMISSION: 40%	DISK TO OUTSIDE CURVED	UV RESISTANT
EXHIBITOR WITH FIXED-SCREW	MATERIAL FRAME: ASA	FOR WALL-THICKNESS FROM 28-32 mm	CORNER RADIUS WINDOW-FRAME: 12 mm	E ECE R43

Detail W x H (mm)	Outer dims. W x H (mm)	Viewing approx. W x H (mm)	Max. Opening (degree)	Weight (kg)	Item no.	Price
500 x 300	529 x 329	375x175	32°	2	318581	274,-
500 x 350	529 x 379	375x225	60°	3,7	318580	279,-
500 x 450	529 x 479	375x325	70°	4,2	31858	313,-
700 x 400	729x429	575x275	70°	5,5	31859	366,-
900x450	929x479	775x325	70°	7,0	31857	377,-
900x550	929x579	775x425	70°	8,0	318582	405,-
1100x450	1129x479	975x325	70°	8,5	31855	399,-
1200x500	1229x529	1075x375	78°	9,5	31868	467,-
1450x550	1479x579	1375x425	70°	13,0	31869	589,-

Classic blackout system

IN SUPPLY-SCOPE INCLUDED	DARKENING PLISSEE	MOSKITO-PROTECTION PLISSEE	MATERIAL FRAME: PLASTIC
--------------------------	-------------------	----------------------------	-------------------------

ACRYLIC HINGED WINDOW ELEGANCE



Window closes outside flush with the frame

INCLUSIVE
 Blackout system
 with privacy and
 Mosquito protection.
 Pleated blind
 with magnetic closure



Elegance acrylic glass hinged window

ACRYLIC GLASS	DOUBLE GLAZED	LIGHT-THROUGH-TRANSMISSION: 40%	DISK TO INSIDE CURVED	UV RESISTANT	WITH VENTILATION-POSITION
EXHIBITOR WITH FIXED-SCREW	MATERIAL FRAME: ASA	FOR WALL-THICKNESS FROM 28-32 mm	CORNER RADIUS WINDOW-FRAME: 12 mm	E ECE R43	

Detail W x H (mm)	Outer dims. W x H (mm)	Viewing approx. W x H (mm)	Max. Opening (degree)	Weight (kg)	Item no.	Price
500 x 350	529 x 379	400x265	45°	3,2	318500	237,15
500 x 450	529 x 479	400x365	45°	3,75	318501	254,15
900x350	929x379	800x265	45°	6,32	318507	365,-
900x450	929x479	800x365	45°	5,93	318502	388,-
1000x800	1029x829	900x715	50°	12,4	318506	488,75
1100x450	1129x479	1000x365	45°	7,05	318503	352,75
1200x300	1229x329	1100x215	12°	7,67	318504	324,70
1200x500	1229x529	1100x415	45°	8,09	318505	412,25

Elegance blackout system

IN SUPPLY-SCOPE INCLUDED	DARKENING PLISSEE	MOSKITO-PROTECTION PLISSEE	MATERIAL FRAME: PLASTIC
--------------------------	-------------------	----------------------------	-------------------------

CURTAIN-TYPE ACRYLIC GLASS HINGED WINDOW FOR PANEL VANS



The curved acrylic glass (Radius: 5800 mm) adapts perfectly to the vehicle contour



OPTIONALLY
Blackout system with privacy and Mosquito protection. Pleated blind with magnetic closure

Acrylic glass Hinged window RW Rear

ACRYLIC GLASS

DOUBLE GLAZED

LIGHT-THROUGH-TRANSMISSION: 10%

DISK TO OUTSIDE CURVED

UV RESISTANT

3 LEVELS-ADJUSTER

FRAMELESS

E
ECE R43

RW Rear blackout system

OPTIONALLY AVAILABLE

DARKENING PLISSEE

MOSKITO-PROTECTION PLISSEE

MATERIAL FRAME: ALUMINIUM

Installation position	Detail W x H (mm)	Outer dims. W x H (mm)	Max. Opening (degree)	Weight (kg)	Item no.	Price	Outer dims. W x H (mm)	Item no.	Price
Page	260x560	340x653	60°	1,6	31920	169,-	347x669	319201	102,-
Page	735x560	814x653	60°	4,6	31922	243,-	822x669	319221	119,-
Sliding door	970x560	1050x653	60°	5,8	31923	274,-	1057x669	319231	129,-
Rear	620x560	700x653	60°	4,1	31921	199,-	707x669	319211	117,-

Rear window does not fit with the 270° door hinges (Fiat Ducato). Not suitable for replacing the original glazing.

Order at the same time:

① Sealing rubber profile self-adhesive, for curtain wall windows

For wall thicknesses of 28-32 mm. Self-adhesive. Colour: Black

4 m GP* 14,99/1 m **322704** **59,95**

40 m GP* 13,97/1 m **3227040** **559,-**

② Filler profile for rubber sealing profile 322704/3227040

Colour: grey, dims.: 23 mm x 0.9 mm.

10 m GP* 1,23/1 m **322730** **12,30**

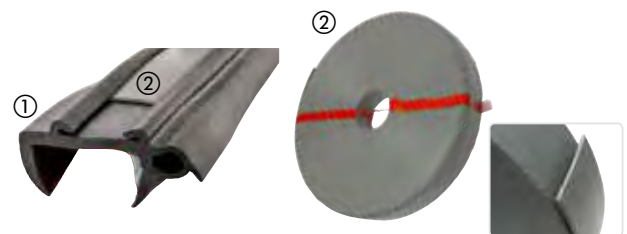

Sliding window for horse trailers - RW TRAILER

Window for horse trailers with protective grid, provides ventilation as well as protection from insects due to integrated mosquito net. Lockable and lockable from the outside. For 40 mm wall thickness, corner radius 100 mm.

Width 790 mm, height 515 mm **31970** **296,65**

① Porthole - RW NAUTIC Ø 295 mm

- Tinted acrylic
- Double glazed
- UV-resistant
- Powder coated aluminum frame, black
- For wall thicknesses of 40 mm

Rigid version (cannot be opened), outer Ø: 323 mm, window Ø: 295 mm. Weight: approx. 1.4 kg.

32263 **109,-**

② Darkening system for RW NAUTIC

- With privacy and Mosquito protection pleated blind with magnetic closure.

Aluminum frame, white. Overall dims.: 374x318 mm, weight: app. 1 kg

322631 **59,90**



②



ROOF HOODS 28x28 cm



① 28x28 cm

Ideal for wet rooms and sanitary areas



② 28x28 cm

12V VENT



With 12 V fan

Fan can rotate in both directions: For ventilation or air extraction. Technical data fan: Power: 9.6W, capacity 9^{m³/n}, noise level ≤ 50dB, Ø 175 mm, 5 fan blades.

Model	①	②
Cut-out dimension (mm)	280x280	280x280
Overall dimension (mm)	365x365	365x365
Installation height (mm)	85	85
Roof thickness (mm)	25-65	25-65
Opening angle	50°	50°
Pleated blinds	—	—
Mosquito protection	✓	✓
LED lighting	—	—
Forced ventilation / ventilation opening	—	—
12V fan	—	✓
Hood	Clear	White
Glazing	Single	Single
UV protection	✓	✓
Weight (kg)	2,1	2,3
Item no.	318530	31853
Price	69,95	87,95

ROOF HOODS 40x40 cm



① 40x40 cm

Gas pressure stand

Metal closing bracket



② 40x40 cm

12V LEDS



Inner frame with or without LED ambient lighting

Model	①		②	
Cut-out dimension (mm)	400x400	400x400	400x400	400x400
Overall dimension (mm)	500x500	530x490	530x490	530x490
Installation height (mm)	106	120	120	120
Roof thickness (mm)	30-50	28-50	28-50	28-50
Opening angle	70°	50°	50°	50°
Pleated blinds	—	✓	✓	✓
Mosquito protection	✓	✓	✓	✓
LED lighting	—	✓	✓	—
Forced ventilation / ventilation opening	—	—	✓ 100mm ²	—
12V fan	—	—	—	—
Hood	Green tinted	Grey tinted	Grey tinted	Grey tinted
Glazing	Single	Double	Double	Double
UV protection	✓	✓	✓	✓
Weight (kg)	4,3	3,5	8,3	8,3
Item no.	31888	318020	318027	318021
Price	124,90	124,90	124,90	149,-

When fitting a roof hood, we also recommend fitting a front spoiler. Recommended maximum vehicle speed: 130 km/h.



PROTECTIVE COVERS 40x40 cm

Perfect fit Protective cover for CARBEST roof hoods: 318020/318021/318027/31888

- Protects against scratches, dirt and hail damage
- High-quality multi-layer insulation ensures pleasant temperatures in the interior
- Prevents the vehicle from heating up in the Summer and insulated in winter
- UV-resistant material

Supplied without roof hood.

420603

30,50

ROOF HOODS 45x40 cm



Model	①		②	
Cut-out dimension (mm)	450x400	450x400	450x400	450x400
Overall dimension (mm)	577x577	577x577	577x577	577x577
Installation height (mm)	98	98	98	98
Roof thickness (mm)	25-60	25-60	25-60	25-60
Opening angle	60°	60°	60°	60°
Pleated blinds	✓	✓	✓	✓
Mosquito protection	✓	✓	✓	✓
LED lighting	✓	✓	✓	✓
Forced ventilation / ventilation opening	—	182mm ²	—	182mm ²
12V fan	—	—	—	—
Hood	Grey tinted	Grey tinted	Grey tinted	Grey tinted
Glazing	Double	Double	Double	Double
UV protection	✓	✓	✓	✓
Weight (kg)	5,5	5,5	5,8	5,8
Item no.	31851	318510	31877	318770
Price	249,-	279,-	279,-	289,-

ROOF HOODS 70x50 cm



Model	①		②	
Cut-out dimension (mm)	700x500	700x500	700x500	700x500
Overall dimension (mm)	833x633	833x633	818x617	818x617
Installation height (mm)	98	98	98	98
Roof thickness (mm)	25-60	25-60	25-60	25-60
Opening angle	60°	60°	60°	60°
Pleated blinds	✓	✓	✓	✓
Mosquito protection	✓	✓	✓	✓
LED lighting	✓	✓	✓	✓
Forced ventilation / ventilation opening	—	300mm ²	—	300mm ²
12V fan	—	—	—	—
Hood	Grey tinted	Grey tinted	Grey tinted	Grey tinted
Glazing	Double	Double	Double	Double
UV protection	✓	✓	✓	✓
Weight (kg)	8,0	8,0	8,3	8,3
Item no.	31854	318540	31878	318780
Price	469,-	469,-	444,-	469,-

When fitting a roof hood, we also recommend fitting a front spoiler. Recommended maximum vehicle speed: 130 km/h.

PROTECTIVE COVERS 70x50 cm

Custom-fit protective cover for CARBEST roof hoods: 31878/318780/31854/318540

- Protects against scratches, dirt and hail damage
- High-quality multi-layer insulation ensures pleasant temperatures in the interior
- Prevents the vehicle from heating up in the Summer and insulated in winter
- UV-resistant material

Supplied without roof hood.

420601

43,90



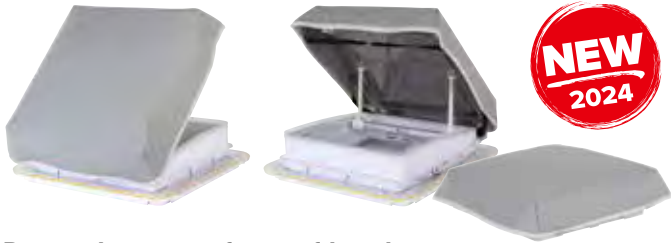

Protective cover for roof hoods

- Protects against scratches, dirt and hail damage
- High-quality multi-layer insulation ensures a pleasant Temperatures in the interior
- UV-resistant material

CARBEST roof hoods 318020/318021/318027/31888	420603	30,50
CARBEST roof hoods 31878/318780/31854/318540	420601	43,90
MPK Vision Star M	420604	43,50
MPK Vision Star L	420605	45,50
REMItop Vista and Vario II	420603	30,50
Dometic Mini Heki	420600	30,50
Dometic Midi Heki	420601	43,90
Dometic Heki 1/2/3/4	420602	45,50



SOLAR FANS

Solar-powered fan for active air exchange
For motorhomes, caravans, boats

① Stainless steel solar fan

Technical data: Air flow: 19 m³/h in full sunshine. Power: 1.2 W, 0.6 A at full sunshine, Ø 215 mm, height above roof 36 mm, interior depth 40 mm, cut-out dimension Ø 120 mm

35231 75,50

② Solar fan plastic white, with switch

Technical data: Air flow: 19 m³/h in full sunshine. Power: 1.2 W, 0.6 A at full sunshine, Ø 215 mm, height above roof 50 mm, interior depth 40 mm. Cut-out dimension Ø 120 mm.

35230 74,95

The entire CARBEST window range
can also be found in our broad
Online store **www.carbest.de**

Find your desired product quickly:

Enter the article number in the search field,
order items and collect them from your local
specialist dealer.





VANVENT 400x400 ROOF VENTILATION SYSTEM

12 V	40x40 cm	UV RESISTANT	DARKENING	MOSQUITO PROTECTION	LEDS	REMOTE CONTROL	ECE R43	max. 130 km/h
------	----------	--------------	-----------	---------------------	------	----------------	---------	---------------

- For roof cut-outs of 40x40 cm
- Ventilation (with open external hood)
- Ceiling fan (with closed external hood)
- Integrated pleated blackout blind
- Metal insect screen
- Shockproof and UV-resistant
- Includes remote control with illuminated display and wall bracket
- ECE-tested

The VanVent roof ventilation system ensures a pleasant climate in the interior. When the outer hood is open, the supply of Outdoor air or indoor air extraction. When hood is closed, the VanVent turns into a roof ventilator and circulates the air in the interior. The special design prevents the ingress of rainwater. It is controlled via the remote control or via the LED display on the inner frame.

max. ventilation flow: 3000m³/h
 max. power: 20W + 4W
 Operating voltage: min. 9V - max. 16V
 LED lighting, warm white: 3000K
 Cutout size: 400x400 mm
 For roof thicknesses from: 27-80 mm Weight: 4.5 kg

VanVent smoked glass	318028	379,-
VanVent Black	318029	379,-

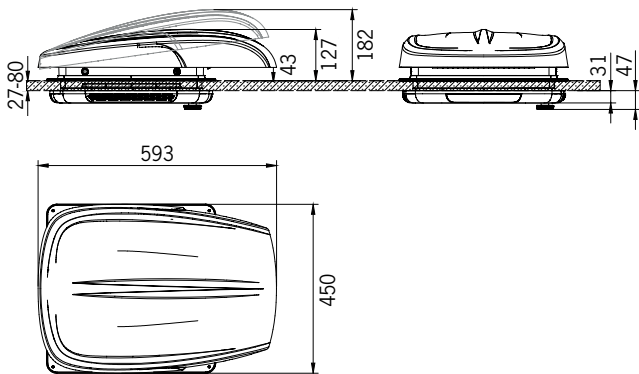

Inner frame with LED display, LED lighting, integrated pleated blind and mosquito screen. The roof hood can also be opened manually using the rotary knob or closed.



Warm white LED lighting on the side



Illuminated LED operating display



Remote control with LED operating display and wall bracket

ISOFLEX THERMAL MATS

- 9-layer Isoflex material (PVC)
- Insulation against heat and cold
- The ideal privacy screen
- Suction cups included

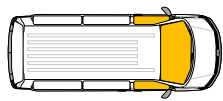

Driver's cab, 3-piece set

For vehicles with short and long wheelbase

Suction cups
inclusive



Vehicle type	YOC.	Item no.	Price
Citroën Berlingo	2008 - 2018	37364	59,95
Citroën Jumpy/Spacetourer/ Peugeot Expert/Traveller/Opel Vivaro/ Toyota Proace	> 2016	373133	59,95
Citroën Spacetourer Campster/ Vanster (Pössl)	> 2017	37346	59,95
Fiat Ducato Citroën Jumper/Peugeot Boxer	1990 - 1993	37245	59,95
Fiat Ducato 230 Citroën Jumper/ Peugeot Boxer	1994 - 2001	37246	59,95
Fiat Ducato 244 Citroën Jumper/ Peugeot Boxer	2002 - 2005	37270	59,95
Fiat Ducato 250 Citroën Jumper/ Peugeot Boxer	2006 - 2014	37315	59,95
Fiat Ducato 290 Citroën Jumper/ Peugeot Boxer	> 2015	37313	59,95
Ford Transit	2000 - 2006	37269	59,95
Ford Transit	2006 - 2014	372691	59,95
Ford Transit	> 2015	372692	59,95
Ford Custom	2012-2022	372690	59,95
Iveco Daily	2000 - 2006	37361	59,95
Iveco Daily	2006 - 2014	37362	59,95
Iveco Daily	> 2014	37363	59,95

Mercedes-Benz Sprinter	1995 - 2006	37242	59,95
Mercedes-Benz Sprinter	2006 - 2018	372421	59,95
Mercedes-Benz Sprinter	> 2018	37213	59,95
Mercedes-Benz Vito	> 2015	372693	59,95
Pössl Vanstar + Campstar			
Nissan NV200 5-piece / 5-ply	2009 - 2021	37320	64,20
Renault Master	2005 - 2010	37274	59,95
Renault Master	> 2011	37349	59,95
Renault Trafic	> 2001	372732	59,95
Renault Trafic II/Nissan NV300/ Opel Vivaro A	2002 - 2014	37273	59,95
Renault Trafic III/Nissan NV300/ Opel Vivaro B	> 2015	372731	59,95
Volkswagen Caddy	2004 - 2020	37226	59,95
Volkswagen Caddy 5	> 2020	372261	59,95
Volkswagen Crafter	2006 - 2016	372421	59,95
Volkswagen Crafter	> 2017	372422	59,95
Volkswagen LT	< 1996	37238	59,95
Volkswagen T2/T3	1979 - 1990	37230	59,95
Volkswagen T4	> 1990	37232	59,95
Volkswagen T6.1/T6/T5	> 2003	37281	59,95
Volkswagen New Multivan	> 2021	372423	59,95
Volkswagen ID BUZZ	> 2023	372440	59,95

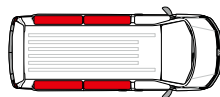

Living room, 4 piece set

Vehicle type	Wheelbase	YOC.	Item no.	Price
Citroën Jumpy/ Spacetourer/ Peugeot Expert/Traveller/ Opel Vivaro/Toyota Proace	SWB medium long	> 2016	373401 373402 373403	79,95 79,95 79,95
Citroën Campster Citroën Vanster	medium	> 2017	37347	59,95
Mercedes Benz Vito/ Pössl Vanstar + Campstar	SWB	> 2015	372445	89,95
Volkswagen T2/T3	SWB	1979 - 1990	37237	79,95
Volkswagen T4	SWB	> 1990	37235	79,95
Volkswagen T4	long	> 1990	37236	79,95

VW T4	SWB with climatic roof	> 1990	37252	79,95
Volkswagen T5/T6 panel van, Multivan Startline, California Beach up to 6/2010 with hard fiber trim:				
Volkswagen T5/T6¹	SWB	> 2003	37296	59,95
Volkswagen T5/T6²	LWB	> 2003	37297	59,95
Volkswagen T5/T6 Caravelle, Multivan, California with comfort interior trim:				
Volkswagen T5/T6³	SWB	> 2003	37311	79,95
Volkswagen T5/T6⁴	long	> 2003	37312	79,95
Volkswagen New Multivan	SWB	> 2021	372424	79,95
Volkswagen New Multivan	long	> 2021	372431	87,95
VW ID BUZZ	-	> 2023	372441	87,95

¹ w/o. VW comfort trim (hard fiber), station wagon, Multivan Startline up to 6/2010 T5 California up to 6/2010 | ² w/o. VW comfort trim (hard fiber), station wagon

³ with comfort trim, Caravelle, Multivan from 2003, Multivan Startline from 7/2010, California from 2003, California Beach from 7/2010 |

⁴ with comfort cladding, Caravelle from 2003

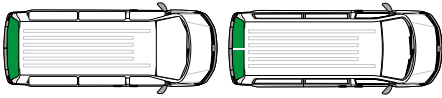

Rear window 1-piece / rear door 2-piece set

For vehicles with short and long wheelbase

Vehicle type	YOC.	Parts	Item no.	Price					
Citroën Jumpy/Spacetourer/ Peugeot Expert/Traveller/Opel Vivaro/Toyota Proace	> 2016	1 2	373404 373405	21,95 21,95	Mercedes-Benz Vito/ Pössl Vanstar + Campstar	> 2015	1	372446	22,30
Fiat Ducato 230 Citroën Jumper/Peugeot Boxer	1994 - 2001	2	372462	21,01	Renault Master	2005 - 2010	2	372333	21,95
Fiat Ducato 244 Citroën Jumper/Peugeot Boxer	2002 - 2005	2	372701	21,01	Renault Master	> 2011	2	372334	21,95
Fiat Ducato 250 Citroën Jumper/Peugeot Boxer	2006 - 2014	2	373151	21,95	Renault Trafic II	2002 - 2014	2	372335	21,95
Fiat Ducato 290 Citroën Jumper/Peugeot Boxer	> 2015	2	373131	21,95	Renault Trafic III	> 2015	2	372336	21,95
Ford Transit	1986 - 1989	1	37233	21,95	Volkswagen T3	9/79 - 7/90	1	37231	21,95
Ford Transit	2000 - 2006	1	372330	18,66	Volkswagen T4	> 1990	1	37233	21,95
Ford Transit	2006 - 2014	2	372331	21,01	Volkswagen T4 low doors	> 1990	2	37234	21,95
Ford Transit	> 2015	2	372332	21,01	Volkswagen T5/T6²	> 2003	1	37283	21,95
					Volkswagen T5/T6³	> 2003	2	37282	21,95
					VW T5/T6⁴	> 2003	1	37306	27,95
					Volkswagen New Multivan	> 2021	1	372425	22,30
					Volkswagen ID BUZZ	> 2023	1	372442	22,30

¹ Panel van, Multivan Startline, California Beach up to 6/2010 with hard fiber cladding: | ² without Volkswagen comfort paneling (hard fiber), station wagon, Multivan Startline up to 6/2010, California Beach up to 6/2010 | ³ without comfort trim, estate | ⁴ with Volkswagen comfort trim, Caravelle from 2003, Multivan from 2003, Multivan Startline from 7/2010, California from 2003, California Beach from 7/2010

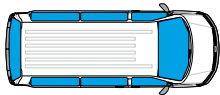

Complete set 8-piece (with rear window) / 9-piece (with rear door) / 12-piece

Vehicle type	Wheelbase	YOC.	Parts	Item no.	Price						
Citroën Spacetourer Campster/ Vanstar (Pössl)	medium	> 2017	8	372813	157,95	Renault Kangoo II	SWB	2008 - 2021	8	372291	157,95
Ford Tourneo Custom	SWB	2012 - 2022	8	37123	157,95	Renault Kangoo II	SWB	2008 - 2021	9	372290	157,95
Ford Tourneo Custom	SWB	2012 - 2022	9	37124	157,95	Renault Trafic II	SWB	2002 - 2014	8	37215	157,95
Ford Tourneo Custom	long	2012 - 2022	8	37125	157,95	Renault Trafic II	SWB	2002 - 2014	9	37216	157,95
Ford Tourneo Custom	long	2012 - 2022	9	37126	157,95	Renault Trafic II	long	2002 - 2014	8	37219	157,95
MB Vito	SWB	1996 - 2003	8	37366	157,95	Renault Trafic II	long	2002 - 2014	9	37221	157,95
MB Vito	SWB	1996 - 2003	9	37367	134,26	Renault Trafic III	SWB	> 2015	8	37222	157,95
MB Vito/Viano	SWB	2004 - 2014	8	37368	157,95	Renault Trafic III	SWB	> 2015	9	37223	157,95
MB Vito/Viano	SWB	2004 - 2014	9	37369	157,95	Renault Trafic III	long	> 2015	8	372000	157,95
MB Vito/Viano	medium	2004 - 2014	8	37114	157,95	Renault Trafic III	long	> 2015	9	372001	157,95
MB Vito/Viano	medium	2004 - 2014	9	37115	157,95	VW Caddy	SWB	2004 - 2020	8	37228	157,95
MB Vito/Viano	long	2004 - 2014	8	37116	157,95	VW Caddy Maxi	long	2004 - 2020	8	37227	157,95
MB Vito/Viano	long	2004 - 2014	9	37117	134,26	VW Caddy 5	SWB	> 2020	8	372281	157,95
MB Vito Tourer/ V-Class	SWB	> 2015	8	37118	157,95	VW Caddy 5 Maxi	long	> 2020	8	372271	157,95
MB Vito Tourer/ V-Class Vanstar/ Campstar (Pössl)	long	> 2015	8	37121	157,95	VW T3	SWB	1979-1990	8	372426	157,95
Nissan NV200	-	2009 - 2021	12	373202	197,-	VW T4	SWB	> 1990	8	372427	157,95
Renault Kangoo	SWB	1997 - 2007	8	37229	157,95	VW T6.1/T6/T5¹	SWB	> 2003	8	372428	157,95
						VW T6.1/T6/T5²	SWB	> 2003	8	372429	157,95
						VW New Multivan	SWB	> 2021	8	372430	157,95
						VW New Multivan	long	> 2021	10	372432	157,95
						VW ID BUZZ	-	> 2023	10	372443	157,95

¹ Panel van, Multivan Startline, California Beach up to 6/2010 w/ hard fiber trim: | ² w/ VW comfort paneling, Caravelle from 2003, Multivan from 2003, Multivan Startline from 7/2010, California from 2003, California Beach from 7/2010

PREMIUM SUCTION CUPS FOR THERMAL MATS

- The premium suction cups are fixed to the thermal mats with the screw function
- Tightening the knurled screw creates a vacuum between the suction cup and the vehicle windshield and ensures a long, secure hold

With tab for easy removal from the windshield.

For eyelets up to max. 15 mm diameter. Ø suction cup: 55 mm.

10 pieces in a set.

37335 8,95



PREMIUM THERMAL MATS BLACKLINE

- 9-ply Isoflex material (PVC)
- Black inside, reflective outside

- Insulation against heat and cold
- The ideal privacy screen

- Attachment with premium suction cups



Premium suction cups included for screwing on.

Driver's cab, 3-piece set (for vehicles with short and long wheelbase)

Vehicle type	YOC.	Item no.	Price
Citroën Spacetourer/Opel Vivaro/Peugeot Expert/Toyota Proace/Pössl Campster/Vanster	>2017	372340	74,95
Fiat Ducato/Citroën Jumper/Peugeot Boxer	1994-2001	372341	74,95
Fiat Ducato/Citroën Jumper/Peugeot Boxer	2002-2005	372342	74,95
Fiat Ducato/Citroën Jumper/Peugeot Boxer	2006-2014	372343	74,95
Fiat Ducato/Citroën Jumper/Peugeot Boxer	>2015	372344	74,95
Ford Transit	2006-2014	372345	74,95
Ford Transit	>2015	372346	74,95
Mercedes-Benz Sprinter	1995-2006	372347	74,95

Vehicle type	YOC.	Item no.	Price
Mercedes-Benz Sprinter	2006-2018	372348	74,95
VW Crafter	2006-2016	372348	74,95
Mercedes-Benz Sprinter	>2018	372349	74,95
VW Crafter	>2016	372355	74,95
Mercedes-Benz Vito/Viano Pössl Campstar/Vanstar	>2016	372350	74,95
Renault Trafic/Opel Vivaro	2002-2014	372351	74,95
Renault Trafic/Opel Vivaro	>2015	372352	74,95
Volkswagen Caddy	2004-2020	372353	74,95
Volkswagen Caddy	>2021	372354	74,95
Volkswagen T4	>1990	372356	74,95
Volkswagen T6.1/T6/T5	>2003	372357	74,95

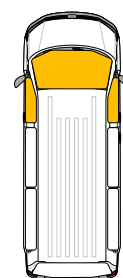

Living room, 4 piece set

Vehicle type	Wheel-base	YOC.	Item no.	Price
Citroën Spacetourer/Opel Vivaro/Peugeot Expert/Toyota Proace/Pössl Campster/Vanster	SWB	>2017	372386	89,-
Ford Transit	SWB	2006-2014	372391	89,-
Ford Transit	SWB	>2015	372392	89,-
Mercedes-Benz Vito/Viano	SWB	>2015	372397	89,-
Renault Trafic/Opel Vivaro	SWB	2002-2014	372398	89,-
Renault Trafic/Opel Vivaro	SWB	>2015	372399	89,-

Vehicle type	Wheel-base	YOC.	Item no.	Price
VW Caddy	SWB	2004-2020	372400	89,-
VW Caddy	SWB	>2021	372401	89,-
VW Caddy Maxi	long	2004-2020	372379	89,-
VW Caddy Maxi	long	>2021	372381	89,-
VW T4	SWB	>1990	372402	89,-
VW T6.1/T6/T5 ¹	SWB	>2003	372403	89,-
VW T6.1/T6/T5 ²	SWB	>2003	372404	89,-

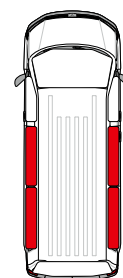

Tailgate/rear door (for vehicles with short and long wheelbase)

Vehicle type	YOC.	Parts	Item no.	Price
Citroën Spacetourer/Opel Vivaro/Peugeot Expert/Toyota Proace	>2017	1	372358	29,95
Fiat Ducato/Citroën Jumper/Peugeot Boxer	1994-2001	2	372360	29,95
Fiat Ducato/Citroën Jumper/Peugeot Boxer	2002-2005	2	372361	29,95
Fiat Ducato/Citroën Jumper/Peugeot Boxer	2006-2014	2	372362	25,46
Fiat Ducato/Citroën Jumper/Peugeot Boxer	>2015	2	372363	25,46
Ford Transit	2006-2014	2	372365	29,95
Ford Transit	>2015	2	372367	29,95

Vehicle type	YOC.	Parts	Item no.	Price
Mercedes-Benz Vito/Viano/ Pössl Campstar/ Vanstar	>2015	1	372372	29,95
Renault Trafic/Opel Vivaro	2002-2014	2	372375	29,95
Renault Trafic/Opel Vivaro	>2015	2	372377	29,95
Volkswagen Caddy	2004-2020	1	372378	29,95
Volkswagen Caddy	>2021	1	372380	29,95
Volkswagen T4	>1990	1	372382	29,95
Volkswagen T6.1/T6/T5 ¹	>2003	1	372384	29,95
Volkswagen T6.1/T6/T5 ²	>2003	2	372385	29,95
Volkswagen T6.1/T6/T5 ²	>2003	1	372383	29,95

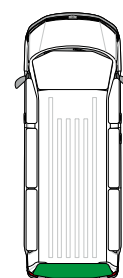

¹ Panel van, Multivan Star, California Beach >06/2010 w. Hard fiber cladding

² Panel van, Multivan, California with comfort paneling

MAGNETIC THERMAL MATS

- 7-layer Isoflex material (PVC)
- Black inside, reflective outside

- Insulation against heat and cold
- The ideal privacy screen

- Attachment via magnets
- For vehicles with short and long wheelbase



372405 / 372406 / 372407
372408 / 372409



Cab, 3-piece set

Vehicle type	YOC.	Item no.	Price
Citroën Spacetourer, Pössl Campster/Vanster	>2017	372359	99,-
Fiat Ducato	1993-2006	372408	99,-
Fiat Ducato	2006	372390	99,-
Ford Transit	>2015	372376	99,-
Mercedes-Benz Sprinter	>2006	372393	99,-
Volkswagen Crafter	2006-2017	372406	99,-
Volkswagen Crafter	>2017	372389	99,-
Mercedes-Benz Vito/V-Class, Pössl Campstar/Vanstar	>2015	372373	99,-
Renault Trafic	2004-2014	372407	99,-
Renault Trafic/Opel Vivaro	>2015	372374	99,-
Volkswagen Caddy	2012-2020	372409	99,-
Volkswagen Caddy	>2021	372364	99,-
Volkswagen T4	1990-2003	372405	99,-
Volkswagen T6.1/T6/T5	>2003	372366	99,-

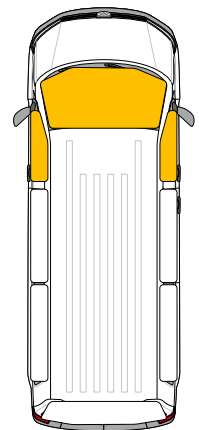

373883

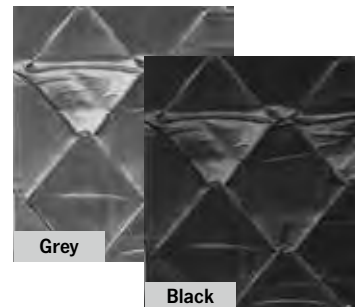

Grey

Black



CanvasInsulation for Volkswagen Transporter, Mercedes-Benz & Pössl Campster pop-top roofs

Protection from extreme heat and cold

With window and ventilation openings

Fastening w. enclosed. Velcro discs and sewn-on Velcro tape*

VW T5/6 swb, super flat roof front high	37396	449,-
VW T5/6 swb, super flat roof rear high	37385	445,-
VW T5/6 swb, EasyFit roof front high <2020	37398	459,-
VW T6 swb, EasyFit roof front high, for high scissors >2021	373981	459,-
VW T5/6 lwb, super flat roof rear + front high	37397	469,-
VW T5/6 California >2003 / California Beach >6/2010	37389	459,-
VW T5/6 lwb, EasyFit roof front high <2020	37388	459,-
VW T6 lwb, EasyFit roof front high, for high scissors >2021	373881	449,-
VW T6 swb, Easyfit roof front extra high	373981	459,-
VW T4 swb, super flat roof front high	37395	415,65
VW T4 California	37399	459,-
MB Vito/Metris/V - Easyfit roof front extra high	373882	439,-
Pössl Campster pop-top roof (>2016)	373883	479,-

*for California + Beach: fastening with insertion straps

Do It Yourself Kit

Make your own thermal mat

Make a template with the enclosed foil, place on the material and cut out. Baste the edges of thermal mat and finish with binding tape. Insert the suction cups, done.

(For inserting the suction cups we recommend eyelet set 14mm item no. 90211)

Scope of delivery: 3.5 m Isoflex material (1.55 m wide), 30 suction cups, 30 m edging tape and 1 plastic film for making your template.

Black/silver	37487	73,95
Grey/silver	37285	73,95

THERMAL BLACKOUT MATS WITH SUCTION CUP ATTACHMENT

- 8 mm thick thermal mats
- UV protection and insulation against heat and cold
- Soft anti-condensation fabric
- Screening for privacy
- Suction cups to screw on for a strong hold
- Colour: inside grey / outside silver



Suction cups inclusive

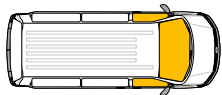

Cab, 3-piece set

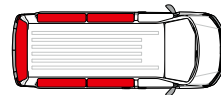

Living room, 5-piece set

Vehicle type	YOC.	Wheelbase	Item no.	Price
Fiat Ducato	1994-2001	SWB + LWB	372745	69,95
Fiat Ducato	2002-2005	SWB + LWB	372746	69,95
Fiat Ducato	2006-2014	SWB + LWB	372747	69,95
Fiat Ducato	>2015	SWB + LWB	372748	69,95
MB Vito/Viano/V-Class Pössl Campstar/Vanstar	>2015	SWB + LWB	372728	69,95
MB Sprinter VW Crafter	2006-2018 2006-2017	SWB + LWB	372716	69,95
Mercedes-Benz Sprinter	>2018	SWB + LWB	372717	69,95
VW Caddy + Caddy Maxi	<2020	SWB + LWB	372719	69,95
VW Caddy 5 Caddy Maxi	>2020	SWB + LWB	372741	73,90
VW T4	1990-2003	-	372713	69,95
VW T5/6/6.1	>2003	SWB + LWB	372710	69,95
VW New Multivan	>2021	SWB + LWB	372720	75,70
VW ID.BUZZ	>2022	-	372725	75,70
VW Crafter	>2017	SWB + LWB	372718	69,95

Vehicle type	YOC.	Wheelbase	Item no.	Price
MB Vito/Viano/V-Class, Pössl Campstar/Vanstar	>2015	long	372729	115,-
VW Caddy	<2020	SWB	372749	119,-
VW Caddy Maxi	<2020	long	372750	119,-
VW Caddy 5	>2020	SWB	372742	119,-
VW Caddy 5 Maxi	>2020	long	372744	123,95
VW T4	1990-2003	SWB	372714	119,-
VW T4	1990-2003	long	372715	119,-
VW T5/6/6.1	>2003	SWB	372711	119,-
VW T5/6/6.1	>2003	long	372712	122,-
VW New Multivan	>2021	SWB	372721	121,-
VW New Multivan	>2021	long	372722	123,-
VW ID.BUZZ	>2022	-	372726	119,-



Picture shows darkening in VW Caddy

Blackout set with magnetic attachment

- 8-piece (living area + driver's cab)
- Blackout fabric, absolutely opaque
- Washable
- Material: 100% PES
- Minimum pack size

For VW Caddy 5 Maxi / Ford Connect 3 L2 > 7/2022	372272	149,-
For VW T7 Multivan, L2	372273	179,-



Dashboard cover Fiat Ducato

Perfect insulation in the cab area, including foot area, 8mm thick, including packing bag, easy installation.

2002 - 2006	37432	132,-
2006 - 2014	37433	132,-
> 2015	37434	132,-

VEHICLE EXTERIOR INSULATION

Outdoor thermal cover

- 3-layer insulated PVC material with UV protection and water resistance
- 10 mm thick insulating foam

Luxurious window cover for the cab window. Also covers the side windows. Is hung on the side doors. A viewing window is closed with Velcro and can be opened if required. Delivery Includes packing bag.

Vehicle type	YOC.	Item no.	Price
Citroën Spacetourer Campster/ Vanster (Pössl)	> 16	37460	149,-
Fiat Ducato	94 - 02	37438	149,-
Fiat Ducato	02 - 06	37435	149,-
Fiat Ducato	06 - 14	37436	149,-
Fiat Ducato	> 15	37437	149,-
Ford Transit	07 - 14	37442	149,-
Ford Transit	> 15	37443	149,-
Mercedes-Benz Vito/ Campstar/Vanstar Pössl	> 15	37497	149,-
Mercedes-Benz Sprinter	06 - 14	37444	149,-
Mercedes-Benz Sprinter	> 15	37445	149,-
Renault Trafic	> 2015	37496	149,-
Renault Master	08 - 10	37446	149,-
Renault Master	10 - 14	37447	149,-
Renault Master	> 15	37448	149,-
Volkswagen Caddy 5	> 2021	37494	149,-
Volkswagen New Multivan	> 2021	37495	149,-
Volkswagen Transporter 4	90 - 03	37449	149,-
Volkswagen Transporter 5	06 - 15	37450	149,-
Volkswagen Transporter 6	> 15	37451	149,-



Outdoor insulation mat with X-Trem insulation

- The cab windows remain free of snow, ice and fogging
- 3-layer insulated PVC material
- Additional 7 mm thick insulation foam
- Connection of the driver's compartment and hood with Velcro

Vehicle type	YOC.	Item no. Cab win- dows	Price	Item no. Hood & Doors	Price
Fiat Ducato Citroën Jumper Peugeot Boxer	94-01	37371	109,-	373710	96,90
	02-05	374351	109,-	374350	114,-
	06-14	37372	109,-	373720	96,90
	> 15	373700	109,-	3737000	114,-
Ford Transit Custom Tourneo Custom	12-22	374420	109,-	3744200	96,90
Ford Transit	86-99	-	-	3744320	96,90
Ford Transit	06-14	374423	109,-	374422	96,90
Ford Transit	> 14	374434	109,-	3744300	114,-
Iveco Daily	00-06	372300	109,-	3723000	96,90
Iveco Daily	06-14	372301	109,-	3723010	96,90
Iveco Daily	> 15	372302	109,-	3723020	114,-
Mercedes-Benz Sprinter	96-06	37268	109,-	372682	114,-
Mercedes-Benz Sprinter	06-14	372680	109,-	3726800	114,-
Mercedes-Benz Sprinter	> 15	372681	109,-	3726810	114,-
Renault Master	05-10	374430	109,-	3744301	114,-
Renault Master	> 11	374431	109,-	3744310	96,90
Volkswagen T4	90-03	374491	109,-	374490	114,-
VW T5	06-15	374501	109,-	374500	96,90
VW T6	> 15	374511	109,-	374510	114,-

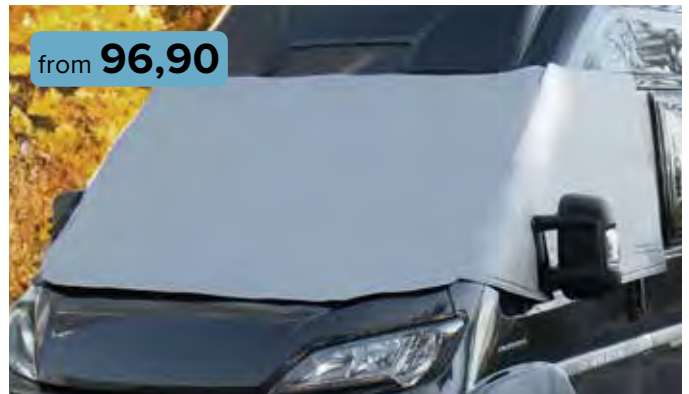

VEHICLE EXTERIOR INSULATION



X-Trem Jacket External insulation for Fiat Ducato, Peugeot Boxer, Citroën Jumper

- Excellent insulating properties
- Easy to roll up and store
- Optimal fixation due to elastic straps
- Front ventilation slits are also covered
- Integrated magnets provide additional support
- Moisture-resistant thermal padding
- With transport bag

① All-Year All Season

All year cover with excellent insulation

2007-2014	90797	275,-
> 2014	907971	279,-

② Lahti winter

Extra thick padded outer insulation. Tested in Scandinavia and Lapland. Ideal thermal insulation for the winter vacations.

2007-2014	90798	329,-
> 2014	907981	329,-



X-Trem Comfort - Exterior insulation for Fiat Ducato, Peugeot Boxer, Citroën Jumper

Window/door insulation

for insulating the windows, side doors and ventilation slots. Window on the windshield can be folded down (so you can enjoy the sun).

Attachable hood cover

Can be additionally attached. Protects engine compartment from cold penetration & additionally insulates interior.

2-piece set consisting of windshield/door insulation and snap-on hood cover

2007-2014	90796	439,-
> 2014	907961	439,-



Covertch Insulating mats for cab and hood

- Eight layers, the outer ones made of PVC
- UV-resistant
- Incl. Faux leather pannier
- Water repellent
- Perfectly suitable for low temperatures
- Very soft, thus perfect vehicle adaptation
- Secure fastening with Velcro



Vehicle type	YOC.	Item no. Cab win- dows	Price	Item no. Hood & Doors	Price
Fiat Ducato 230	94-01	90918	272,-	90927	272,-
Fiat Ducato 244	02-05	90919	272,-	90928	272,-
Fiat Ducato 250	06-15	90920	272,-	90929	277,-
Fiat Ducato	from 15	909200	272,-	909291	277,-
Ford Transit	06-14	90921	272,-	90930	277,-
Renault Master	05-10	90923	231,20	90932	277,-
Renault Master	> 11	909231	272,-	909321	235,45
Volkswagen T4	> 90	90925	231,20	-	-
Volkswagen T5/6	> 03	90926	231,20	-	-

VEHICLE EXTERIOR INSULATION

Coverttech Insulating mats for fully integrated vehicles

- Eight layers, the outer ones made of PVC
- Ideal thermal insulation in winter
- Prevents condensation from forming on the windows
- Incl. Faux leather pannier
- Water-repellent, UV-resistant
- Perfectly suitable for low temperatures
- Very soft, thus perfect vehicle adaptation



Vehicle type	YOC.	Item no.	Price
Carthago C-Line	> 2012	90911	369,-
Carthago S-Plus/Highliner	< 2012	90912	369,-



Fastening with suction cups



Climate protection hood for pop-top roofs front high Climacover weather protection cover for VW T5/T6 > 2003, Mercedes-Benz Vito/Metris & Pössl Campster

Ideal protection against rain, snow, ice and dirt.
With windows and vents.
Mounting over the complete roof.

For short wheelbase, Easy Fit roof and California:

Normal scissor < 2020	37391	499,-
High scissor > 2021	373941	559,-

Short wheelbase, super-flat pop-top roof	37393	479,-
Short wheelbase, SCA 194 pop-top roof	37360	519,-
Long wheelbase, Easy Fit roof, < 2020	37394	559,-
Long wheelbase, Easyfit high front	373940	499,-
Mercedes-Benz Vito/Metris/V-Easyfit - high scissors	373942	559,-
Pössl Campster pop-top roof SCA 260 (>2016)	373943	559,-



Tire cover

- 3-layer insulating material
- Complete cover
- 2 eyelets for mounting

Colour: silver. Weight: 0.4 kg.
90494 10,16



Thermal cover for gas bottles

- Protection from cold and direct sunlight
- 3 layers
- with velcro



- | | | |
|-----------------------|-------|-------|
| ① For 5kg gas bottle | 75480 | 25,90 |
| ② For 11kg gas bottle | 75481 | 27,90 |



MOSQUITO NETS FOR MINIVANS / VOLKSWAGEN VANS



Mosquito nets for VW Caddy & Citroën Spacetourer

- Easy attachment w/ elastic band or magnets
- Fine mesh flexible insect screen net
- No modification to the vehicle necessary
- Center door opening
- Zipper opening operable from inside & outside

For right or left sliding door w/ & without glazing. Easy to attach thanks to the integrated elastic band or magnets. The tailgate net with 2 zippers can be rolled up & fixed. Net closes reliably at the bottom of the sill w/ a lead tape.

For Volkswagen Caddy

2003-2020 (short wheelbase) 2008-2020 (long wheelbase)		
Sliding door opening (w/ elastic band)	46283	179,-
Rear door (with elastic band)	46284	179,-

Caddy Maxi 5 > 2021 (also suitable for Ford Connect 3)

Sliding door opening (with magnets)	461336	219,-
Rear door (darkening with elastic band)	461335	244,-

For Citroën Spacetourer/Jumper & identical vehicle types

Peugeot Traveller/Expert, Toyota Proace Verso (> 2016), Opel Zafira Life/Vivaro C (> 2019)

Sliding door opening (with magnets)	461334	185,50
Rear door (with elastic band)	461333	219,-



VW Caddy



Citroën Spacetourer

Mosquito nets for sliding doors, rear doors/flaps & driver's cab for Volkswagen Transporter

- Fastening with elastic band or Velcro tape and press studs, depending on type
- Close-meshed mosquito net
- UV resistant polyester fabric
- Flexible and soft drape
- With zipper and lead tape



The mosquito net is stretched around tailgate or sliding door seal using a rubber cord or Velcro fastener or press studs & is tightly fitted at the bottom w/ lead tape. A large door with two-way zipper allows passage from the inside and outside without removing the net. The tailgate/sliding door can be closed easily. For the ride we recommend to remove the net.



①



②



③



③

For Volkswagen T5/T6

Station wagon box, Startline < 2010 and California Beach without comfort trim

① Sliding door opening (with Velcro tape)	461351	173,-
---	---------------	--------------

Multivan, Caravelle and Startline > 2010 with comfort trim

① Sliding door opening (w/ Velcro strip)	461350	189,-
--	---------------	--------------

California and California Beach > 2010 with comfort trim

① Sliding door opening (with Velcro strip)	461353	196,-
--	---------------	--------------

> 2003 Estate, panel van, Multivan, California/California Beach, Caravelle with and without pop-up roof.

② Tailgate (w/ elastic band)	461331	196,-
③ Tailgate (with Velcro tape)	46135	159,-

For Volkswagen T4 (w/o illustration)

< 2003

Sliding door opening (with Velcro strip)	46132	144,95
--	--------------	---------------

Station wagon and panel van

Rear door (with Velcro strip)	46133	164,-
-------------------------------	--------------	--------------

For Volkswagen T3 (w/o illustration)

1980-1989

Sliding door opening (with Velcro strip)	46130	159,-
--	--------------	--------------

MOSQUITO NETS FOR BUSES



Premium mosquito net for Volkswagen T5/T6 sliding door (right) & tailgate

- Fastening with Velcro tape under rubber seal
- Velcro tape can remain permanently under rubber seal on vehicle
- Made from high-quality, robust & dense canvas fabric
- UV-resistant
- Roll-up and wide door
- Sliding door w/ magnetic catch for quick entry and exit



For Volkswagen T5/T6

Sliding door opening	461360	179,90
Tailgate	461361	179,90

Insect screen for sliding and rear doors

- Held in place by Velcro tape and press studs/ magnets or elastic band
- Close-meshed mosquito net
- UV resistant polyester fabric
- Flexible and soft falling
- Center zipper can be operated from the inside and outside
- Bottom lead tape
- Mounting material included with all nets

For Mercedes-Benz Vito and Viano

Mercedes-Benz Vito < 2003 Sliding door opening (with Velcro tape)	46139	169,50
Rear door (with Velcro)	46142	214,-

Mercedes-Benz Vito/Viano 2004 - 2014 slidingdoor opening (with hook-and-loop tape)	46140	169,50
Rear door (with Velcro)	461401	169,50

Mercedes-Benz Vito/Viano > 2014

① Slidingdoor opening (with hook-and-loop tape)	461402	169,50
Rear door (with Velcro)	461403	169,50
② Rear door (Darkening with elastic band)	461332	278,-



Fig. shows Ford Transit Custom

For Ford Transit/Ford Transit Custom

Fastening with Velcro tape.

Ford Transit 2000-6/2012

Sliding door	46451	179,-
Tailgate	46136	224,-

Ford Transit Custom > 2007/2012

③ Sliding door	461404	169,50
Tailgate	461405	169,50

For Renault Trafic, Opel Vivaro, Nissan NV300

Fastening with Velcro tape.

Sliding door opening 2007-2013	461411	179,-
④ Sliding door opening > 2014	461412	169,50
Rear door > 2014	461413	179,-

MOSQUITO NETS FOR VANS



Mosquito nets for Fiat Ducato, Peugeot Boxer, Citroën Jumper

- Fastening with Velcro tape on side and top, additional support w/ snaps
- Tight mosquito net against even the smallest insects
- UV stable and flexible polyester fabric
- Flame retardant
- Durable and high quality
- Good visibility and air circulation
- Zippers to operate from inside and outside
- Lead tape for weighting at the bottom
- Soft fall and dark colour
- High quality, no snagging with velcro tape

Mosquito net for the sliding door or rear wing door w/ convenient zipper entrance.

Scope of delivery: Black mosquito net and mounting hardware (snaps, velcro)

For model years > 2007

Suitable for roof height H2 & H3 (stand. high roof), Vehicle length 541 cm, 599 cm and 636 cm and Sliding door dims.: H 1755 x W 1250 mm

Adapted for vehicles w/ kitchen parts protruding into sliding door cut-out. With practical J-shape zipper.

① Front entry **464522** **189,-**

Suitable for large-capacity box or Adria Twin 640 SHX e.g.

② Rear entry **464520** **184,-**

Mosquito net for rear door, standard high roof > 2007 Door height: 1760 mm (without illustration) Center entry

46452 **184,-**

Suitable for roof height H 1 (flat roof) Vehicle length: 496 cm & sliding door dims.: H 1480 mm x W 1075 mm

③ Front access **46240** **199,-**

For rear wing doors: H 1790 mm

suitable for roof height H2 (high roof) (not shown) Center entry

464521 **184,-**

④ **For rear door: H1 (flat roof) w/ 2-way zipper**, allows only upper part of net to be opened. **461730** **199,-**

For years of construction 1994 - 2006

Suitable for roof height H2 and H3 (high roof) Mosquito net for sliding door opening. With center zipper

⑤ Central access **46435** **172,-**

For Mercedes-Benz Sprinter / Volkswagen Crafter

Fine-mesh insect screen net w/ 2-way zipper. Reliable fastening w/ elastic, magnet or Velcro tape on body panel, sealing at the bottom w/ lead tape. Rear doors can be closed with net. For the ride we recommend to remove the net.

Mercedes-Benz Sprinter 1996-2006 Roof height H1

(not suitable for standard high roof)

Sliding door opening (with Velcro tape) **46143** **169,-**

Mercedes-Benz Sprinter/Crafter >2007 roof height H1 from L2 (from vehicle length 5261 mm) (not suitable for standard high roof)

Sliding door opening (with Velcro strip) **46450** **189,-**

Rear door (with Velcro) **464501** **189,-**

Mercedes-Benz Sprinter with standard high roof (H3), >2006 and Volkswagen Crafter with standard high roof (H3) 2006 - 2016

Sliding door right (with magnet) **464524** **214,-**

Rear doors (with elastic band) **461736** **299,-**

Volkswagen Crafter > 2017 with high roof H3 and H4

Rear door (w/ elastic band) **464502** **220,-**

Sliding door on the right (with magnet) **464523** **214,-**

MOSQUITO NETS WITH MAGNETIC ATTACHMENT



- Very simple & quick attachment w/ magnets
- UV resistant polyester fabric
- Mosquito nets for sliding doors suitable for Driver's side and passenger's side

- Zipper on both sides for opening from the inside & outside (mosquito net for sliding door & rear door)
- No modifications to vehicle necessary
- No additional tools required
- Scope of delivery mosquito nets cab windows: 2 pcs.



Cab window (2 mosquito nets included)



Sliding door



Tailgate



Vehicle type	YOC.	Mounting	Item no.	Price	Opel Movano	>2010	Cab window	461323	64,90		
Citroën Dispatch/Jumpy/Spacetourer	>2017	Cab window	461301	64,90	Renault Master	2010-2020	Sliding door	461324	129,-		
		Sliding door	461302	129,-			Tailgate	461325	129,-		
Peugeot Expert/Traveler	>2022	Tailgate	461303	129,-	Opel Vivaro	2014-2019	Cab window	461326	64,90		
Toyota Proace/Proace Verso					Sliding door	461327	129,-	Renault Trafic	>2014	Tailgate	461328
Fiat Scudo/Ulysse	>2019				Volkswagen Crafter	>2017	Cab window	461341	64,90		
Opel Vivaro/Zafira Life	>2006	Cab window	461304	64,90	Volkswagen Caddy (short + long wheelbase)	2003-2020	Sliding door	461342	129,-		
Citroën Jumper Fiat Ducato	Sliding door (H2/H3)	Tailgate (H2)	461305	129,-			Cab window	461329	64,90		
		Tailgate (H2)	461306	129,-			Sliding door	461330	129,-		
Peugeot Boxer	2012-2022	Cab window	461307	64,90	Volkswagen Caddy V	>2021	Sliding door (kR)	461338	64,90		
Ford Tourneo Custom/Transit Custom	>2014	Sliding door	461308	129,-	Volkswagen T4 Caravelle/T4 Multivan/T4 Transporter	1990-2003	Sliding door (IR)	461339	129,-		
		Tailgate	461309	129,-			Tailgate	461340	129,-		
		Cab window	461310	64,90			Cab window	461344	64,90		
Ford Transit H1	>2018	Sliding door	461312	129,-	Volkswagen T5 Caravelle/T5 Multivan/T5 Transporter	2003-2015	Sliding door	461348	129,-		
		Tailgate	461313	129,-			Tailgate	461349	129,-		
		Cab window	461314	64,90			Sliding door	461363	64,90		
Mercedes-Benz Sprinter	2006-2017	Sliding door (H2/H3)	461315	129,-	Volkswagen T6 Caravelle/T6 Multivan/T6 Transporter	>2015	Tailgate	461364	129,-		
Volkswagen Crafter	>2014	Tailgate (H2/H3)	461316	129,-	Volkswagen New Multivan	>2022	Tailgate	461365	129,-		
Mercedes-Benz Sprinter	2003-2014	Cab window	461317	64,90	Volkswagen ID.BUZZ	>2023	Cab window	461366	129,-		
		Sliding door	461318	129,-			Sliding door	461367	129,-		
		Tailgate	461319	129,-			Tailgate	461368	129,-		
Mercedes-Benz Viano/Vito	>2014	Sliding door	461320	64,90							
Mercedes-Benz Vito		Tailgate	461321	129,-							
			461322	129,-							

PRIVACY AND INSECT CURTAINS



Extra dense chenille fleece curtains

- Narrow fleece tapes, therefore higher density
- Even better protection against insects & draughts
- Even better protection from prying eyes

The loop tapes of the new loop curtains from CARBEST have a narrow diameter of 26 mm per strand. Due to higher density, they provide better protection against insects & draughts. They also ensure pleasant level of privacy & reliably prevent people from looking into vehicle.

Size W 56 x H 185 Black / grey	912641	24,95
White / Grey (not shown)	912642	24,95
Size W 56 x H 205 Black / grey	912643	29,95
White / Grey (not shown)	912644	29,95

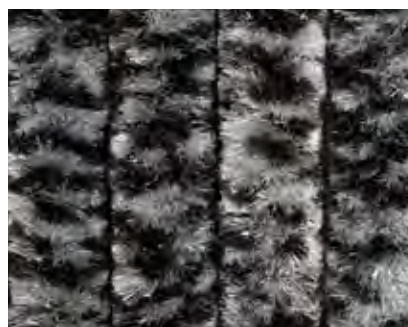

Illustration shows colour black / grey



AUTOLIFT

FULLY AUTOMATIC LEVELING SYSTEM PERFECT ALIGNMENT OF THE VEHICLE FOR UNEVEN TERRAIN

12V

MAX. 5 t
SUPPORT
LOAD

INCL.
REMOTE
CONTROL

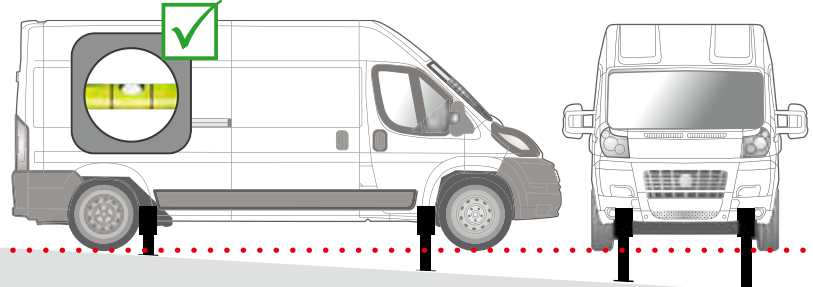

Cockpit control panel



Radio remote control

Fully automatic Leveling system.
Perfect alignment of vehicle on uneven terrain.

12V

MAX. 5 t
SUPPORT
LOAD

INCL.
REMOTE
CONTROL

- Fully automatic leveling of vehicle
- For vehicles up to 5 tons, up to 2 tons/support
- 12 V power supply via on-board network
- Operation via cockpit control panel or by radio remote control
- Support base length 300 mm, extendable to 420 mm
- Load cap. per support 2000 kg
- Emergency operation if power failure
- Waterproof motors & connections

Technical data:

Load cap. per support 2000 kg, total support load 5000 kg, support base length 300 mm - extendable up to 420 mm, ground clearance necessary. Consumption in operation app. 16/18 A.

Car lift w/ 4 lifting supports Weight app. 50 kg
465100 2489,-

Adapter complete set for Fiat Ducato & identical vehicles

Weight app. 13 kg

Fiat Ducato X244, 2000-2006	465104	259,-
Fiat Ducato X244 Alko, 2000-2006	465105	259,-
Fiat Ducato X250/290, 2007-2014	465102	259,-
Fiat Ducato X250/290 Alko, 2007-2014	465103	259,-
Fiat Ducato X290 > 2015	465113	259,-
Fiat Ducato X290 Alko > 2015	465112	259,-
Fiat Ducato X290 > 2015 (with spare tire below and tank in front of the rear axle)	465116	255,-

Complete adapter set for Ford Ford Transit > 2014,

Weight approx. 10 kg

465107 259,-

Complete adapter set for Mercedes-Benz/Iveco/Renault

Weight approx. 12.5 kg

Mercedes-Benz Sprinter > 2018	465110	259,-
Iveco Daily > 2000	465108	259,-
Renault Master 3 > 2011	465109	259,-

Universal-Adapter rear 465111 146,-

AIR SUSPENSION SYSTEMS FOR FIAT DUCATO/ PEUGEOT BOXER/CITROËN JUMPER/OPEL MOVANO

CARBEST  by ESI

With immediate effect on load assessment

Basic and Premium air suspension system for Fiat Ducato/
Peugeot Boxer and Citroën Jumper > 2014, also for
Ducato 8 (> 09/2021) and for Opel Movano > 2021

- 2-circuit system w/ compressor & separately adjustable air bellows
- Significant increase in ride comfort
- Increased lateral stability & better roadholding
- Custom-fit control element for Fiat Ducato
- Mounting takes place on rear axle

Air spring system w/ 2-circuit system w/ separately fillable air bellows. Air pressure is individually adjustable per side. Allows wheel load differences to be quickly detected & compensated for. With help of the two pressure gauges in the interior, air pressure can be monitored. This not only increases your driving comfort, but also significantly increases safety while driving. Even with a heavier load, your motorhome can be steered safely & comfortably - thanks to higher suspension travel & less side tilt. Air pressure is controlled via special Ducato control unit. System is only suitable for models without electronic handbrake.

Scope of delivery: Auxiliary air springs left & right w/ vehicle specific connectors, vehicle specific control panel w/ safety valves, 2 pressure gauges & switches, 12V compressor kit, Rilsan pipes, small hardware set for installation, specific & detailed installation instructions w/ illustrations for each step.

Basic 6" air suspension system



2-circuit system w/ central filling of both air bellows & subsequent independent reduction of air pressure in left and right air bellows. Recommended for vans or motorhomes w/ wheelbase 300 cm & 345 cm w/o motorcycle carrier.

467631 665,-

Air suspension system Basic 8"



2-circuit system w/ central filling of both air bellows & subsequent independent reduction of air pressure in left and right air bellows. Recommended for motorhomes w/ wheelbase 345 cm & 403 cm. Also for vehicles w/ rear garage or rear/motorcycle carrier & for heavier loads.

467632 815,-

Air suspension system Premium 7.3"



2-circuit system w/ individually adjustable filling of individual air bags & independent adjustment of left & right sides. Recommended for motorhomes w/ wheelbase 300 cm & 345 cm w/ rear garages or rear carrier. Also suitable for wheelbase 403 cm w/ low load.

467630 1146,-

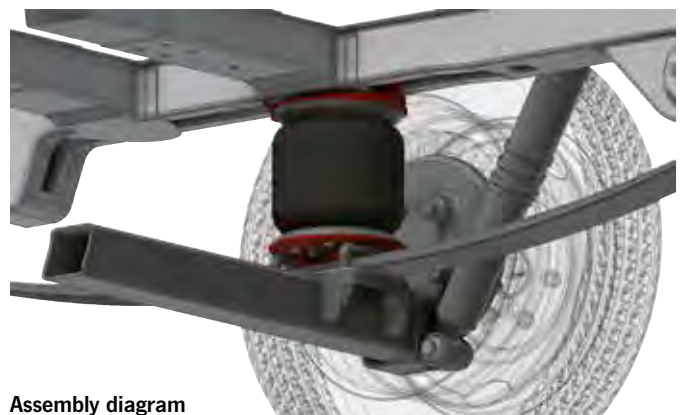

Assembly diagram

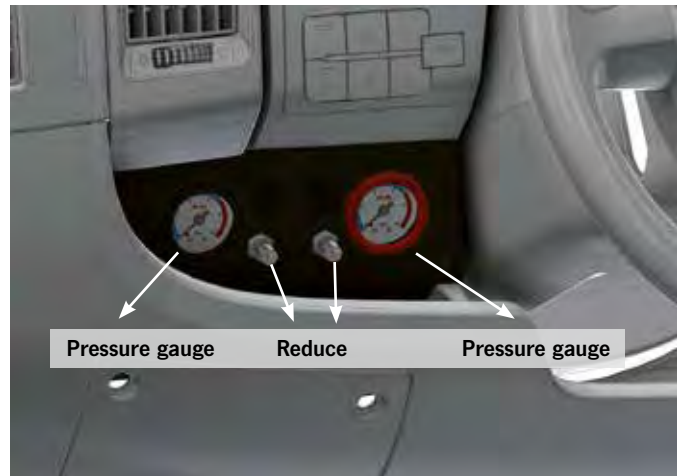

Pressure gauge Reduce Pressure gauge

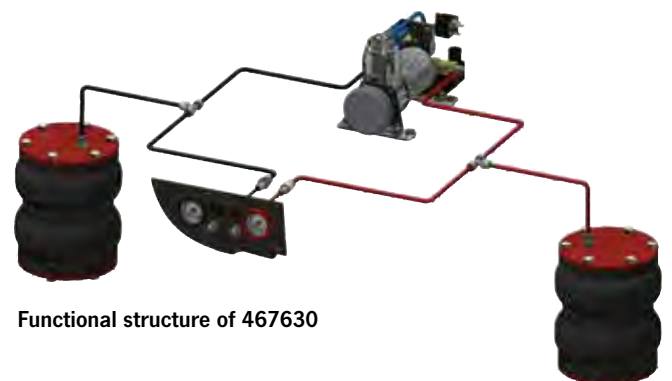

Functional structure of 467630

We recommend installation by a specialist workshop:
www.reimo.com/haendlersuche/

CARAMOVE

CARAVAN MANEUVERING SYSTEMS

Cara-Move II - fully automatic caravan shunting system



7 years
Parts warranty



- Automatic engagement drive
 - Move the caravan effortlessly, up to 2250 kg
 - Lightweight due to plastic cover
 - Easy and stress-free maneuvering with the Smart Handset
 - Suitable for single and double axle caravans with two axles
- 4 motors are required for all-wheel drive (2x 920209)

Smart Handset & Control System

Simple and intuitive operation. Precise maneuvering due to the unique roller-ball design. Variable speed control and 360° fluid movement, So you really effortlessly control your caravan.

Speed: 12 cm/sec, Operating voltage: 12 V DC Weight (2 motors): 23 kg, Combined weight (incl. installation kit etc.): approx. 34 kg

Max. Climbing capacity according to total weight:
15% - 2500 kg / 20% - 2250 kg / 25% - 2000 kg

Scope of delivery: 2 motors, mounting bracket, remote control, battery disconnect switch (100 A), rocker arm, mounting hardware, operating instructions

920209 1449,-

Cara-Move - powerful, semi-automatic shunting system



7 years
Parts warranty

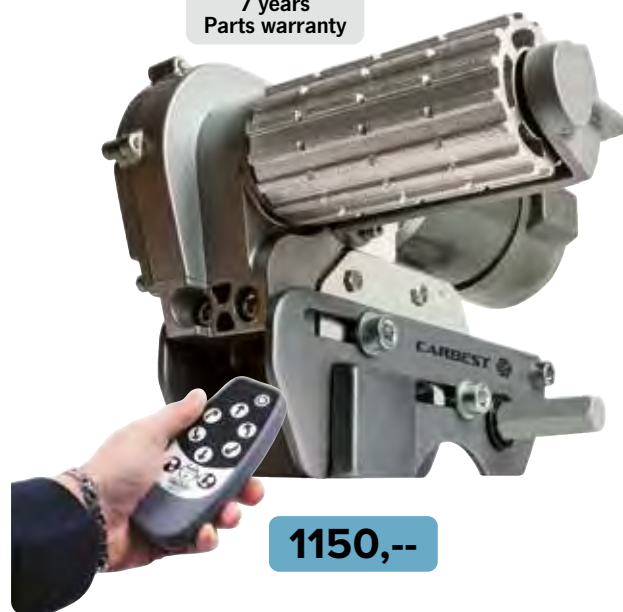

- Soft start precision control
- Compact, stable, reliable
- Suitable for single and double-axle caravans with two axles,
- 4 motors are required for all-wheel drive (2x 920208)
- Convenient control with remote control

The manual caravan maneuvering aid moves single and double axles up to a maximum total weight of 2250 kg. The aluminum drive roller is swiveled on and off manually.

Current consumption on level ground: app. 25 A. Max. Current consump.

(1100 kg caravan single-axle, slope 25%): 80 A, Weight: 35 kg

Max. Climbing capacity according to total weight:

15% - 2500 kg

20% - 2250 kg

25% - 2000 kg

Scope of delivery: 2 motors, mounting bracket, remote control, battery disconnect switch (100 A), rocker arm, mounting hardware, operating instructions

920208 1150,-

In some countries, the installation must be checked by a professional technician to comply with local regulations.

Optional fitting adapters

Low profile housing adapter plates

If your chassis frame height is less than 140 mm, these plates must be installed to lower assembly to the correct height of 185 mm. **Pair** **E6205** **36,-**

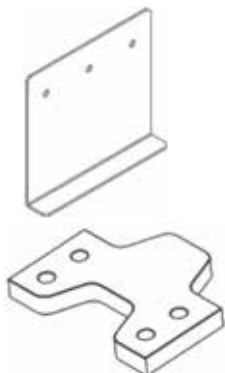

16 mm spacers

Use spacers to lower the maneuvering aid assembly if your chassis has a frame height between 140 and 185 mm. **Pair** **E6204** **40,50**

Narrow gauge chassis adapter

These plates must be used if you have an AL-KO Vario III/AV chassis that has a frame thickness of less than 2.8 mm. **Pair** **E6206** **36,-**

Set of 8 screws M 10 x 100

Set of 8 extended clamping bolts for use with 16 mm spacers (E6204). **E6207** **12,95**



TRAILER ELECTRICS



Mini short adapter

From 13 to 7 poles. Very compact version for cars with 13-pin socket and trailers with 7-pin plug.

82137 9,95



Plug 7 pin Plastic housing

To towing vehicle.

82100 3,95



Plug 7 pin Steel housing

82132 3,95



Plug 13 pin With locking device.

Contacts nickel plated

82106 8,95



Short adapter

From 7-pin or Multicon socket on the towing vehicle to 13-pin plug on the trailer.

82107 9,95



Trailer socket

7-pole
Steel housing
821321 3,95



Trailer socket

7-pole
Plastic housing
821022 3,95



Trailer socket

13-pole
With switching off the rear fog light on the car.

82105 8,95



Short adapter

From 13-pin socket on the towing vehicle to 7-pin Plug on the trailer.

82108 7,95



Coupling

13-pole
For extension cable with 13 connection poles

82113 9,95



Adapter cable

Socket to plug
Cable 30cm long:
7-pin socket to 13-pin plug
821324 12,71



Assignment of 7- and 13-pin connectors

13-pin 12 V plug-in system for cars and trailers.

Vehicles with towing device are equipped with a 13-pin socket equipped. Rear fog light has been mandatory for trailers since 1.1.1991. The last free pole of the previous 7-pin connector is occupied. (Continuous current in the vehicle is no longer possible.)

Additional connection options of the 13-pin plug connection: reversing lights, continuous power for caravan, charging line for an additional battery or for lights in the trailer, etc.

Adaptations: allow any combination between 7- and 13-pin equipped vehicles and trailers. The fixing points are identical for 7-pin and 13-pin connectors.

Safe in function by:

High-quality contacts with surface finish, bayonet locking, Long service life, as temperature resistant from +100° to -40°C. Dust and waterproof.

Standard 7-pin.



Standard 13-pin. (Hunter system)



13-pin. Multicon (WeSt)



no longer usual

7-pin. 13-pin.

No.	DIN	No.	DIN	Consumer	Colour	Cable Ø
1	L	1	L	Turn signal left	Yellow	1,5
2	54G	2	54G	Fog lamp	Blue	1,5
3*	31	3*	31	Ground (7 pin) Ground 1-8 (13 pin)	White	2,5
4	R	4	R	Turn signal right	Green	1,5
5	58R	5	58R	Taillight re.	Brown	1,5
6	54	6	54	Brake light	Red	1,5
7	58L	7	58L	Taillight li.	Black	1,5
		8	ZR	Reversing light	Grey	1,5
		9	30	Continuous positive (+)	Brown/Blue	2,5
		10		Charging line (+)	Brown/Red	2,5
		11		not allocated		1,5
		12		not allocated		1,5
		13*	31	Ground Pole 9-12	Black/White	2,5

*The ground lines must not be connected conductively.

*The 13-pin Multicon world plug (WeSt) also fits into 7-pin junction boxes, but not in today's, 13-pin sockets (Jäger system).

PROFI CEE CABLE DRUM / CEE CABLE



Our accessory tip:
 Cable transport bag **820292**
 Cable tie with handle **820091**
 Hand cable drum

- ① **CEE cable drum** 3 pole CEE plug (on the drum) & CEE coupler (on the short end). Campsite approval up to 25 m. 16 A, H07 RN-F 3 x 2.5 mm². 25 m **820481 99,-**
- ② **CEE cable drum** H07 RN-F 3 x 2.5 mm². 2 Schuko/1 CEE socket, thermal protection switch. 25 m **82027 119,-**
- ③ **CEE cable drum** 3 pole CEE plug (on the drum) and CEE angle coupling and Schuko coupling (on the short end). Campsite approval up to 25 m. 16 A, H07 RN-F 3 x 2.5 mm². 25 m **820483 109,-**



CEE extension cable

Neoprene rubber cable. Incl. transport bag. Suitable for outdoor use. Incl. Carrier bag H07RN-F, 3 x 2.5 mm²

10 m	82018	59,95
25 m	820181	89,95
H07RN-F, 3 x 1.5 mm ² (Not permitted for camping in Germany!)		
10 m	82024	29,95
25 m	820242	57,95
40 m (without bag)	820244	59,42



Adapter Schuko/CEE

Schuko plug/CEE coupling, H07RN-F 3 x 2,5 mm², incl. carrying bag

0,4 m*	820211	12,95
1,5 m*	82021	16,95
4,0 m*	820212	19,95
25 m*	820213	79,95
5H07 RN-F 3 x 1.5 mm ² (Not approved for camping sites in Germany!)		
0,4 m	8202110	7,90

*also suitable for France



Adapter CEE/Schuko

CEE plug / Schuko rubber coupling H07RN-F 3 x 2.5 mm² incl. Carrier bag

1,5 m	82022	12,95
0,4 m	820221	9,95
H07 RN-F 3 x 1.5 mm ² , 0,4 m (Not permitted for camping in Germany!)		
	820261	8,95



3-fold socket strip

With three Schuko sockets and cover caps, 10 m connection cable + CEE plug, automatic circuit breaker fused with 25 A. In plastic housing with suspension device. 2 clamps Ø 21 mm for attaching-clips to tent poles. 3 x 1.5 mm² (Not approved for camping in Germany!)

10 m	82210	59,95
------	--------------	--------------

Fig. shows 1.5 m cable



Adapter Schuko / Angle

Schuko plug/CEE angle coupling w/ additional Schuko socket. Prevents kinking of the cable. H07 RN-F 3 x 2.5 mm².

1,5 m	82020	15,50
25 m	820201	84,95
H07 RN-F 3 x 1.5 mm ² (Not approved for camping sites in Germany!)		
	82025	12,99



CEE plug/angle coupling

With additional Schuko socket. 3 x 2,5 mm²

1,5 m	82036	21,95
15 m	820362	54,95
25 m	820361	85,95

With additional Schuko socket. 3 x 1.5 mm² (Not approved for camping in Germany!)

20 m	82204	39,95
30 m	822041	44,90



CEE connection cable

CEE plug/coupling, 3 x 2.5 mm, length: 1.5 m.

	82035	16,95
--	--------------	--------------



3-fold socket strip

With three Schuko sockets and cover caps, 10 m connection cable with CEE plug. Plastic housing. H07 RN-F 3 x 2.5 mm².

10 m	82208	34,90
As 82208 but with 3 x 1.5 mm ² (Not approved for camping sites in Germany!)		
1,5 m	82209	11,36
5 m	822091	15,94

CEE PLUGS AND CABLES FOR PROFESSIONAL USE



CEE angle plug

For a kink-free connection to the power column or socket.

820302 6,95



CEE coupling

Suitable for connection to CEE input sockets.

82032 4,95



CEE plug

Suitable for CEE junction box on campsites and CEE couplings

82031 5,20



Adapter CEE/Schuko

CEE coupling with cover

82007 9,50



CEE angle coupling

CEE 17 European coupling with integrated Schuko socket and hinged cover, suitable for CEE input sockets.

82030 7,95



2-fold distributor

CEE plug/2-way CEE distribution socket with hinged cover

82301 13,95



Adapter CEE/Schuko

CEE plug / earthed coupling with cover.

82044 15,95



Plug GB

to CEE coupling, H=7RN-F Cable 3 x 2.5 mm². App. 20 A.

0,4 m 821543 8,30
1,5 m 821546 7,57



CEE surface-mounted power plug

Ideal for concealed installation in engine compartment (e.g. on T5) with cover 3-pole 230 V / 16 A.

82008 13,90



CEE Safebox

To protect against moisture. With lock, L 365 mm, Ø 100 mm. Supplied without cable.

820432 9,95

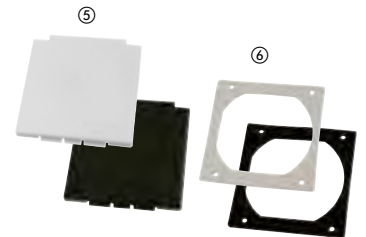
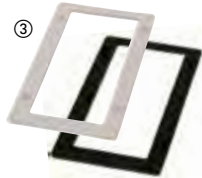

CEE input sockets and accessories, rectangular

① CEE input socket rectangular with seal and hinged cover, plastic.

Dimensions: 70 x 135 x 65 mm.

White 82140 16,95
Black 821400 16,95

White 821403 7,50
Black 821402 7,50

③ Rubber seal for rectangular CEE socket outlet. Dimensions: 70 x 135 x 65 mm.

White 821401 2,50
Black 821404 2,50

② Replacement rectangular cover

CEE input sockets and accessories square

④ CEE square input socket with seal and hinged lid. (Round installation pot) Dimensions: 105 x 105 mm.

White 82149 12,95
Black 821490 12,95

⑤ Square replacement cover

White (for 82149) 821493 6,-
Black (for 821490) (for 821490) 821492 6,-

⑥ Rubber seal for square CEE socket outlet. Dimensions: 105 x 105 mm.

White 821491 2,50
Black 821494 2,50

Cable with 3 x 1.5 mm² Cable cross-sections are not permitted for camping in Germany!

PROFESSIONAL SCHUKO ACCESSORIES FOR 230 VOLT



Cable drum with 4 sockets

Rubber cable with Schuko plug and 4 Schuko sockets with cover. For indoor use. Self-service package, splash-proof. H05 RR-F 3 x 1.5 mm² (Not permitted for camping in Germany!)
25 m **820451** **69,95**



Cable drum with 4 sockets

Rubber cable with Schuko plug and 4 Schuko sockets with cover. For indoor use. Self-service package, splash-proof. H05 RR-F 3 x 1.5 mm² (Not permitted for camping in Germany!)
7,5 m **82153** **13,19**



Hand cable drum

for rolling up the extension cable of max. 35 m, cable 2.5 mm²
82009 **11,95**



Cable transport bag

Convenient transport of cables. Suitable e.g. for hand cable drum (Art.-No.: 82009). Size: Ø 40 cm, Width: 14 cm.
820292 **9,95**



Power strip

Schuko plug to Schuko socket strip with hinged covers. For indoor use. With 2.5 m cable, H05 RR-F 3 x 1.5 mm². (Not permitted for camping in Germany!)
5-fold **82151** **12,67**



Schuko distributor plug

① **2-fold socket** with cover flaps
82201 **6,40**
② **3-way socket** with 1.5m cable
With cover flaps.
H07 RN-F 3 x 2.5 mm²
82202 **10,95**



Plug / Coupling

① **Schuko rubber plug**
82033 **2,95**
② **Schuko rubber coupling**
82034 **4,30**



Schuko distributor

Extension distributor Schuko/ Schuko Schuko plug to double Schuko socket. With 1.5 m cable and 2 lids. H07 RN-F 3 x 2.5 mm².
82006 **5,59**



Schuko safebox

to protect against moisture. Box without lock, L 210 x Ø 70 mm.
820431 **3,95**



Cable tie with handle

for bundling, carrying and storing. Can be used again and again. Suitable e.g. for 25 m cable (H07 RN-F 3G 2.5) or for 40 m cable (H07 RN-F 3G 1.5).
820091 **4,95**



Cables with 3 x 1.5 mm² cable cross-section are not permitted for outdoor use in Germany!

RELIABLE GAS DETECTORS

① GasStick - USB gas detector

- Warns of propane/butane gas (LPG) and anesthetic gases
- Easy installation via USB port in the vehicle
- Very low power consumption: Standby: 20 mA / Alarm: 22 mA

The extra-compact GasStick is supplied w/ power via a USB port (USB 2.0) in vehicle & reliably warns of propane, butane gas (LPG) & narcotic gas thanks to extremely high-quality & small MEMS technology (Micro-Electro-Mechanical Systems). An integrated LED indicates the device status. Acoustic warning signal: app. 70 dB. Minimalist design & uncomplicated installation make the GasStick a mobile gas detector for most energy sources with a USB connection. Insensitive to temperature fluctuations & humidity. Dim.: LxWxH approx. 77 x 28 x 10 mm.

80267 74,95

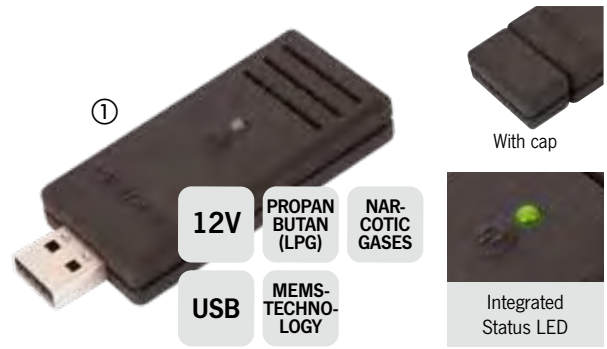

GasCube - Gas alarm in an elegant design

- Warns of propane/butane gas (LPG) & narcotic gases
- Visual and audible indication or warning

Fixed connection to 12 V on-board power supply. Pressure switch. Ready for operation after app. 3 min. With high sensitivity sensor & 80 dB loud siren. Temperature-controlled sensor that works reliably even above 25°C. Power consumption in standby: 100 mA, power consumption in alarm: 180 mA. Mounting: about 100 cm above the ground. Dims: 55.6 x 86.7 x 24 mm.

② GasCube Colour: Matt White 802482 64,95

③ Counter display (10x GasCube matt white) 802480 633,-

④ GasCubeTwin Equipment identical to GasCube above, but with connection options for two optional additional sensors. Cable length is 2.7 m. There are 3 possible combinations of additional sensors:

1. 2x sensor for detection of CO gas (carbon monoxide)
2. 2x Sensor for the detection of LPG gas/Anesthetic gas
3. 1x Sensor CO gas + 1x sensor LPG gas/Anesthetic gas.

Colour: Matt anthracite 802483 69,95

⑤ Additional sensor CO gas (Carbon monoxide) 802484 29,90

⑥ Additional sensor Propane/Butane Gas (LPG) 802485 29,95



⑦ LPG gas detector at TOP price

Reliably warns of gas leaks. Acoustic alarm: 85 dB, installation height for butane/propane gas detection: app. 20 to 40 cm above floor. 12 Volt, power consumption: 100 mA. Temp. range: -10/+50°C. Dim.: 115 x 70 x 60 mm. Scope of delivery: LPG gas detector, mounting material 80216 29,95

⑧ 2 in 1 combi gas detector

- Detects natural gas / LPG / CO gas
- 2 integrated sensors
- Self-test function, audible and visual alarm
- Wall bracket included for easy installation

Operating voltage: 12 volts, temp. range: -10°C ~ +50°C
Alarm volume: 85 dB, Power consumption: Standby 90 mA / with alarm 120 mA, Dim.: 125x80x40 mm 802180 39,90

⑨ Smoke detector w/ battery operation

- Monitoring area < 6m height: 60 m²
- Battery operation with 9 V block battery (not included)
- With test button for function test

Alarm as sound & light signal, alarm volume: 85 dB, dim.: Ø 130x40 mm. Including ceiling bracket for screwing on. 80300 24,90



12V LED LINE LIGHTS WITH ALUMINUM HOUSING

12V LED

from **18,90**

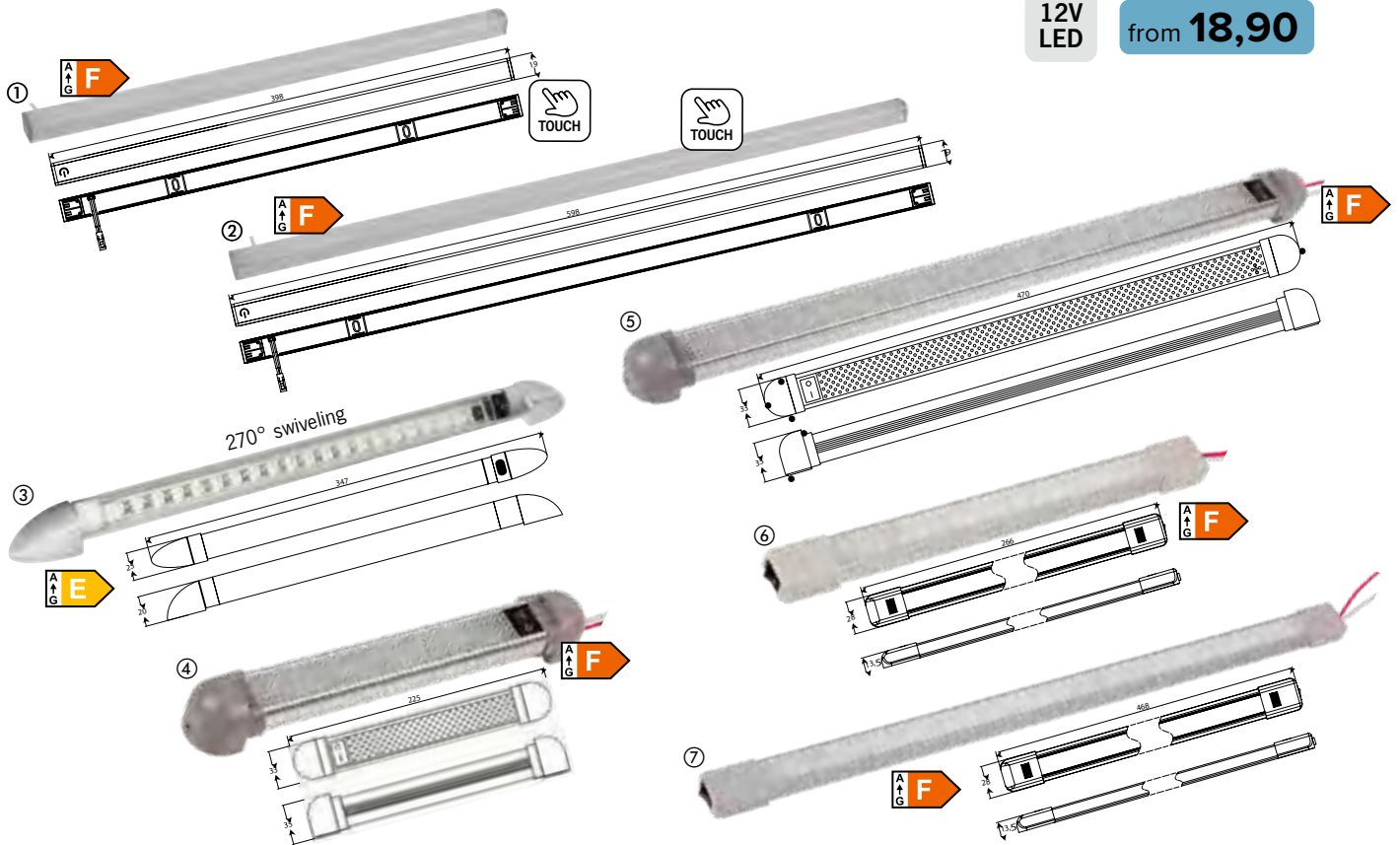

	①	②	③	④	⑤	⑥	⑦
Volt	12 V	12 V	12 V	12/24 V	12/24 V	12/24 V	12/24 V
Watt	5 W	7 W	2,8 W	2 W	6 W	3,6 W	7,2 W
LEDs	27	42	18	10	30	18	36
Lumen	360	470	288	180	520	340	570
Kelvin	3.000 K	3.000 K	3.000 K	3.000 K	3.000 K	3000 K	3000 K
Switch	Yes (Touch)	Yes (Touch)	Yes	Yes	Yes	Yes	Yes
Length	40 cm	60 cm	34,7 cm	22,5 cm	47,0 cm	26,6 cm	46,8 cm
Wide	1,9 cm	1,9 cm	2,5 cm	3,3 cm	3,3 cm	2,8 cm	2,8 cm
Height	-	-	2,0 cm	3,5 cm	3,5 cm	1,35 cm	1,35 cm
Item no.	83674	83675	835571	83241	83242	83243	83244
Price	21,95	29,90	33,90	18,90	39,90	19,90	33,90

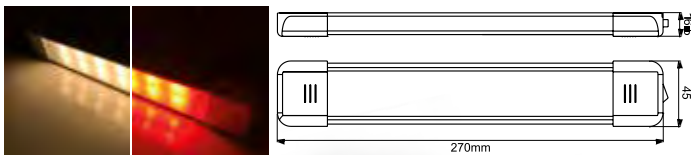

A G E

Fewer insects in the vehicle by red light

LED surface mounted luminaire Dual Colour

- Warm white light (3000K) for cozy ambient lighting
- Red light to avoid attracting insects
- Sturdy aluminum housing
- Easy assembly: screw or glue

The 12/24V Dual Colour LED light is equipped w/ 12 warm white SMD LEDs & additional 12 red SMD LEDs. Colour change takes place via switch.
Dimensions: 270 mm long, connection cable approx. 30 cm.

83589

36,95

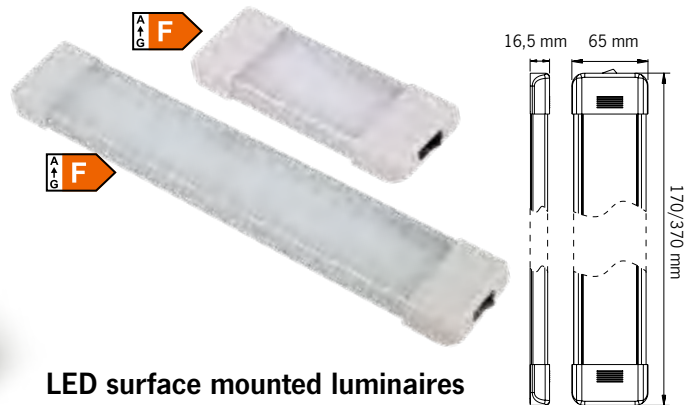

LED surface mounted luminaires

- Shapely aluminum housing
- Frosted glass pane

Elegant appearance, aluminum housing. 12/24V, with on/off switch. 3000K, IP65.

Length: 170mm, width: 65 mm 18 LEDs, 4 Watt, 348 Lumen
83245 **16,90**

Length: 370mm, width: 65 mm 54 LEDs, 11 Watt, 979 Lumen
83246 **39,95**

12V LED SURFACE LIGHTS

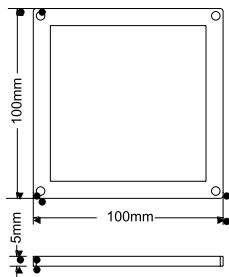

Super flat LED panel

- Only 5 mm thickness
- Chic silver frame
- Warm white light with 3,000 K
- 2 m connection cable

12 V/3 W, 184 lumen, Dimensions: 100 x 100 mm

83369

21,90

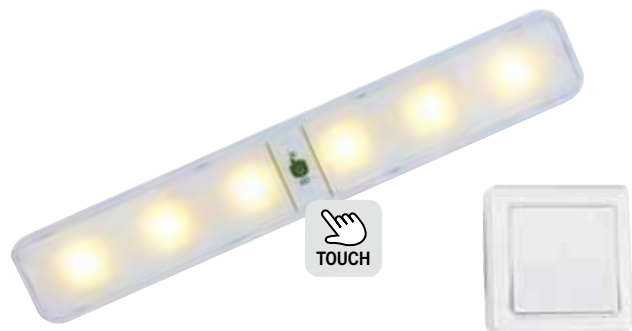

LED battery light with radio switch

- Ideal for the REIMO CampingBox
- Up to app. 56 hours of lighting time w/ only one set of batteries
- Radio switch with up to approx. 35 meters range (free area)
- Extremely bright

6 white LEDs, 55 lumens. Touch switch on the luminaire. Additional radio switch (range approx. 35 m) for on and off. Mounting possible by screws or adhesive strips. Dimensions radio switch: 85x85x20 mm, dimensions lamp: 300x50x20 mm. 3 x AAA battery for the switch and 4x AA battery for the light (not included). Mounting hardware included.

83154

18,33

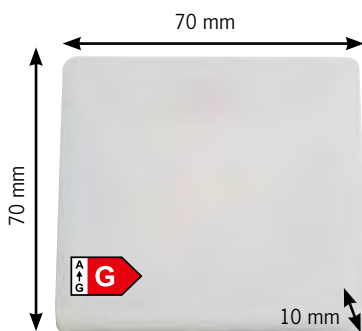

LED wall and ceiling lamp square

- Square shape
- Very flat & inconspicuous
- Design: opal white

Square LED wall and ceiling luminaire for surface mounting. Not dimmable. Dimensions (LxWxH): 70x70x10 mm, 12 V, 3 W, 3000 K, 199 lumen.

833732

9,95

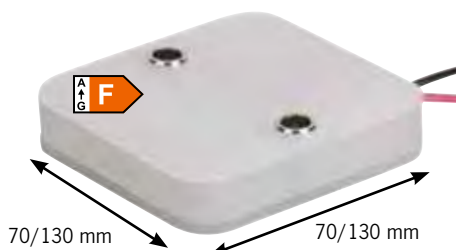

LED area light

Available in 2 sizes. For wall and ceiling, made of plastic in white, 3000 K, beam angle 180°.

Dimensions: 70 x 70 x 14.5 mm

24 SMD LEDs, 3 W, 210 lumen.

830341

15,26

Dimensions: 130 x 130 x 14.5 mm

33 SMD LEDs, 5 W, 350 lumen.

830342

18,66



LED surface-mounted light

Flat housing with high-quality frosted plastic pane and ON/OFF switch. Dimmable LEDs, 12 Volt, 6 Watt, dimensions: LxWxH 270x100x10 mm.

83627

45,90

12/24V LED AWNING LIGHT / AWNING LIGHT



12V
24V



For box van

12/24 V, colour: black, length: 231 mm, IP67, 3000 K, 2 W, 9 SMD LEDs, 222 lumen, ABS housing.

833771

21,90

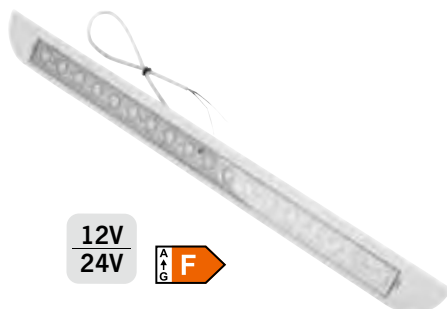

12V
24V



For motorhomes

12/24 V, colour: white, length: 480 mm, IP67, 3000 K, 4 W, 18 SMD LEDs, 388 lumen, ABS housing.

83377

27,90



12V



SMD LED awning light

- With motion detector
- For low energy costs
- Waterproof (IP66)

Silver plastic, polycarbonate glass, 576 lumen. Dimensions: L 325 x H 100 x D 35 mm with 36 LEDs, 6 watts.

830170

69,95

12V LED SURFACE MOUNTED LIGHTS



LED wall and ceiling lamp round (50 mm)

- Touch switch center
- Design: chrome

Round LED wall and ceiling light for surface mounting. Not dimmable. Shiny chrome, material: aluminum. Diameter: 50 mm, height: 8 mm, protection class: IP60, 1.5 W, 3000 K, 72 lumens.

833733 16,90



LED wall and ceiling lamp round (70 mm)

- Touch switch center, dimmable by touch switch
- Design: chrome

Round LED wall and ceiling light for surface mounting. Glossy chrome, diameter: 70 mm, height: 8 mm, protection class: IP60, 12 V / 3 W / 3000 K / 170 lumens.

833734 19,90

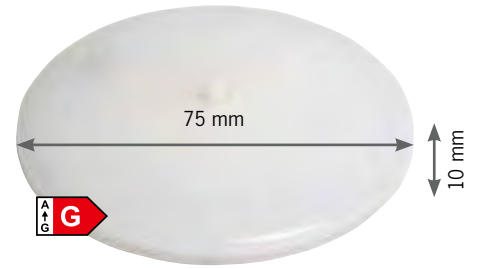

LED wall and ceiling light round (75 mm) with switch

- ON/OFF switch integrated
- Design: opal white

Round LED wall and ceiling luminaire for surface mounting. Not dimmable. Diameter: 75 mm. Height: 10 mm. 12 V / 3 W / 3000 K / 190 lumens.

833731 9,95

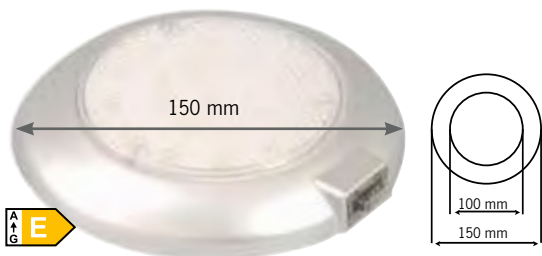

LED wall and ceiling lamp round (150 mm) with switch

With 3 level switch, night light, level 1: on, level 2: off, level 3: 50%. 18 SMD LEDs, 3 W, 288 lumens. Ø 150 mm. Colour: Silver grey

832381 32,95



LED wall and ceiling lamp round (175 mm)

- Touch switch center
- 3-stage switching (weak, medium, bright)
- Design: silver

Round LED ceiling light, silver glossy. Not dimmable. Diameter: 175 mm, height: 18 mm, IP44, 12 V / 7 W / 3000 K / 447 lumens.

835721 39,95

12V LED SURFACE MOUNTED LIGHTS WITH NIGHT LIGHT

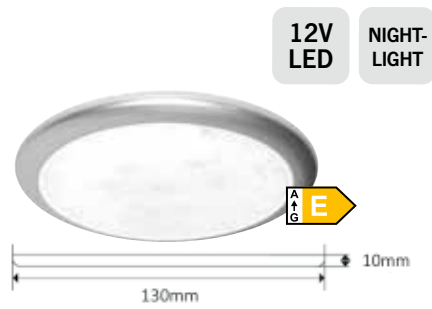

LED luminaire Down Light Slim

With touch switch
Very flat plastic housing
Light white/blue switchable

Round ceiling light with 2 light colours. 36 warm white LEDs (4900-5300 K, 576 lumen) or 6 blue LEDs as night light. 5.7 W, beam angle 120°. Dims.: Ø 130 x 10 mm. Not dimmable.

835490 42,46



LED light Mini Slim Down Light

Touch switch
Light white/blue switchable

Round LED light with 2 light colours. 12 warm white LEDs (3000 K, 192 lumen) or 6 blue LEDs as night light. 1.9 W. Beam angle 120°. IP66. Dims.: Ø 69 x H 9.6 mm. Not dimmable.

835491 24,90



LED light SlimLite

Flat surface mounted light
With push button switch (On/White/Blue)
Aluminum coloured plastic housing

Rectangular ceiling light with 2 light colours. 36 warm white LEDs (4000 K, 576 lumen) or 12 blue LEDs as night light. 5.7 W, beam angle 120°. Silver housing with switch. Dims.: 185x110 mm. Not dimmable.

835492 54,90



12V LED NIGHT-LIGHT

LED ceiling light

Light white/blue switchable
Ceiling light w/ 36 white LEDs & 12 blue night light LEDs. Silver with switch. Dims.: 156 x 124 x 13.5 mm, 450 lumens, 7 watts.

83536 35,58



12V LED NIGHT-LIGHT

Surface mounted LED spotlight

6 x blue night light LEDs
12 white LEDs

1.9 W / 192 lumen, dims. 84 x 10 mm, with switch. Not dimmable.

83996 27,95

12V LED SURFACE MOUNTED SPOTLIGHTS



LED spot with touch switch and glass shade

12V, incl. night light function, material: brushed nickel, 3000 K, 2 W, 1x COB LED, 180 lumen, dimmable via touch switch, Weight: approx. 230g.

83187 18,95



LED spotlight w/ touch switch and USB port in base

12 V, incl. night light function, glass shade, material: brushed nickel, 3000 K, 2 W, 1x COB LED, 180 lumen, dimmable via touch-switch, weight: approx. 190g.

83189 29,90



LED spot with touch switch and lampshade in white

12V, incl. night light function, elegant lampshade in white, material: chrome, 3000 K, 2 W, 1x COB LED, 180 lumen, dimmable via touch-switch, weight: approx. 170 g.

83188 23,76

12V / 24V LED RECESSED LIGHTS



A ↑ G

Aluminum LED spotlight
12V, square shape, spotlight swivel, material: brushed aluminum
Not dimmable. 65 x 65 mm, 108 lumens, 2 W, 3,000K **831582 16,90**



A ↑ G

Stainless steel LED spotlight
12 V, 1.7 W, brushed stainless steel, 3,000 K, 165 lumen, 9 LEDs, non-dimmable, dims.: app. Ø 65 x 12 mm. **83676 9,99**



A ↑ G

Stainless steel LED spotlight
12 V, 1.7 W, brushed stainless steel, 3,000 K, 180 lumen, 24 LEDs, non-dimmable, dims.: app. Ø 65 x 12 mm **83670 9,99**

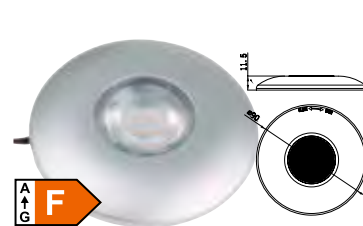

A ↑ G

LED spotlight, silver
12V, 2.2W, 3,000K, 200 lumen, not dimmable. Dimensions: Ø 90 mm, H 11.5 mm. Colour silver. **83673 9,99**



A ↑ G

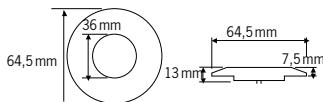

Mini downlight 1,5 W
24 SMD LEDs, 1.9 W, 168 lumens, non-dimm, Ø 63.2 mm, inst. opening Ø 45 mm. **83231 24,95**



A ↑ G

12V
24V

LED Spotlight
Colour: white, 3000K, 2 W, 12 SMD LEDs, 190 lumen, non-dimmable, ABS housing. Dims.: Ø 75x18mm. IP67. **83373 9,98**



A ↑ G

Ceiling spot Wave
3 white LEDs w/ switch. Ø 105 x H 24 mm. Plastic/metal, silver, swiveling. 3 x 1 W, 80 lumen, not dimmable **83533 35,90**



A ↑ G

12V LED TOUCH E24

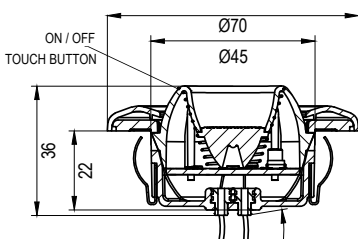

CARBEST by **SSANEL** AUTO ELECTRONIC
LED recessed spotlight made of ABS plastic
With touch switch in the spotlight
Pivotable
Round LED recessed spot Ø 70, with clamp bracket. 1x SMD LED, 12 V, 1 W, 60 lumen, IP 54, LED colour warm white (3000 K). Bore: 45 mm. Silver matte **83620 24,90**



A ↑ G

12V
24V

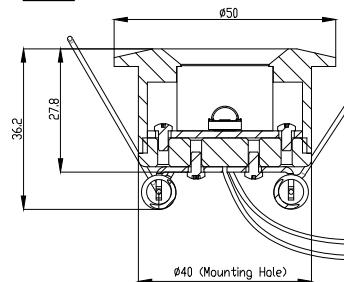

CARBEST by **SSANEL** AUTO ELECTRONIC
LED recessed spotlight made of aluminum
Round LED recessed spot Ø 50 mm, with clamp bracket. 12 V, 1.5 W, 125 lumen, IP 54, LED colour warm white (3000 K). Bore: 40 mm. Silver matte **83621 24,90**



12V
24V

LED mini recessed spot stainless steel
• Very small and compact
• Clamp mount
• Stainless steel housing
Round LED mini recessed spotlight made of stainless steel with clamp bracket. Not dimmable. Bore: 13 mm, IP65, 53 lumens, 1 W, 3000 K. **837080 12,90**

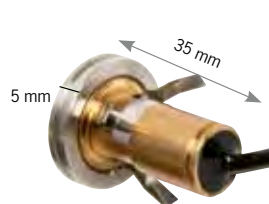

LED mini recessed spotlight plastic
• Very small and compact
• Flat design (only 4 mm thick)
Round LED mini recessed spotlight made of plastic w/ mounting thread. Not dimmable. Bore: 15 mm, 69 lumens, 1 W, 3000 K. **837081 12,90**

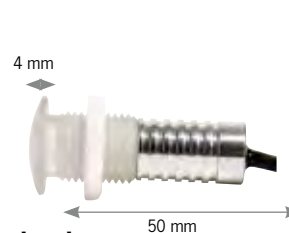

12V LED COCKPIT LIGHTS/GOOSENECK LIGHTS



LED spot with flexible arm

- Noble design in black matt
- Flexible arm
- ON/OFF switch

LED spot with flexible arm and integrated glass shade. Not dimmable. Ideal for seating area or bedroom. Material: aluminum / plastic, total length: 150 mm / flex arm length: 90 mm, ON / OFF switch, 3000 K, 1.8 W, 99 lumens, 6 x SMD LEDs. **830346 26,90**



LED spot w/ flexible arm & USB charging socket

- Noble design in white matt
- Flexible arm
- ON/OFF switch
- USB port in the socket (1x2 A)

LED spot with flexible arm and integrated glass shade. Not dimmable. Ideal for seating area or bedroom. Material: aluminum / plastic, total length: 150 mm / flex arm length: 90 mm, USB port in base (1x2 A), ON/OFF switch, 1.8 W, 80 lumens, 3000 K, 6 x SMD LEDs. **830345 29,99**

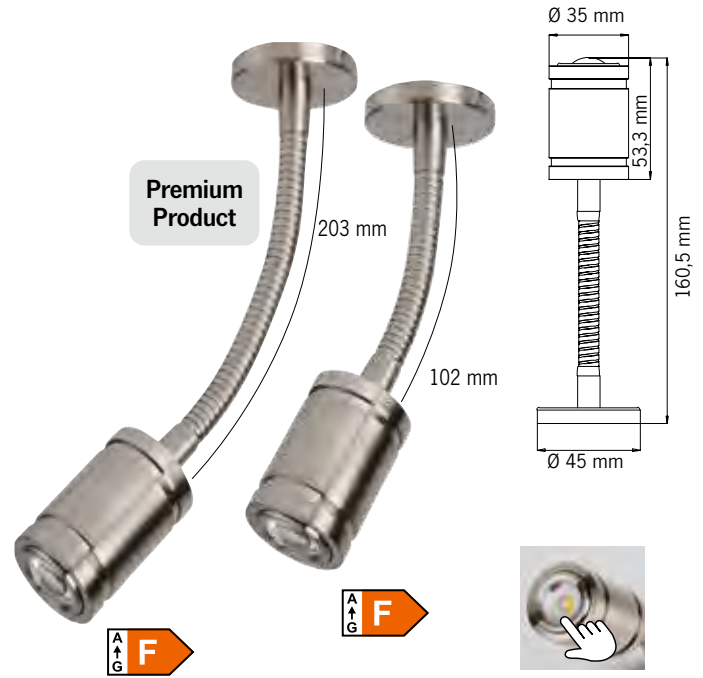

Premium Product

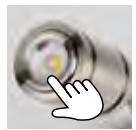

ON/OFF switch integrated in luminaire head

Brushed nickel reading lamp in two lengths

LED reading light, dimmable if additional dimmer is available.

Ø 35 mm, 12 V, 1.2 W, warm white (3,000 K), 100 lm, beam angle 120°.

Lifetime approx. 20,000 hours.

Total height: 160.5 mm **830343 35,90**

Total height: 300.5 mm **830344 39,90**



29,90

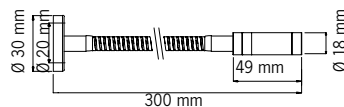
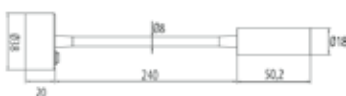

Flexible LED Spot

Power LED Spot with 2 W LED 110 lumens. Flexible arm, total length 200 mm. With switch, not dimmable, colour black.

83394 29,90

Flexible LED Spot

COB LED Spot with 2 W LED. 100 lumens. Flexible arm, total length 300 mm. 3000 K. Not dimmable.

83398 21,90



Luminaire with wall bracket



Clip holder



4-in-1 Rechargeable magnetic light

- Multifunctional use: As a table lamp - With clip holder - With wall holder
- As a flashlight
- 6 warm white LEDs (3000 K)
- 3 adjustable light levels
- Rechargeable via USB-C cable (included)
- Elegant metal housing in matt black
- ON/OFF touch sensor on luminaire head

Scope of delivery

The battery-powered lamp head can be removed from table lamp frame & attached to clip holder or wall bracket using a magnet. Means that magnetic light can be used individually.

Scope of delivery: rechargeable lamp head, table lamp stand, clip holder, wall bracket, USB-C charging cable (length 0.8 m). Technical data: Li-ion battery (1x1200 mah). IP20, weight: 0.65 kg, dimensions: lamp head Ø40 mm, L: 110 mm, table frame H: 335 mm. IP20.

831953

29,95



Image similar

LED FLEX TAPES WARM WHITE

- Atmospheric lighting indoors / outdoors
- All LED flex ribbons are dimmable with optional dimmer
- Self adhesive back
- Can be shortened after every 3rd LED

12 V LED flex strip warm white for indoor & outdoor use
30 LEDs/m, 2.4 W/m, 190 Lumen/m, 3,000 K, warm white, IP66,,5 m roll, tape width: 7 mm **83174 24,90**

12 V LED flex strip warm white for indoor & outdoor use
60LEDs/m, 4.8 W/m, 320 Lumen/m, 3,000 K, warm white, IP67, 5 m roll, tape width: 7 mm **83171 44,90**

12 V LED flex strip warm white for indoor & outdoor use
120 LEDs/m, 7.2 W/m, 480 lumen/m, 3,000 K, ideal as awning lighting, incl. 1 m connection cable (waterproof), warm white, IP67, 5 m roll, tape width: 10 mm **83170 69,90**

12 V LED flex strip warm white for indoor use
60 LEDs/m, 4.8 W/m, 290 Lumen/m, 3,000 K, warm white, IP20, 5 m roll, tape width: 5 mm **83172 34,90**



Image similar

12 V LED flex strip RGB + warm white 72 LEDs/m, can be shortened after every 6th LED. Dimmable. 10.8 W/m (all LEDs), 2.2 W/m (warm white LEDs). Warm white: 250 Lm/m, red: 72 Lm/m, Yellow: 138 Lm/m, Blue: 35 Lm/m. 3.000 K warm white, 5 m roll, Strip width: 10 mm. **83175 74,90**

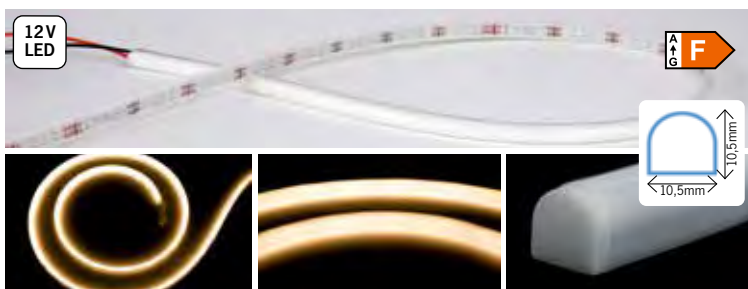

Fig. shows flex strip with LEDs in RGB and warm white (83175)

CONTROL UNIT FOR LED FLEX STRIP RGB+W



RGB+W control unit with remote control Specially for RGB+W LED flex strip 83175. For controlling lighting effects and light colour. **83179 22,90**



Flexible LED light tube for indoor & outdoor use

150 LEDs, 10.8 W, 620 lumen, 3,000 K warm white, IP67, dimmable, 5 m roll with self-adhesive backing (3M), tape width: 10 mm

83178

76,42



12/24 V Dimmer with remote control

For single-colour LED strips or dimmable luminaires. Functions: Lighter/darker, on/off. Ideal for retrofitting awning lighting, as there is no need to install an additional switch. 12V < 96W, 24V < 192W. Quiescent current app. 30 mA. Dims.: LxWxH 90x60x37 mm.

831003 19,90

STYLE ALUMINUM PROFILES FOR ALL LED FLEXBANDS WITH 10 mm WIDTH

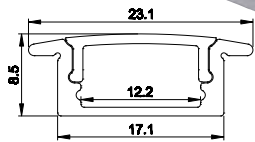

①

②

Including cover
(satinized)

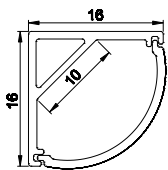

③

④

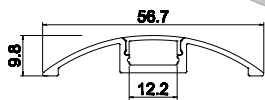

⑤

Cover (satin)

⑥

Cover (opal)

- Individual luminaire construction for atmospheric lighting
- Profile length: 1.5 m, suitable for LED flex strips with a maximum width of 10 mm
- All aluminum profiles incl. 2 end caps
- Suitable for the Carbest LED flexbands
- Perfect combination with furniture panels and furniture parts

The aluminum profiles are a professional solution for laying LED strips. You can easily create your own lighting with the profiles and LED strips on the right.

The profiles are also ideal for use in furniture construction, e.g. to conceal transition between different wooden panels or to provide stylish lighting. This specifically illuminates corners and areas under cabinets and shelves. When it comes to light diffusion, you can choose between semi-transparent satin cover or opal version with a white appearance.

Each set comes with 2 end caps, which you can extend with additional end caps. Suitable for LED strips with a maximum width of 10 mm.

All aluminum profiles are supplied WITHOUT LED flex bands.

- | | | | |
|--|--|---------------|--------------|
| ① Flat aluminum profile including 2 end caps | For surface mounting or recessing in a groove. Length: 1.5 m, without cover. | 82999 | 9,95 |
| End caps for 82999 (2 pieces) | | 82980 | 1,95 |
| ② Angled aluminum profile including cover and 2 end caps | For mounting in corners and under cupboards. Length: 1.5 m | 829991 | 15,95 |
| End caps for 829991 (2 pieces) | | 82981 | 1,95 |
| ③ Fixing clips for 82 9991 (2 pieces) | | 829810 | 1,95 |
| ④ Semicircular aluminum profile including 2 end caps | For screwing on and covering transitions of e.g. furniture panels. Length: 1.5 m, without cover. | 829992 | 15,95 |
| End caps for 829992 (2 pieces) | | 82982 | 1,95 |
| ⑤ Satin cover (semi-transparent) | Suitable for 82999 / 829992. Length: 1.5 m. | 82983 | 6,95 |
| ⑥ Opal cover (opaque white) | Suitable for 82999 / 829992. Length: 1.5 m. | 82984 | 6,95 |

12V SMD LED TECHNOLOGY

Flat plates with side pins

- ① Type S, 9 x SMD, 1.5 watts, 120 lumens, Ø 25 x 8 mm, angle 120°, G4 base, dimmable. **830326** **5,90**
- ② Type M, 9 x SMD, 1.5 watts, 150 lumens, Ø 27 x 8 mm, angle 120°, G4 base, dimmable. **830327** **7,90**
- ③ Type L, 21 x SMD, 3.0 watts, 270 lumens, Ø 35 x 8 mm, angle 120°, G4 base, not dimmable. **830328** **7,90**

Pin-base LEDs

- ④ 4 x SMD, 1.5 watts, 60 lumens, Ø 11.2 x H 23.5 mm, angle 120°, G4 base, not dimmable. **830320** **5,95**
- ⑤ 15 x SMD, 1 watt, 82 lumen, Ø 12 x H 22 mm, angle 120°, G4 base, dimmable. **830322** **5,90**

LED cold light mirror MR11

- ⑥ 9 x SMD, 1.5 watts, 120 lumens, Ø 34.5 x H 39 mm, angle 120°, GU4 base, not dimmable. Material: aluminum. **830336** **8,90**

12V COB-LED TECHNOLOGY

- ① 1 x COB LED, 1.5 watt, 90-100 lumen, 3000K, IP20, Ø10 x 22 mm. Angle 220°, G4 base, non-dimmable, material: silicone **830329** **7,90**
- ② 1 x COB LED, 2 watts, 200 lumens, 3000K, IP20, Ø 10 x 30 mm, 360° angle, G4 base, non-dimmable, material: silicone **830331** **9,95**
- ③ 5 x COB LED, 5 watt, 400 lumen, 3000K, IP20, W 15.3 x H 33 mm, Angle 120°, G4 base, not dimmable, material: aluminum, **830332** **5,53**

OUTDOOR LIGHTS

- All lights with integrated rechargeable battery via USB
- All lights for standing or hanging in tents
- Cold white light

① Large light with mosquito protection

2000 mAh rechargeable battery, 3.2 W 16 SMD LEDs, integrated mosquito protection light and power bank function. 4-stage switching: 100% light output / 50% light output / signal flashing / off. Dimensions: Ø 98 x height: 135/190 mm. **930614** **24,95**

② Rechargeable camping light with mosquito protection

2000 mAh battery, 1 W, integrated mosquito repellent light. With charge indicator. 4-stage switching: 20% light output / 50% light output / 100% light output / Off. Dimensions: Ø 88 x 129 mm. **83494** **24,95**

③ Small globe light

1000 mAh battery, 1.5 W 3 SMD LEDs, lighting time max. 14 hours. 4-stage switching: 100% light output / 50% light output, 20% Light output / Off. IPX7, Dimensions: Ø 80 x 102 mm. **930613** **11,95**

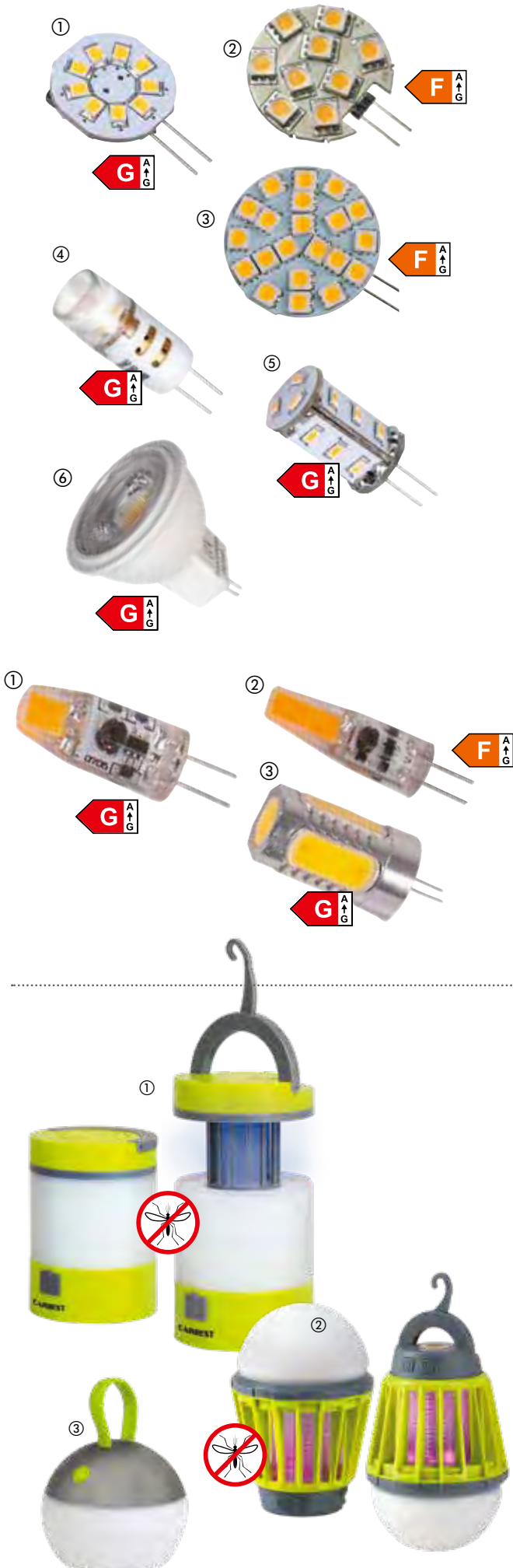

STRONG LED/COB LED LUMINAIRES

LED Torch Lights

- LED light with atmospheric realistic flame effect
- Rechargeable via micro USB

① LED table lamp with integrated Bluetooth speaker

Uncomplicated pairing with the smartphone. Transmission range >10 m. Volume >90 dB. Power supply: 5 V 1 A. Output power: 5 W. 2000 mAh Li-polymer battery. Material: ABS. Dims.: Ø 98 x H165 mm **83184 27,95**

② LED rod torch with flame effect

Authentic flame effect with 96 LEDs. 2 W, 100-200 lumens. Integrated 2200 mAh battery. Rechargeable via solar panel in the lid or via micro USB cable. Dimensions: Ø 95 mm, with 4 bar elements, max. height 830 mm **83588 24,95**

③ Solar light chain

Atmospheric party light chain with 10 LED lanterns

With solar panel (2 V, 10 mA) and rechargeable batteries. Burn time about 8 hours, cable length 4 meters. **83183 9,50**

④ COB multi-function pen light

Battery operated (3 x AAA). U-clip, ultra-bright LED, with loop. **83528 6,76**

⑤ COB clamp light

3 W COB + 1 SMD LED, 120 lumens + 30, lumens, 3 x AAA batteries (not included), 2 strong magnets on the back, clamp function, with joint for optimal adjustment possibilities **83490 8,42**



BatteryCamping light with adjustable light temperature

- Adjustable light temperature (cool white, warm white, cool/warm white)
- Dimmable in any light temperature
- Additional flashing mode
- Powerbank function: other mobile devices can be charged via the USB-A output
- Snap hook in the base of the light

At the touch of a button, light temp. of the 46 SMD LEDs can be selected:
 Mode 1: cool white (Luminous duration: 3.5 h)
 Mode 2: warm white (Lighting duration: 4.5 h)
 Mode 3: cold/warm white (Luminous duration: 2.0 h)
 Mode 4: Flashing mode (Light duration: 5.0 h)
 Brightness: max. 1000 lumens.

The light can be dimmed continuously by pressing and holding. The integrated lithium battery (2x 2200 mAh) can be recharged via a USB cable (included). Dims. WxDxH: 100x95x188 mm, weight: 510g.

834875 34,90

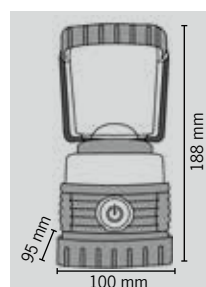
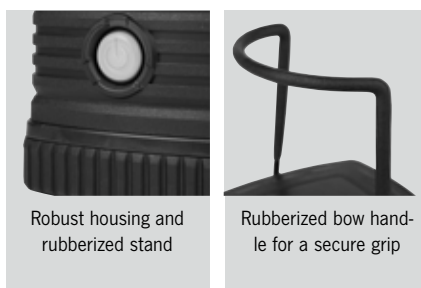

VEHICLE REFINEMENT AND VEHICLE INSULATION

X-Trem® Stretch Carpet Felt

- 4-way / superstretch (4-way superstretch)
- Due to the special stretching ability, even curves such as wheel arches are no problem
- Suitable for all surfaces (wood, plastic, metal and also on insulation)
- Thickness approx. 4.6 mm
- Weight approx. 390 g/sqm
- In 5 different colours
- Material: 100% polyester

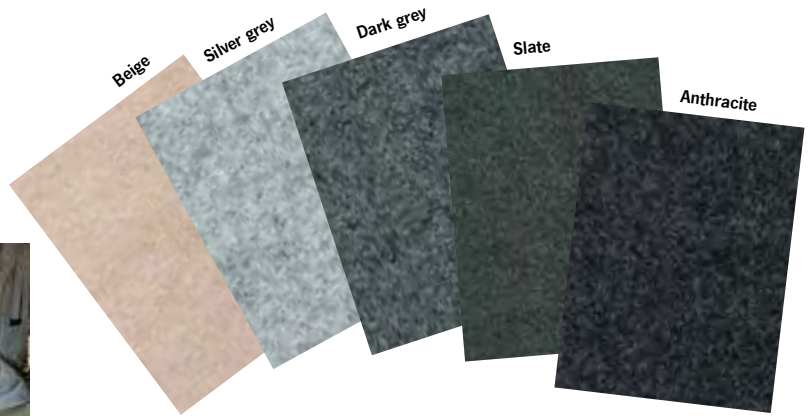

Colour	Cut to size W 2 x L 2 m (4 m²)			Blank W 2 x L 5 m (10 m²)			Roll W 2 x L 30 m (60 m²)		
Beige	500891	79,-	GP* 19,75/sqm	500890	145,-	GP* 14,50/sqm	50089	579,-	GP* 9,65/sqm
Silver grey	500831	75,60	GP* 18,90/sqm	500830	139,-	GP* 13,90sqm	50083	612,-	GP* 10,20/sqm
Dark grey	500841	75,60	GP* 18,90/sqm	500840	139,-	GP* 13,90/sqm	50084	612,-	GP* 10,20/sqm
Slate	500851	79,-	GP* 19,75/sqm	500850	145,-	GP* 14,50/sqm	50085	579,-	GP* 9,65/sqm
Anthracite	500881	75,60	GP* 18,90/sqm	500880	139,-	GP* 13,90/sqm	50088	612,-	GP* 10,20/sqm

Quilted interior trim for Volkswagen T5/T6 vans without windows

- Homely ambience in VW T6 without windows
- Chic imitation leather look with quilting
- Mounting material included

Easy to attach with dowels in the existing holes in Volkswagen T5/T6 (without glazing) or with Velcro. Mounting material included in delivery. The material is colour coordinated with the VW interior colours.

① 1x panels for sliding door	32000	149,-
② 1x panels for side opposite sliding door	32001	155,-
③ 1x panel for rear right side window	32002	149,-
④ 1x panels for rear left side window	32003	149,-

FIT:

Imitation leather, grained, for other interior trim (e.g. spars) Light grey, laminated with 3 mm foam	510211	44,95
Light grey, unlaminated	510211-1	30,95



X-Trem® Noise Regulator Self-adhesive noise & sound insulation

- Excellent noise insulation and soundproofing
- Self-adhesive, with strong surface adhesion
- Aluminum butyl, 2 mm thick, aluminum coated, odorless
- Without bitumen, not mixed with petroleum or asphalt
- Heat reflective

Temperature resistant from -30°C to +80°C
Adhesive layer covered with protective film.

100 x 50 cm	GP 29,00/1 sqm	50098	14,50
500 x 40 cm	GP 24,95/1 sqm	50099	49,90

Please wear gloves to protect against the sharp-edged film when processing.

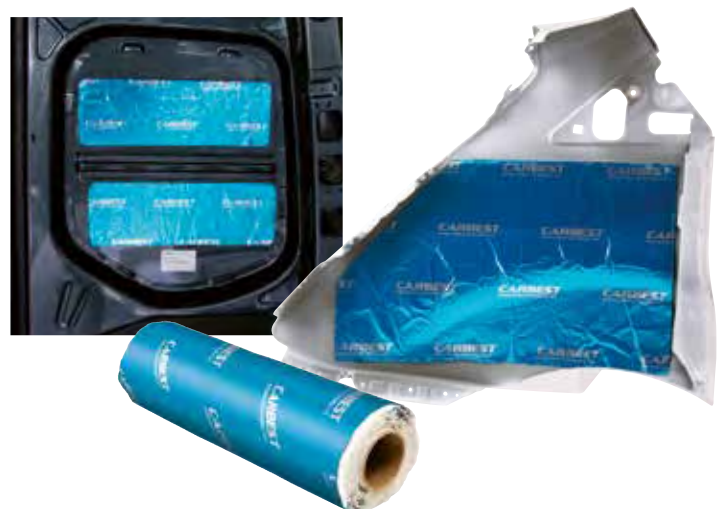

PROTECT YOUR VEHICLE FROM DAMAGE



Volkswagen Transporter New Multivan
Volkswagen ID.BUZZ
Ford Transit Custom V710



① Brushed stainless steel



② Black brushed stainless steel



③ Stainless steel black



④ Stainless steel with carbon foil

Bumper protection made of high quality stainless steel

For Citroën Spacetourer 2017, Citroën Jumpy > 2017, Toyota Verso III > 2017, Toyota Proace III > 2017, Opel Zafira Life > 2019, Opel Vivaro > 2019, Peugeot Expert > 2017, Peugeot Traveller > 2017

① Brushed stainless steel, short wheelbase	45830	75,90
① Brushed stainless steel, long wheelbase	45832	75,90
② Brushed black stainless steel, short wheelbase	45831	89,90

For Volkswagen Caddy/Caddy Maxi > 2020 Brushed stainless steel

	45847	65,90
--	-------	-------

For Volkswagen Transporter 6.1/6, Caravelle & Multivan > 2015

① Brushed stainless steel (single door)	45841	56,90
② Black brushed stainless steel (single door)	45842	67,90

For Volkswagen Transporter 5, Caravelle & Multivan 2003-2015 Van, VW T6/T6.1 Transporter > 2015 Van

① Brushed stainless steel	45843	49,90
③ Stainless steel black	45844	59,90
④ Stainless steel & carbon foil	45845	41,90

For Volkswagen New Multivan > 6/2021

① Brushed stainless steel	45822	56,90
---------------------------	-------	-------

For Volkswagen ID.BUZZ > 2022

① Brushed stainless steel	45819	56,90
---------------------------	-------	-------

For Mercedes-Benz Vito W447 2014

① Brushed stainless steel	45833	52,90
② Brushed black stainless steel	45834	64,90

For Fiat Talento > 2016, Opel Vivaro III 2014-2019, Renault Traffic III > 2014

① Brushed stainless steel	45839	56,90
③ Stainless steel black	45840	57,72

For Ford Transit Custom V710 > 2024

① Brushed stainless steel	45817	56,90
③ Stainless steel black	45818	56,90

For Volkswagen Crafter > 2017 Van

① Brushed stainless steel	45846	79,90
---------------------------	-------	-------

For Mercedes-Benz Sprinter 2006-2018, Volkswagen Crafter 2006-2017 Van

① Brushed stainless steel	45835	44,97
③ Stainless steel black	45836	70,47

For Mercedes-Benz Sprinter > 2018

① Brushed stainless steel	45837	59,90
③ Stainless steel black	45838	64,52



Mirror protectors set (left & right)

- For Fiat Ducato / Citroën Jumper /
- Peugeot Boxer > 2006 (X250 and X290)
- Material plastic, high gloss lacquered

Protects the mirror from damage or hides existing damage. Long version for semi-integrated and alcoves, short version for campers. Available in white, chrome and black.

① White:	Short version	45815	69,95
	Long version	45816	69,95
② Chrome:	Short version	45811	67,96
	Long version	45812	79,95
③ Black:	Short version	45813	69,95
	Long version	45814	69,95



① Mirror protectors for minivans

For Citroën Jumpy > 2017, Citroën Spacetourer 2017, Citroën Berlingo III Panel Van > 2019, Citroën Berlingo III Passenger Van > 2019, Opel Vivaro > 2019, Peugeot Expert > 2017, Peugeot Traveller > 2017, Toyota Proace III > 2017 ABS Chrome,
2 pcs. 45850 50,96

ENTRANCE MATS



Premium quality:

- Top made of grey needlefelt
- Edges bordered
- 2 adhesive strips on the bottom for optimal fixation

Classic quality:

- Black courier top
- Edges bordered

Access mat sets

High-quality entrance mat sets to protect the vehicle interior from moisture and dirt.

Set of 2 = 2 cab mats

Set of 3 = 2 mats cab + 1 mat sliding door

Set of 4 = 2 mats cab + 2 mats sliding door

Vehicle type	① Colour grey with black border		② Colour anthracite striped	
NEW 2024 Volkswagen ID.Buzz			51815 (set of 2)	14,95
Volkswagen Transporter 4			51801 (set of 2)	15,95
Volkswagen Transporter 6.1 / 5	516010 (set of 3)	59,95	51802 (set of 2)	15,95
Volkswagen Transporter 7			51804 (set of 2)	15,95
Mercedes-Benz Vito/Viano > 2014	516013 (set of 3)	59,95	51813 (set of 2)	15,95
Citroën Spacetourer > 2016	516012 (set of 4)	69,95	51689 (set of 2)	15,95
Fiat Ducato > 2006	516016 (set of 2)	49,95	51806 (set of 2)	15,95
Fiat Ducato > 2014	516016 (set of 2)	49,95	51808 (set of 2)	15,95
Volkswagen Crafter > 2018	516011 (set of 2)	49,95	51800 (set of 2)	15,95
Mercedes-Benz Sprinter 2014 -18			51811 (set of 2)	13,56
Mercedes-Benz Sprinter > 2018	516014 (set of 2)	49,95	51800 (set of 2)	15,95
Ford Transit > 2014			51809 (set of 2)	15,95
Ford Transit Custom > 2016	516015 (set of 2)	49,95	51810 (set of 2)	15,95

DOOR SILL TRIMS



VW T5/T6 > 2014

- Protective strips in black ABS
- Effectively protect the sills and the paint in the heavily used entry area of the vehicle from scratches

Set of 2 sill plates 45860 39,95



Fiat Ducato > 2014 and Fiat Ducato 8 > 09/21

- Protective strips in black ABS
- Effectively protect the sills and the paint in the heavily used entry area of the vehicle from scratches

Set of 2 sill plates 45861 39,95

FOOTMATS



Floor mats/carpet for Campster/Vanster/Campstar/Vanstar from Pössl, Citroën Spacetourer, Peugeot Traveller, Mercedes-Benz Vito and identical models

Mats for the footwell under the dashboard, entry, trunk u. Wohnraum. Material: synthetic fiber 1900g/m² in grey and anthracite, each with black stripes.

Carpet for	For Pössl Campster			For Pössl Vanster			For Pössl Campstar			For Pössl Vanstar		
	Colour grey	Colour anthracite	Price	Colour grey	Colour anthracite	Price	Colour grey	Colour anthracite	Price	Colour grey	Colour anthracite	Price
① Cab	51686	51687	53,95	51032	51033	51,95	51700	51701	53,95	51714	51715	53,95
② Cab entry (2 pcs.)	51688	51689	15,95	51688	51689	15,95	51702	51703	15,95	51702	51703	15,95
③ Living space entry	51698	51699	19,95	51698	51699	19,95	51704	51705	19,95	51704	51705	19,95
Living space o. rails	51690	51691	53,95	516000	516001	51,95	51706	51707	53,95	51720	51721	53,95
④ Living space w. rails	51692	51693	61,95	516002	516003	59,95	51708	51709	61,95	51722	51723	61,95
Trunk or rails	51694	51695	46,95	516004	516005	45,95	51710	51711	46,95	51724	51725	46,95
⑤ Trunk w. rails	51696	51697	56,95	516006	516007	55,95	51712	51713	56,95	51726	51727	56,95

CAB FLOOR MATS

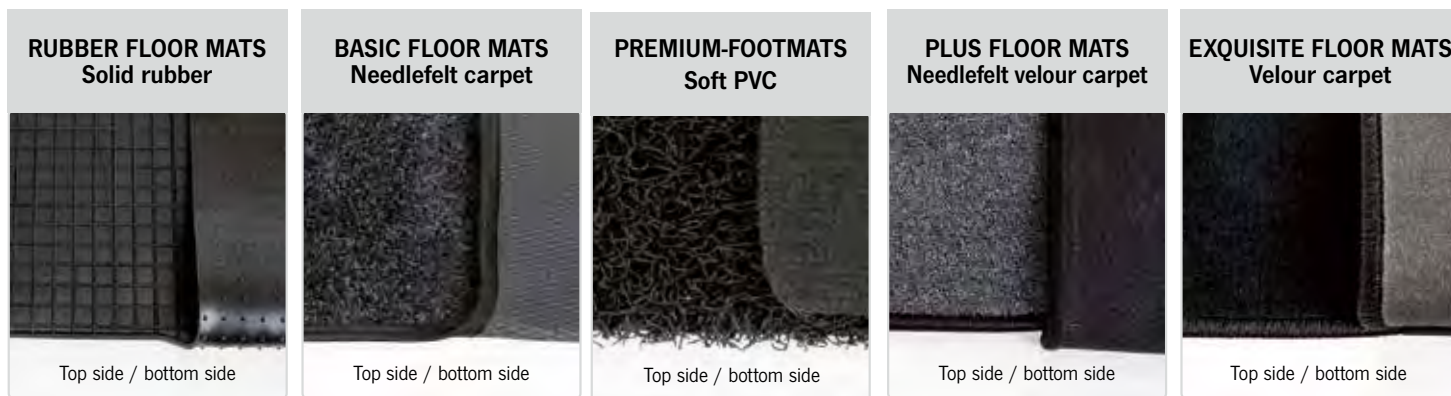

- Top with grid structure
- Perfectly protects the interior from moisture
- Nubbed underside prevents slipping
- Colour: Black

- Needle fleece top
- Edges hemmed - no fraying
- Back with non-slip plastic structure
- Colour: Anthracite

- 10 mm thickness
- Hygienic
- Easy to clean
- 100% PVC, recyclable
- Anti-slip back
- Antistatic
- Colour: Black

- Top made of dense needlefelt velour
- Back with non-slip rubber granules
- Edges bordered - no fraying possible
- Colour: anthracite mottled

- High quality top made of soft velour w/ noble look
- High quality edging
- Non-slip rubber back
- PU back coating for even more insulation
- Colour: Black

Vehicle type	YOC.	Rubber mats (solid rubber)		BASIC Floor mats		Premium floor mats		PLUS Floor mats		EXQUISIT Floor mats	
Fiat Ducato/PeugeotBoxer/CitrëonJumper	1994 - 2002	---	---	---	---	515803	54,-	51561	77,95	516018	116,45
Fiat Ducato/PeugeotBoxer/CitrëonJumper	2002 - 2006	51680	44,95	51622	32,95	515802	45,-	51567	77,95	516017	116,45
Fiat Ducato/PeugeotBoxer/CitrëonJumper	2006 - 2014	51681	45,95	51673	39,95	515801	39,95	515711	77,95	516051	137,-
Fiat Ducato/PeugeotBoxer/CitrëonJumper	> 2014	51681	45,95	51674	39,95	515800	39,95	515711	77,95	516051	137,-
Opel Movano	> 2021										
Volkswagen Caddy/ Volkswagen Caddy Maxi	2008 - 2020	516802	33,95	---	---	---	---	515712	71,95	---	---
Volkswagen Caddy/ Volkswagen Caddy Maxi	> 2020	516814	29,95	---	---	---	---	516019	71,95	---	---
Volkswagen T4	> 9/1995	516803	38,95	51625	40,95	---	---	51557	77,95	516022	137,-
Volkswagen T5	> 2003	516804	44,95	51626	40,95	515804	54,-	51579	77,95	516025	137,-
Volkswagen T6.1/T6	> 2015	516805	44,95	51578	29,95	515805	37,-	51579	77,95	516025	137,-
Volkswagen T7 Multivan	> 2021	516816	42,95	516357	39,95	---	---	515713	77,95	516053	145,-
Volkswagen Crafter/MAN TGE	> 2018	516811	45,95	---	---	---	---	516026	77,95	516027	137,-
Mercedes-Benz Sprinter/ VW Crafter	2006 - 2018	51683	49,95	51634	40,95	515806	54,-	516030	71,36	51606	137,-
Mercedes-Benz Sprinter/VW LT	1996 - 2006	51683	49,95	---	---	---	---	516031	71,36	51602	137,-
Mercedes-Benz Sprinter	> 2018	516812	49,95	516039	39,95	---	---	516028	77,95	516029	137,-
Iveco Daily	> 2014	516806	36,95	---	---	---	---	---	---	---	---
Renault Trafic / Nissan NV 300 / Fiat Talento	> 2014	516801	43,95	---	---	---	---	51581	77,95	516032	116,45
Opel Vivaro B	2014-2019										
Mercedes-Benz Vito / Viano	2003-2014	516809	34,95	---	---	---	---	---	---	---	---
Mercedes-Benz Vito/V-Class/Pössl Campstar /Vanstar	> 2014	516810	34,95	516341	35,95	---	---	516033	66,26	516021	137,-
Ford Transit	2000-2013	516808	26,95	51627	40,95	---	---	---	---	---	---
Ford Transit (handbrake left)	2004 - 2006	---	---	51629	40,95	---	---	---	---	---	---
Ford Transit (handbrake left)	2006 - 2013	---	---	516351	39,95	---	---	515731	77,95	516034	137,-
Ford Transit Custom	> 2014	78098	38,95	516352	39,95	---	---	516035	77,95	516036	137,-
CitrëonSpacetourer/Jumpy/Peugeot Traveller/Expert/Toyota Proace Verso/Pössl Campster/Vanster	> 2016	516800	33,95	516353	39,95	---	---	516037	77,95	516038	137,-
Opel Vivaro C/Zafira Life	> 2020					---	---				
Fiat Scudo/Ulyssee	> 2022					---	---				

NOTE: Dimensions are adjusted for 2 single seats in the cab, not suitable for double bench seats.

CAB COVERS FOR FIAT DUCATO



Premium quality slipcover

- High quality imitation leather, colour anthracite
- For driver and passenger seat

Fiat Ducato > 2007 with foam headrest cap	943562	119,-
Fiat Ducato > 2014 without headrest cap	943563	109,-
Armrest cover >2007, 1 pair	943564	29,95



Integral slipcover Easyfit

- Cover imitation leather and microfiber
- For driver and passenger seat
- Zipper on the back pad

① imitation leather beige and grey microfiber, with headrest cap made of foam, 1 pair Fiat Ducato > 2007	943560	235,-
VW T6.1 California > 2015 (not shown)	943554	235,-
② Synthetic leather black/microfiber grey without headrest cap, incl. protectors for backrests 1 pair Fiat Ducato > 2014	943561	235,-
VW T6.1 California > 2015 (not shown)	943555	235,-

UTENSILOS/STORAGE NETS/STORAGE COMPARTMENTS



19,95



← Stretchable 33 to 66 cm →

Felt seat organizer universal with 7 pockets

- Suitable for the driver or front passenger seat
- Attaches to the armrests with elastic retaining strap and hook for attaching under the seat
- 7 pockets plus one large pocket (also suitable for laptop)

Material felt, colour anthracite, dimensions: W42 x H76 cm.

919172 19,95



Storage nets in 4 sizes

- Elastic mesh
- Quickly and easily attached

Scope of delivery: storage net, profile frame and mounting material. Black colour.

Storage net S, W 20 x H 26.5 cm	461945	12,95
Storage net M, W 27 x H 26.5 cm	461946	14,95
Storage net L, W 35 x H 26.5 cm	461947	16,95
Storage net XL, W 45 x H 26.5 cm	461948	18,95



Aluminum storage compartments

- Stable aluminum frame and elastic mesh
- Shelves are pre-assembled & can be attached directly
- 6 holes in aluminum profile for easy wall mounting

Colour aluminum frame and net: black. (Mounting material not included)

Storage compartment S, WxHxD 32.5x12x8 cm	461942	24,95
Storage compartment M, WxHxD 39x20x8 cm	461943	29,95
Storage compartment L, WxHxD 44x22.5x8 cm	461944	34,95

CAB ADDITIONAL BEDS

- Total height: 8 cm (7 cm thick cold foam mattress and 1 cm thick MDF board)
- Cover (100% polyester fabric) removable and washable
- 2-fold foldable (weight approx. 11 kg)
- Colour: Grey

Fiat Ducato (also Ducato 8), Peugeot Boxer, Citroën Jumper > 2002	421742	219,-
Volkswagen T6.1, T6, T5, T4	421743	219,-
Volkswagen Crafter, MAN TGE > 2017	421744	229,-
Mercedes-Benz V-Class, Vito Tourer > 2014	421745	229,-
Mercedes-Benz Sprinter > 2018	421746	229,-
Renault Trafic, Fiat Talento, Nissan NV300, Opel Vivaro > 2002	421747	229,-
Ford Transit Custom > 2013	421748	229,-
Citroën Spacotourer/Jumpy, Peugeot Expert/Traveller, Toyota Proace, Opel Zafira, Fiat Scudo > 2015	421749	229,-
Optional carrying bag	421750	49,95



Fig. shows Mercedes-Benz V-Class

ELECTRIC LIFTING BEDS

Complete set for Fiat Ducato, Peugeot Boxer, Citroën Jumper, Mercedes-Benz Sprinter

- Extra-light aluminum profiles (weight approx. 35 kg)
- Loadable up to max. 400 kg
- Infinitely height-adjustable
- Mechanism integrated into the frame under the slatted frame

The electric fold-down bed from CARBEST is characterized by its high-quality workmanship and intuitive assembly. It is infinitely height-adjustable. The extra light weight (approx. 35 kg) is achieved using sturdy aluminum profiles. The static load capacity is 400 kg. The height adjustment speed is 33 mm/second, with a consumption of only 6-7 A / 12 V.

The maximum stroke (travel) is 900 mm. The lifting bed is maintenance-free. Including slatted caps for the slatted frame for optimum reduction of mechanical noise while driving.

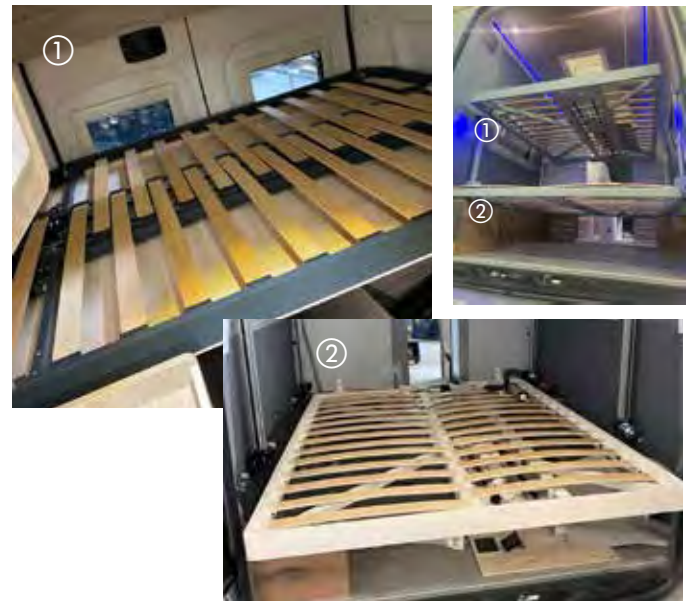

① Lifting bed with cable pull for Fiat Ducato, Peugeot Boxer, Citroën Jumper

Scope of delivery:

- 1 drop-down bed 1755 x 1325 mm
- 1 mattress 1755 x 1325 mm
- 1 trolley right / 1 trolley left
- 2 front bed attachments
- 2 bed rails
- 1 fixing point at the rear left
- 1 fixing point at the rear right
- 2 front mounting plates
- 1 electrical component (motor)

Frame colour black 93957

1899,-

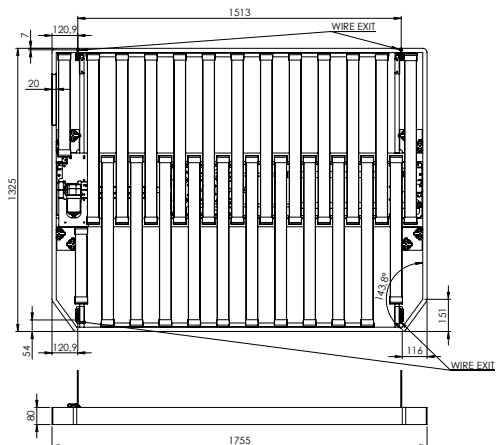
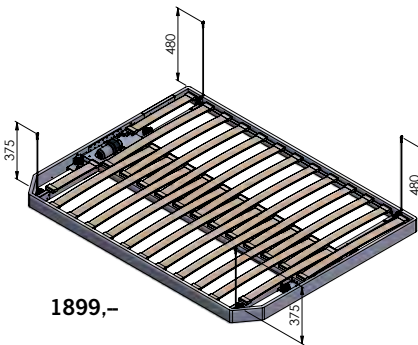

② Lifting bed with rail system for Mercedes-Benz Sprinter

- 1 drop-down bed 1853 x 1400 mm
- 1 mattress 1853 x 1400 mm
- 1 trolley right / 1 trolley left
- 1 front bed attachment on the left
- 1 front bed attachment on the right
- 2 bed rails
- 1 fixing point at the rear left
- 1 fixing point at the rear right
- 1 mounting plate front right
- 1 mounting plate front left
- 1 electrical component (motor)

93958

1919,-

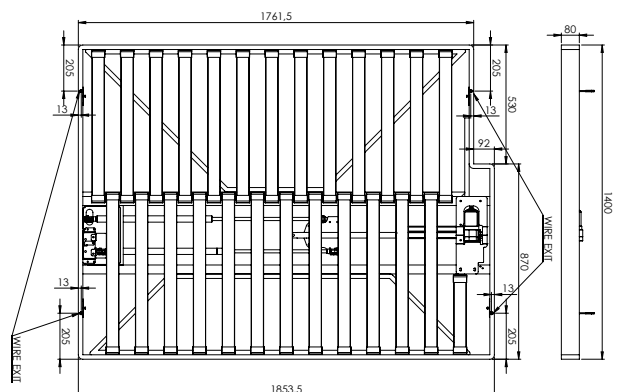
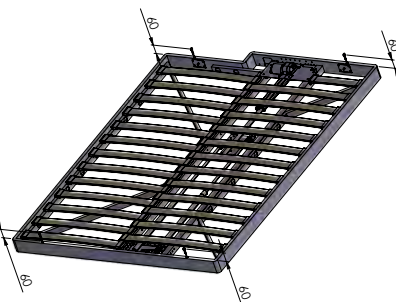

SHIMS AND COMPENSATING WEDGES

4 Pcs.



Shims with handle

for height compensation, as base for trestles or support feet, load capacity: 2.5 tons per set, material: PP (plastic), dimensions: 225 x 165 x 22 mm, weight: 0.9 kg, 4 pieces.

91186 17,90

4 Pcs.

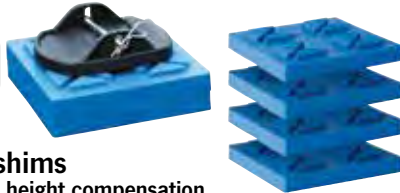

Universal shims

- 4 plates for height compensation
- Snap in anchor model

For height compensation under support trestles or support feet. Dimensions: 21 x 21 x 3.3 cm, weight 1.3 kg 4 pieces. (supplied without support plate)

91187 15,95



Plastic support plates set

- for crank supports
- is firmly connected to the supports

The set consists of 4 support plates. These prevent the crank supports from sinking in when the ground is soft. Dimensions: 18x14.5x4.5 cm. Weight: 1.3 kg.

912322 12,90

4 Pcs.

COMBINABLE



4 Pcs.

Plastic support plates set

- Can be combined with caravan pads (911951)

The set consists of 4 support plates. These prevent the crank supports from sinking in when the ground is soft. The support plates can be combined with the Caravan Pads 911951 to create even greater height compensation. Robust plastic with metal pin. Dimensions: 18x14.3x5 cm, weight: 1.1 kg.

91195 13,95



4 Pcs.

Caravan Pads - Set of plastic support plates

Stackable base for support feet. Provide a height adjustment of 40-150 mm. Ideal for uneven terrain. The Caravan Pads can be combined with the support plates 911951 to create even greater height compensation. Weight: 0.6 kg.

911951 7,95

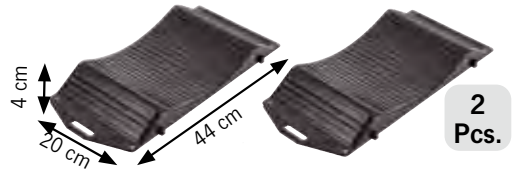

2 Pcs.

Tire protector

reduces the deformation of the wheels during long standing times. Suitable for wheels from 10" to 20". Dimensions: 44 x 20 x 4 cm, Weight: 0.9 kg.

91528 13,56

2 Pcs.

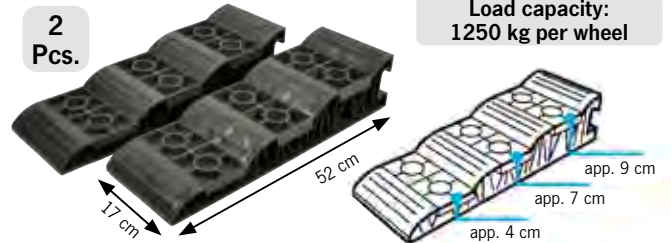

Load capacity:
1250 kg per wheel

Plastic compensating wedges

The plastic step wedges are ideal for leveling caravans or mobile homes on uneven ground. Load capacity: 1250 kg per wheel. Material: plastic, colour grey. Size: 52 x 17 x 11 cm, weight: 1.8 kg/pc.

914000 30,95

2 Pcs.

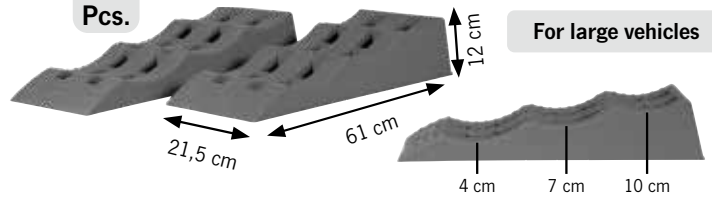

For large vehicles

Balancing wedges XL for large vehicles

XL leveling wedges are ideal for leveling large caravans or motor homes with wide tires. Loadable up to 5 t per axle. Dims: 61x21,5x12 cm, weight: 2,4 kg/pc. Material: PP. Colour: grey.

912554 29,99

2 Pcs.



Wheel brake wedges

Wheel brake wedge set incl. Wall holder, black, lightweight, made of sturdy plastic, 2 wedges in set, length: 22 cm; Height: 9,5 cm, width 9 cm. Weight: 0.5 kg.

925521 5,95

①



②



Maximum wedge size:

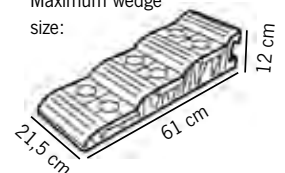

Carrying bag for drive up wedges

① With long carrying handle and Velcro closure. Suitable for drive-up wedges with a size of max. 61x21,5x12 cm. (Matching ramp wedges: 914000, 912554, 93106). Material: polyester, colour black.

912555 7,99

Wall bag for ramp wedges

② With 4 eyelets for hanging 2 drive-up wedges, e.g. in the rear garage. Suitable for drive-up wedges w/ a size of max. 61x21,5x12 cm. (Matching ramp wedges: 914000, 912554, 93106). Material: polyester, colour black.

912556 12,95

PLASTIC STEPS



Step Medium + Large

with travelmobile andnd Caravan approval.

- ① Dimensions: 500 x 345 x 230 mm, Colour: Black **912389 10,95**
- ② Dimensions: 580 x 395 x 245 mm, Colour: Black **912380 13,95**

Double step XL

Dimensions: LxDxH 700x600x370 mm. Colour: Black. Weight 4 kg. **912040 32,95**

FOLDABLE STEPS



Foldable plastic step with small pack size

With large step surface (37 x 31 cm) and non-slip surface. Height: 24 cm. Height when folded: 5 cm. Pack size 38 x 37 x 5 cm. Polypropylene. Weight approx. 2.1 kg. **91185 17,95**

Foldable aluminum step

Load capacity up to 150 kg. Dimensions when open: 60 x 48 x 22 cm. Closed dimensions: 48 x 37 x 7.5 cm. Weight: approx. 3.1 kg. **91190 69,95**



Foldable plastic step

Size: 42 x 28x 26 cm. **91194 22,95**

Foldable step made of steel

Can be loaded up to 130kg. Dimension opened: 62 x 40 x 23 cm. Closed dims: 48 x 30 x 8 cm. Weight: approx. 4.6 kg. **91184 34,90**

Foldable double step made of steel

Load capacity up to 150 kg. Step height: 20/40 cm Can be folded to save space. Dimensions when open: 50 x 40 x 59 cm. Closed dimensions: 50x82x7 cm. Weight: 5 kg. **91189 49,95**

SINGLE AND DOUBLE METAL STEPS

- Very sturdy design made of steel
- Slip resistant due to rubber pads

- ① Single steps, dims: WxHxD 380x250x390 mm. Weight: approx. 2.3 kg
Colour black **912051 27,95**
Colour silver **912031 22,95**
- ② Double step Dims: WxHxD 380x381x634 mm. Weight: approx. 4,3kg
Colour black **912050 44,95**
Colour silver **91203 39,95**
- ③ Single step with handrail, dims: W 360 x H 255 x D 440 mm. **912025 29,95**
- ④ Double step with handrail, dims: W 640 x H 375 x D 430 mm. **912026 37,95**
- ⑤ Supports for steps, dims: W 350 x D 230 mm. Weight: approx. 0.16 kg **912033 3,95**
- ⑥ Sink-in protection 4 pcs. prevents sinking in on soft ground **912039 9,95**
- ⑦ Spare cap 4 pcs. Protects the steel frame and the floor **912036 2,20**



CARAVAN ACCESSORIES



Caravan mirror, rectangular

With variable gripper arm and blind spot mirror.

Mirror glass: L 23 x H 15 cm, Projection: 40 cm,
Weight: approx. 450 g. **473004 19,95**



Caravan mirror, oval

With very sturdy bracket and dead-angle mirror.

Mirror glass: L 18 x H 12.5 cm, Projection:
25-45 cm, Weight: approx. 250 g

47346 36,95



Caravan clip-on mirror

Variable gripper arm

Mirror glass: L:15xH: 11 cm, projection:
35.7 cm, weight: 284 g

473002 19,95



Reflector, angular, clear

2 pieces, Clear. Dimensions: approx.
95 x 38 mm

468612 2,51



Reflector, angular, red

2 pieces, Red. Self-adhesive.
Dimensions: 95 x 38 mm

468611 2,51



Wide angle lens for better rear view

- Increases the field of view
- People and obstacles behind the vehicle better visible
- Risk of collision when reversing decreases
- Easy to install



Moisten the smooth side of the lens, press it onto the cleaned back window. Holds very well, can be easily removed again.

Vehicle length up to 3 m **15 x 20 cm 47105 9,95**
Vehicle length up to 5 m **20 x 25 cm 47106 10,95**
Vehicle length from 5m **27 x 35 cm 47107 17,50**

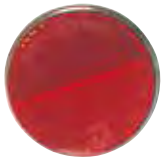

Reflector, round, red

1 piece, red, self-adhesive, Ø 72 mm

46861 2,51



Reflector, round, red

2 pieces, Red, Ø 72 mm

468530 2,51



Triangle reflector

2 pieces, dimensions: 156 x 136 mm

468460 3,95



Round wide angle mirror

- Improves visibility in blind spots
- To stick on the rear view mirror

Back self-adhesive, is simply glued to the rear view mirror. Ø 75 mm

47102 4,99



12V

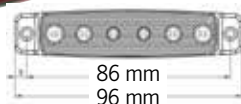

CARBEST par **ESANEL**
AUTO ELECTRONIC

12V LED side marker lights

- Very small and compact
- Simple surface mounting suitable for indoor and outdoor use
- Economical LED technology
- ECE-tested

Particularly small & compact LED side marker lights. Suitable for indoor use (rear garage, storage compartments) and outdoor use. Operating voltage: 12 V, 6 x 0.06 W LEDs, 30 lumens. Dims.: LxW 96x10 mm.

Colour yellow **469500 9,95**
Colour white **469502 9,95**
Colour red **469501 9,95**

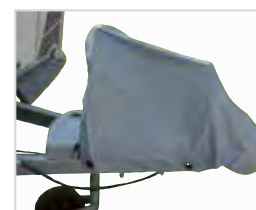

Drawbar protective cover

Made of weatherproof PVC including protective bag. Dimensions: 86 x 60 cm. With sturdy fastening straps. Suitable for all common drawbars

90508 8,95



For caravan and trailer

Drawbar impeller Ø 48 mm

Telescopic. Sturdy design with steel rim. Loadable up to 200 kg.

① **With solid rubber wheel**
200 x 50 mm
927741 25,95
② **With pneumatic tires**
260 x 85 mm
92774 33,95

CARAVAN ACCESSORIES

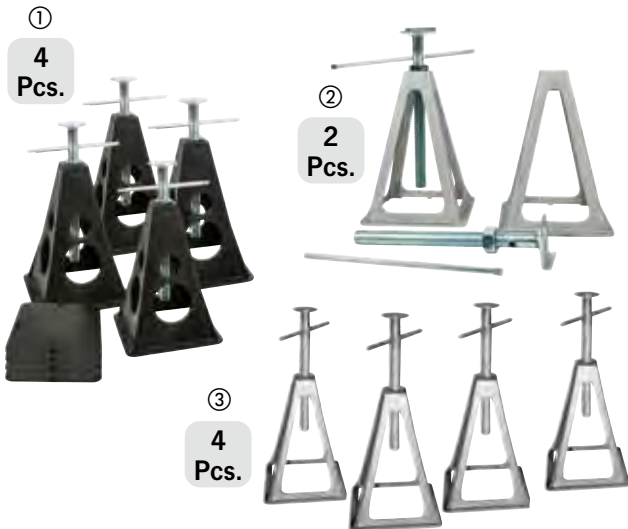

Support trestles for motorhomes and caravans

① **Support trestle set 8-piece plastic, black** Set consisting of 4 support trestles and 4 shims (plastic). Height 30-42 cm, load capacity: 750 kg per trestle. With metal spindle. Stackable. Weight: 0.5 kg.

912064 42,95

② **support frame set 2-piece aluminum** Secure stand of your caravan, motor home or trailer. Height: 28-43 cm, load capacity: 1000 kg per trestle. With metal spindle. Stackable. Weight: 0,8kg.

912060 24,90

② **support frame set 4-piece aluminum** Secure stand of your caravan, motor home or trailer. Height: 28.5-42 cm, Load capacity: 1000 kg per trestle. With metal spindle. Stackable. WxH approx. 16x23 cm. Weight 3.2 kg.

912061 49,95

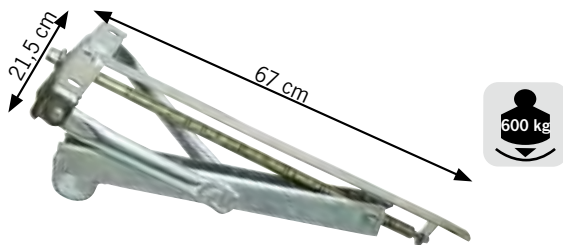

Galvanized universal crank support

• **Static load capacity 600 kg per support**
Unscrewing length: 497 mm, Weight: 3.5 kg.

912323 47,90



① **Spirit level** With magnetic strip and 3 vials, material: PP+TPR.

912000 4,95

② **Caravan scale** with 2 vials, magnetic.

912271 3,95

③ **Double spirit level** with 2 spirit levels, magnetic.

Dimensions: 100 x 20 x 45 mm. 912181 5,95

④ **Circular spirit level**

1 spirit level round Ø 30 mm. 91217 8,30

⑤ **Spirit level level**

Assorted colours in orange and black, Dimensions: 100 x 35 x 12 mm.

912185 7,50

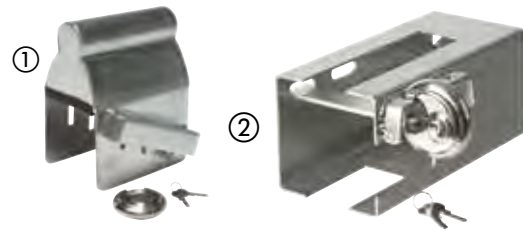

Box fuses

① **Box lock for the caravan/trailer**

Secures coupled and uncoupled caravans or trailers against theft. Sturdy sheet steel housing with discus security lock and 2 keys.

913611 19,95

② **Box locks for the uncoupled caravan/trailer**

Sturdy sheet steel housing with discus security lock and 2 keys.

91361 19,99

Clamp for the jockey wheel

48 mm 92778 7,90



Universal U-lock

For securing couplings with 2 keys. Weight approx. 2 kg.

92763 25,95



Safety eyelet

For attaching the breakaway cable. Can be screwed to coupling, subsequent assembly possible. Required in the Netherlands, Austria and Switzerland.

913671 10,95



Breakaway rope

For caravans and braked Trailer, mandatory.

91367 4,40



Aluminum support load scale

Material: aluminum, plastic base. Weighing range 50 to 100 kg.

912250 15,95

Digital support load scale

Continuous measurement acquisition during charging. Easy to read display. Remains precise even after long use. Measuring range up to 150 kg.

912258 29,95



Support load scale

For all trailers with Ball coupling. Weighing range 50 to 100 kg.

91225 11,95



PRACTICAL CAMPING ACCESSORIES



Elegant Optics

Pietro fan heater in a stylish design

With 2 power levels: 750/1500W, 230V. 12h timer and LED display. Automatic tilt protection - immediately switches off the power supply if it falls over. Temperature controller and overheating protection.
Dimensions: W220 x H290 x D120 mm, weight approx.: 1.8 kg. **811527 52,95**



Ivalo ceramic fan heater

With 2 power levels: 750/1500W, 230 V. Self-rotating (oscillating). With overheating protection and automatic tilt protection - immediately switches off the power supply if it falls over. Dims: H260 x W200 x T130 mm **811522 32,95**



Compact Design

Ceramic fan heater Mika

• 2 functions: Heating/ventilation
• Double overheating protection
• Quiet operation
With 2 power levels: 750/1500W, 230 V. Heating or ventilation can be switched on. Adjustable thermostat for temperature control and adjustment. Automatic tilt protection - immediately switches off the power supply if it falls over. With operation indicator. Safety ceramic heating element. CE approved. Approx. dims: BxHxD 215x220x223 mm, Weight approx.: 2 kg **811525 37,95**



230 VOLT **700 WATT**

230 volt hair dryer

- With foldable handle, compact storage
- With eyelet for hanging
- Slot attachment included

230V - Hairdryer with 700 W power, which can be regulated in 2 levels. Dims: L16 x W 7 x H 16 cm, pack size: 19 x 11 x 7 cm. Weight 0,35 kg **804199 12,95**



NEW 2024
12 VOLT

210 WATT

12 V hair dryer

- For 12V cigarette lighter
- Foldable handle
- Cable 1.4 m

Dimensions: opened 15.5 x 6 x 11.8 cm / folded 9.5 x 6 x 11.8. Weight: app. 0.3 kg **804195 17,95**



12V

12V fan

Cable length 2.5 m, with Clamp holder
Ø fan: 18 cm, mounting with clamp. Approx. dimensions H 25cm, D 20 cm. Material: PP / metal. Weight 0.7 kg. **462880 20,95**



NEW 2024

Cordless vacuum cleaner

- Charging option 230V + USB
- 2 levels adjustable

Cordless vacuum cleaner w/ 200 W power & bagless stainless steel filter, which can be opened at the touch of a button & is therefore easy to empty. 14.8V 200 W motor, running time max. 30 min, 2 levels.

Round tube, floor brush, crevice nozzle, upholstery nozzle, round brush incl. 230V charging station & USB charging cable
Dims.: L 45.5 x H 10.5 x W 6.5 cm, weight: 0.8 kg, colour: silver-grey **804276 99,95**



NEW 2024

12V Vacuum cleaner

- 4m cable
- Extensive accessories
- Filter can be completely removed
- Easy to clean
- No dust bag required

The 12V vacuum cleaner in a new modern design. Completely removable filter for easy cleaning. Extensive accessory package included: exten-

sion tube, floor attachment, crevice nozzle, round brush, mattress/ upholstery brush.
Power: 150 W / 4.0kPa
L 40 x H 14 x W 10.5 cm, weight: 1.3 kg, material: ABS + PC / Filter: stainless steel + PU foam, colour: black **804275 42,95**

PRACTICAL CAMPING ACCESSORIES

Gas cylinder level indicator

- Measurement of one or two gas bottles
- Bluetooth transmission to smartphone/tablet or display module
- Free app

1 bottle system for smartphones/tablet

Conveniently determine the filling level of your gas bottle via your smartphone. You can download the free app on your mobile device via QR code. The included sensor displays the level of your gas bottle via Bluetooth on your smartphone. Includes 1 sensor. (Smartphone required) **75302** **72,-**

2-bottle system including display module The CARBEST level indicator including display module determines the fill level of two gas cylinders simultaneously. The display module informs you at an early stage about the upcoming gas bottle change. Includes 2 sensors. (no smartphone necessary) **75303** **166,50**



Car door step with folding hook

- For easy access to the vehicle roof
- Ideal for loading or cleaning vehicle roof
- Loadable up to app. 120 kg
- Structured tread surface for non-slip standing
- Rubber lip prevents scratching of car paint
- Compact storage thanks to folding hooks

Material: Metal, powder-coated. With rubber lip to protect vehicle paintwork. Colour: black, dims.: LxWxH 161x76x16/84 mm, weight: 0.3 kg.

900060 **14,95**

Compact aluminum folding ladder with max. 2,10 m length

Lightweight aluminum and yet loadable up to max. 150 kg. With 6 levels. Dimensions opened: 210x45x6 cm, dimensions closed: 210x6x6 cm. Weight approx. 3.8 kg.

44005 **89,90**



Escali - Multifunctional ladder max. length 3.2 m

- 11-stage, extended height max. 3.2 m
- Ideal for loading the roof box or cleaning the caravan and motorhome
- Compactly foldable, fits comfortably in the trunk or in the rear garage
- Loadable up to max. 150 kg, weight app. 9.1 kg
- Working height approx. 4.2 m
- Approved according to EN 131-6

Safety note: According to TÜV regulations, must the Escali Multifunctional Ladder protrude 70 cm above the stop edge! Packing size: H ca 77 cm, W ca 44/46 cm

440130 **169,-**



10 SPIRALS + 2 HOLDERS

Maik - Battery Insect Killer Insects are attracted by the light and electrocuted when they touch the grid. With 4 watt fluorescent tube & 230 V charger. Battery charging time 9 hours / battery running time 7 hours. Dimensions 19 x 9x 27 cm. Weight 2.2 kg. **903911** **12,71**

Anti-mosquito spiral

The smell of the glowing fragrance spiral repels insects. Glow time per spiral 5-6 hours. Scope of delivery: 10spirals and 2 holders. To be used outdoors only. **90390** **3,95**

PRACTICAL CAMPING ACCESSORIES



Safety - Transportable safety cassette

Safety can be quickly inserted or removed at any time thanks to supplied, firmly screwed mount. Cassette is firmly connected to holder by means of a lock tongue. Dims.: holder app. W16 x D22 x H7 cm, cassette app. W15 x D21.5 x H6 cm. Weight: 1.7 kg. Scope of delivery: Safebox, holder, 2 keys, security chain, mounting material.

47132

24,95



Rex - Versatile furniture safe

- Solid steel body and door
- Double bolt locking (Ø 16 mm)
- Including 2 double-bit keys

For installation in cabinet or bookcase, in caravan, motorhome, yacht or office. Right-hand door hinge with concealed hinges. Weight: 6.8 kg. External dimensions: approx. W31 x D20 x H20 cm. Scope of delivery: safe, 2 keys, fixing material.

47136

49,95



Tailgate opener - ventilation despite locking

- Close & lock the tailgate except for ventilation gap
- Tailgate can no longer be opened from outside in this state
- Easy to install, no tools required
- Made of solid, powder-coated metal

Suitable for the following vehicles: Volkswagen Caddy (2003-2020), Volkswagen Transporter 6/5/4, Mercedes-Benz Vito (> 2003), Mercedes-Benz Viano (2003-2014), Ford Tourneo Custom (> 2013).

46309

19,95



12V Compressed Air Compressor

Premium metal compressor for car tires, floats and inflatable boats. Also suitable for larger RV tires. 12V compressor with 360 W, pressure 10 bar/150PSI power and 72 l delivery volume per min. Integrated thermal protection switch and robust metal housing. With transport bag and valve attachments. With battery terminals for direct connection to the battery.

474081

99,90



Wheel claw steel

Theft protection for cars and trailers. Steel wheel claw for wheels up to 26.5 cm wide. Scope of delivery incl. 2 keys. Dimensions: approx. 23 x 50 cm, weight: approx. 2.3 kg.

913401

37,95

230V



Camping washing machine Fay 230 V/140 W

- 1.8 kg capacity
- Compact and easy to store

The timer allows you to select the washing time depending on the material and level of dirt. The lid spring system makes it easier to fill and empty the machine. Drum and housing made of polypropylene. Practical carrying handle at the rear. Incl. Filling hose. Weight approx. 5 kg.

91913

89,95



Reserved sign

To be placed on the campsite. For motorhomes and caravans. Material: plastic. Dims: 61.5 x 30 cm.

47085

24,90



Step mat

- For manual and electric treads from Motorhomes or caravans
- Quick assembly, easy cleaning, durable

Suitable for treads from 38 x 40 cm to 45 x 40 cm. Reliably protects your interior from dust and dirt. Includes 2 springs for mounting. Colour: Black, Weight: 0.18 kg

516100

14,99

CONVERSION PRODUCTS

Rolling door complete set

- For the construction of a roller shutter door opening upwards
- For maximum door size of 100 cm height and 60 cm width
- Enables opening even in confined spaces
- Complete with cut to size roller shutter, rails and screen

The guide rails, roller shutter mat and retractable panel can be cut to the desired door dimension and cabinet depth. Material: plastic.

Roller shutter door set consisting of:

1 x Roller shutter mat with handle, H 100 x W 60 cm, 4 x Guide rails for screwing on, L 100 cm, 4 x guide bends 90° for screwing on 1 x retractable screen, L 100 cm

Colour black matte	53047	89,90
Colour silver	53044	102,-
Colour beige, textured	53045	102,-

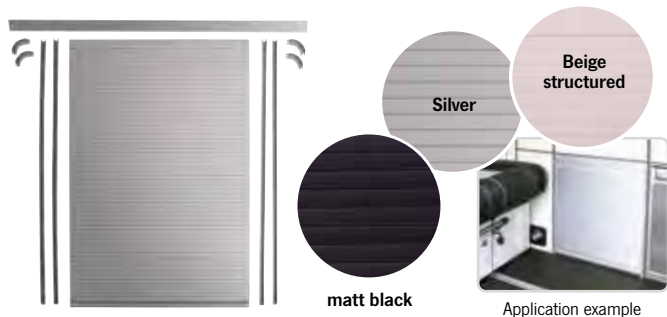

Rolling door for bathroom and WC rooms

Silver colour plastic shutter door with handle on both ends. Height max. 200 cm, width max. 120 cm, each can be shortened. Slat width approx. 32 mm.

Scope of delivery:

Slatted door, floor glides, 2 x 90° guide rails (100/20 cm) each for top and bottom, 2 m magnetic tape, assembly instructions

Roller shutter door H200 x W120 cm,
53046 282,-

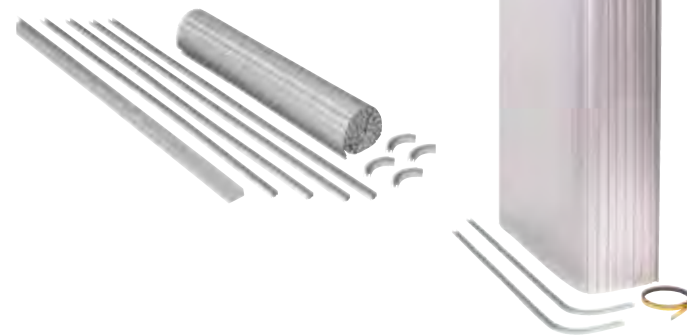

Lifting table frame, height-adjustable

- Folding mechanism
- Simple height adjustment
- Fixation to the floor possible
- Loadable up to max. 100 kg

Lifting table frame in black, w/ folding mechanism by operating lever. Allows easy height adjustment from table to bed frame. Can also be fixed to the floor. Length: 60 cm, foot width 59.3 cm, height: 30.3 cm / 70.3 cm, weight 8.5 kg. Scope of delivery: lifting table frame (without table top), incl. floor fixation

57011 135,-



Picnic table assembly

- For mounting on the outside wall of the vehicle
- Mounting frame with fold out picnic table
- Dimensions table top: 715x365 mm
- Loadable up to max. 30 kg

The mounting frame with fold-out picnic table is mounted on the outside wall of the motorhome or caravan. Table top dimensions: LxW 715x365 mm, overall dimensions incl. mounting frame: LxWxD 800x450x25 mm. Table top made of anodized aluminium (colour black), mounting frame material: Plastic (colour white) Scope of delivery: picnic table with mounting frame, mounting material. Weight: approx. 5kg.

30009 199,-



12V stainless steel exhaust hood

Stainless steel housing, with lighting 2 x 1.5 W LED (2 x 80 lumens), Warm white (3000 Kelvin), suction power 98 m³/h, 12 V, only for Motorhomes and caravans. Dimensions: W 46 x D 28 x H 5 cm. Weight 1,8 kg

31852 169,-



WARRANTY CONDITIONS

We provide a manufacturer's warranty for all products offered under the following Reimo brands:

“CARBEST” / “REIMO TENT” / “MC CAMPING” / “CAMP4” / “HOLIDAY TRAVEL”

WARRANTY CONDITIONS:

Reimo Reisemobil-Center GmbH, Boschring 10, D-63329 Egelsbach (hereinafter referred to as “Reimo” or “we”), provides a three-year warranty on the products sold under its own “CARBEST”, “REIMO TENT”, “CAMP4”, “MC CAMPING” and “HOLIDAY TRAVEL” brands in addition to the statutory rights related to defects.

By way of derogation from the above, Reimo provides a seven-year warranty on LiFePO4 lithium batteries sold under its own “CARBEST” brand and a five-year warranty on those sold under its own “MC CAMPING” brand. In addition, Reimo provides a 25-year warranty on rigid solar panels with aluminium frames sold under the “CARBEST” brand and a 20-year warranty on those sold under the “MC CAMPING” brand.

The warranty period will start to run on the relevant invoice date. The geographical scope of our warranty extends to the territory of the Federal Republic of Germany.

If any material defects or manufacturing defects are found in your purchased products during the warranty period, we will provide you with one of the following services at our discretion as part of the warranty:

- **We will repair the goods free of charge; or**
- **We will exchange the goods for an equivalent product free of charge.**

Reimo will acquire ownership of any original parts that are replaced within the scope of the above warranty services. You will acquire ownership of the new parts or replacement parts.

Any repairs or replacements provided under the warranty will not entitle you to extend or restart the relevant warranty period.

If you wish to make a warranty claim, please contact the dealer from whom you purchased the product in question or Reimo directly as the warrantor:

Reimo Reisemobil-Center GmbH
Boschring 10
D-63329 Egelsbach
Tel.: +49 6150 8662-310

The warranty will not apply if any defects other than material defects or manufacturing defects are found. Furthermore, warranty claims will be rejected if any damage is caused by:

- **normal wear and tear;**
- **improper and non-intended use of the product;**
- **improper operation, installation, assembly, commissioning or operation contrary to the relevant instructions for use and/or installation, especially if instructions for maintenance and care or warnings are not observed;**
- **failure to observe any safety precautions;**
- **use of force (e.g. beating);**
- **self-repairs;**
- **use of any non-original parts or any parts not approved by the manufacturer;**
- **environmental factors (e.g. heat, humidity);**
- **circumstances for which the manufacturer is not responsible (e.g. natural disasters, accidents); or**
- **improper transportation.**

In order to make a warranty claim, you must allow us to examine the case in question (e.g. by sending us the goods). Please use secure packaging to ensure that the goods are not damaged during transport.

In order to make a warranty claim, you must enclose a copy of the invoice with the shipment of the goods. This will enable us to check whether the warranty conditions are met. If you do not enclose a copy of the invoice, we may refuse to provide services under the warranty.

If your warranty claim is legitimate, you will not incur any shipping costs (i.e. we will reimburse you for any shipping costs incurred to send us the goods. Includes shipping within the Federal Republic of Germany only).

Please note:

This manufacturer's warranty provided by Reimo will not restrict any statutory warranty rights that you may be able to assert against Reimo / a dealer in the event of defects; you may exercise the relevant rights free of charge.

This manufacturer's warranty shall have no bearing on any statutory warranty rights that you may hold against Reimo. On the contrary, this manufacturer's warranty serves to consolidate your legal position.

If any of your purchased items are defective, you may always assert your statutory warranty rights against Reimo, regardless of whether the defects are covered by the warranty or whether a claim is asserted under the warranty.



(Last updated: March 2024 / Rev.1.5_03.2024)

954122



REIMO REISEMOBIL-CENTER GMBH
BOSCHRING 10 - 63329 EGELSBACH - GERMANY - www.reimo.com

CARBEST IS A REGISTERED TRADEMARK OF THE COMPANY REIMO REISEMOBIL-CENTER GMBH.
Copyright: Reimo Reisemobil-Center GmbH. Delivery subject to change. All products without decoration.
Misprints, errors and subject to technical modifications/developments. All data without guarantee.
The permissible tolerance for technical Specifications is +/- 5%. Fig. partly show extras and decorations that are not included.
All prices in Euro incl. VAT. All rights reserved. Reprinting and use in electronic media, including excerpts, only with the express
express permission of Reimo Reisemobil-Center GmbH, Egelsbach. **Status 05/2024.**