



TENTS + AWNINGS 2024

FOR MOTORHOMES,
CAMPER VANS + CARAVANS

www.reimo.com

- + Processing of high quality and durable materials
- + Innovative product developments for more than 25 years
- + Large selection of suitable accessories

CONTENT

TENTS FOR CARAVANS	3
Caravan sun canopy/sunroofs	4 - 7
Inflatable partial caravan tents	8 - 13
Caravan winter/all-season tents	15 - 19
Protective roofs/floor skirts	20 - 21
TENTS FOR CAMPER VANS AND MOTORHOMES	22
Sun canopies for mini campers and small buses	22 - 28
Sun canopy and awning tent in one for camper vans	26 - 27
Privacy screen/sun canopies for tailgate/rear door	29
Tailgate tents for Volkswagen Caddy, T5/T6/T6.1 and minicamper	30 - 37
Universal tailgate tents for buses and off-road vehicles	38 - 39
Awning tents for Volkswagen and minicamper	40 - 43
Inflatable, universal bus & motorhome awning tents	44 - 47
Inflatable motorhome awning tents	48 - 51
Roof tents for cars, buses and off-road vehicles	52 - 55
Pavilions/party shelters	56 - 57
Camping tents	58 - 59
Shower tents/equipment tents/kitchen tents	59
Wind protection/visual protection	60 - 61
Pitching poles/tent poles	62
Awning accessories/tent fastenings	63 - 64
Wind protection and protective covers	65
Awning carpets	66 - 70
All-purpose tarpaulins/floor tiles/accessories	71
Camping tent know-how	72 - 73



Tents for caravans





① Awning
149,-

② Side wall
99,-



Palm Beach/Palm Beach Quick – sun canopies

- Dome roof against water pockets
- Roof with 2 diagonal fiberglass poles
- Generous sense of space
- Double piping Ø5+7 mm and tunnel

Chic and robust sun awning for your caravan with sewn-on keder profile, suitable for VW Transporter with Multitrail or similar keder rail. The two supplied set-up rods and two diagonally running fiberglass rods, provide a stable arching of the sun canopy upwards. This prevents the formation of a water bag in the dome roof.



Palm Beach sun canopy

- Small pack size
- Pockets with Velcro in the corners for easy insertion of the fiberglass rods
- Color: Light grey//anthracite//lime-green

① Palm Beach 2 - 2.6
width 260 cm

Scope of delivery: Sun canopy, 2 fiberglass poles, 2 poles, pegs, guy ropes & packing bag
900151 149,-

Palm Beach 2 - 3.0
width 300 cm

Scope of delivery: Sun canopy, 2 fiberglass poles, 3 pitching poles, pegs, guy ropes & packing bag
900152 169,-

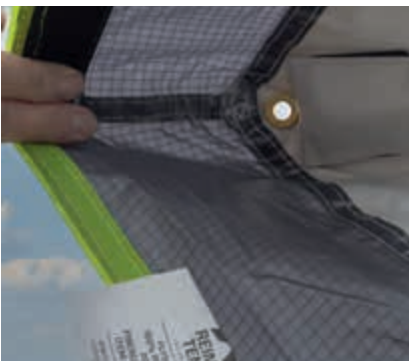

Spare fiberglass rods (2 pieces)

for Palm Beach 2 - 2.6 (900151)
900148 19,95
Palm Beach 2 - 3.0 (900152)
9001481 19,95



Photo shows Palm Beach Quick

Palm Beach Quick sun canopy

- With quick assembly system
- Can be opened with 1 handle
- Fixed fiberglass rods
- Color: light grey/anthracite

Palm Beach Quick 2.6 width 260cm

Scope of delivery: Sun canopy incl. 2 fiberglass poles, 2 poles, pegs and guy ropes, carrier bag.

900159 169,95

Palm Beach Quick 3.0 width 300cm

Scope of delivery: Sun canopy incl. 2 fiberglass poles, 3 poles, pegs and guy ropes, carrier bag.

900169 189,95

Palm Beach/Palm Beach Quick – Side walls

- Suitable for all Palm Beach sun canopies
- Window with mosquito net and cover inside
- Simple attachment to the roof with Velcro
- Mountable on both sides

2 Palm Beach - Side wall

narrow width for unhindered opening of the sliding door. Width 225 x height 180 cm, weight app. 2,2 kg

900153 99,-

3 Palm Beach Space - side wall

Height of 200 cm allows further extension for more space under the sun canopy. Width 225 x height 180 cm., weight app. 2,2 kg

900154 109,-



Model	Dimensions	ca.	ca.	Art.No.	Price
Palm Beach 2 - 2.6	B 260 x T 240 cm	Ø16 x 74 cm	5,5 kg	900151	149,-
Palm Beach 2 - 3.0	B 300 x T 240 cm	Ø18 x 74 cm	6,8 kg	900152	169,-
Palm Beach Quick 2.6	B 260 x T 240 cm	Ø11x 186 cm	5,5 kg	900159	169,95
Palm Beach Quick 3.0	B 300 x T 240 cm	Ø11 x 202 cm	6,8 kg	900169	189,95

Awning/Sun canopy for caravans



Size 8 Light gray



Size 4 Anthracite

Como - The universal sun sail

- Extremely tear-resistant
- Weatherproof and washable
- With 5+8 mm piping connection

Very sturdy awning made of Oxford polyester 210D for sizes 1 - 3, from size 4 300D in light gray or anthracite with gray edging.

Scope of delivery: Awning, sizes 1 and 2 with two poles, from size 3 with three poles, pegs and guy ropes.

Light gray - Depth 240 cm

Size. 1	200 cm	2,5 kg	90020	79,90
Size. 2	250 cm	3,0 kg	90021	89,90
Size. 3	300 cm	3,5 kg	90022	99,90
Size. 4	350 cm	4,0 kg	90023	109,90
Size. 5	400 cm	4,5 kg	90024	129,-
Size. 6	450 cm	5,0 kg	90025	139,-
Size. 7	500 cm	5,5 kg	90026	159,-
Size. 8	700 cm	7,5 kg	90019	159,-
Size. 10	900 cm	8,5 kg	90017	189,-

Anthracite - Depth 240 cm

Size. 2	250 cm	3,0 kg	900212	89,90
---------	--------	--------	--------	-------

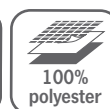
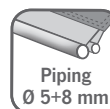

Mauritius - Awning for caravans with high variability

- Shade for large and small vehicles
- Loops for fastening with suction cups and piping Ø 5 + 8 mm

The downward-tilting side sections provide additional light or privacy protection. Material 300D RipStop polyester. Color light grey.

Scope of delivery: Awning, adjustable steel poles up to max. 220 cm: 2 pieces for Mauritius M and L, 3 pieces for Mauritius XXL. 6 pegs, 6 guy ropes in a practical pack sack.

① Mauritius M	900575	131,-
② Mauritius L	900573	152,-
③ Mauritius XXL	900572	179,-

RE-TENT the new collection from Reimo TentTechnology to protect our nature.



The tent fabrics are made from recycled disposable plastic bottles. Each m² is roughly equivalent to 3 x 5 l plastic cola bottles or 9 x 550 ml plastic water bottles.

The tried and tested Mauritius awning is available in the existing 3 sizes in the RE-TENT collection. All properties see left. New material 300D recycled Oxford polyester. Color gray.

① Mauritius 460 (RE-TENT Collection)	900576	149,-
② Mauritius 510 (RE-TENT collection)	900577	174,-
③ Mauritius 560 (RE-TENT collection)	900578	199,-

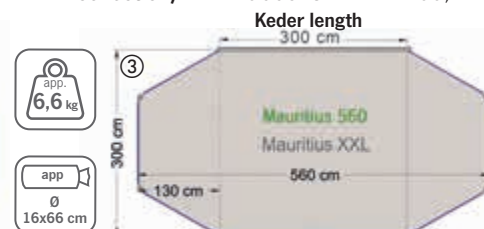
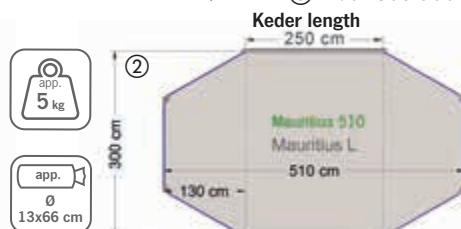
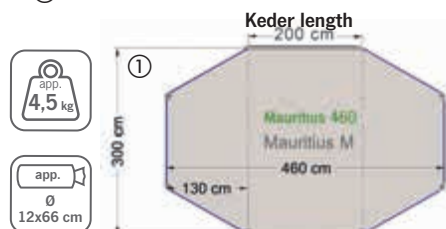



Sun canopies/sunroofs for caravans

Universal air awning Playa Air 300 & 400 Caravan

Mounting height: 235 - 250 cm

- Awning with air technology
- Quick assembly and dismantling
- Low weight
- Side panels can be removed with a zipper
- Storm bracing with click lock
- Setup with just one air hose
- Connection w/ keder profile Ø +7 mm

Scope of delivery: Awning, air tube, 2 side walls, air pump, ground pegs, storm bracing, guy ropes, carrying bag.

Width 300 cm 906887 339,-
 Width 400 cm 906888 379,-

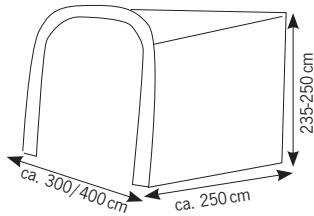

Piping Ø 7 mm	150D Oxford polyester	UV protection 50+	2.000 mm
Flame retardant	Airtube	app. 7,0 kg/ 7,5 kg	app. 77 x Ø 17 cm



Universal awning Playa Caravan 325

Mounting height: 245 cm

- Universal awning
- With large side windows
- Quick assembly and dismantling
- Low weight
- Structure with only one fiberglass rod
- Connection with Ø 7 mm piping profile

Scope of delivery: Awning, fiberglass and steel poles, ground pegs, guy ropes, carrying bag.

Width 325 cm 906882 159,-

Piping Ø 7 mm	185T, 68D polyester	UV protection 50+	1.000 mm
Flame retardant	Fiberglass + steel	app. 6 kg	app. 77 x Ø 17 cm

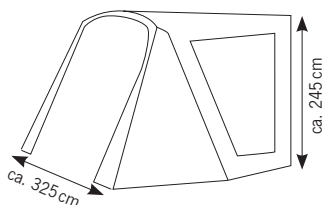



ADRIA ACTION AIR SUNSAIL



from 599,-



Adria Action Air 391 – Air sun sail

- Front and side walls completely removable, can also be used as an awning
- Mosquito net front available separately

The sun sail was specially developed for the Adria Action 391 caravan. It is quick and easy to set up and take down thanks to just 1 high-quality TPU air hose. The front wall has a door and, like both side walls, a large window with inner cover.

The side walls each have floor ventilation with mosquito net. The front and sides are completely removable with a zip.

This means that this product can be used as sun protection and also as an awning.

The scope of delivery includes 3 aluminium roof reinforcement poles with quick-release clamps and an additional reflective storm guy rope.

Scope of delivery: Tent, air tube, air pump, 3 roof poles (aluminum), storm guy ropes, guy ropes, pegs, packing bag.

936689 599,-

Optional accessories:

The mosquito net front, which is simply pulled in with a zip, is optionally available to protect against insects.

① Mosquito net front 936690 49,99

Matching awning carpet (shown in the photos):

Villa Stripe grey 2.5x4.5m, PP, incl. bag 905172 84,95



Roof reinforcement bar with quick-release

Storm bracing included

- Piping 07mm
- 210D Oxford Polyester
- Ripstop polyester 190T
- UV protection 50+
- 3.000 mm
- Flame retardant
- 1x Airtube
- app. 14 kg
- app. 75x 45 x 35 cm

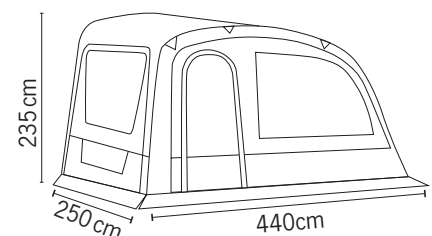



Mounting height: \updownarrow 235 - 250 cm

Adria Action Air – Inflatable awnings for the Adria Action 361 and 391

- Quick and easy to assemble
- Windows with mosquito nets
- Front door can also be used as an awning
- Removable base included
- Wind screen against draughts

Fits perfectly with the curve of the outer wall. Side windows are fitted with mosquito nets and roll-up covers. The front, with 2/3 transparent PVC window and 1/3 mosquito net, can be rolled up or used as an awning. The removable base is included.

Scope of delivery: Tent skin, 1 TPU air tube, 3 roof reinforcement poles, 2 pitching poles, tent floor, wind skirt, guy ropes, steel pegs, air pump, packing bag.

Adria Action Air 361 936680 799,-

Adria Action Air 391 936688 849,-



side windows with mosquito nets

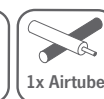
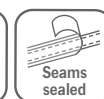



RIMINI AIR II



from **639,-**

i Casa Air II for motorhomes can be found on page 48



Mounting height: 235 - 250 cm

Rimini Air II

- Premium TPU air hoses
- Easy to set up thanks to 4 separate air hoses
- Transparent windows
- The front sections can be rolled up or set up as an awning
- Particularly stable thanks to combination of air columns and aluminum reinforcement bars
- Including wind deflector, pressure bar and foam bead



Included foam bead and support bar for secure attachment to the caravan



The tent is particularly durable thanks to replaceable double air tubes. The front consists of 3 segments with large transparent windows. The side sections are fitted with mosquito netting for good ventilation. All windows have an interior cover to protect your privacy.

Fcolor: light grey and dark grey

Scope of delivery: Tent skin incl. air tubes, air pump, pitching poles, pressure poles, foam bead reinforcement poles, wind flap, guy ropes, pegs, stuff sack

900034 639,-

Optional accessories:

Tent floor 9000342 49,95

Inner tent, 230 x 130 cm 9000341 52,50

Spare air hose 9000343 59,95

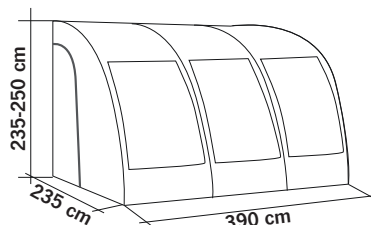
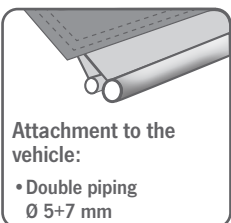



ONE BEAM AIR



One Beam Air 220

Mounting height: 235 - 250 cm

One Beam Air in 3 sizes - Large front with mosquito net

- With only 1 air hose for quick assembly and disassembly
- Front and sides with mosquito net for ventilation and protection against insects
- Low weight
- Wind screen, pressure poles and storm bracing included

Inflatable caravan awning with just 1 air hose (TPU Ø 10 cm) for quick assembly and disassembly. Both side doors & the large front door are fitted w/ mosquito netting & transparent windows.

Scope of delivery: Tent with air tube, pegs, 2 pitching poles, 2 pressure poles, wind flap, guy ropes, storm guy ropes, air pump, carrying bag. Width 325: 1 roof reinforcement (TPU)

Width 220 cm	935397	299,-
Width 260 cm	935398	339,-
Width 325 cm	935399	429,-

Replacement air hose:

For width 220	9353971	59,95
For width 260	9353981	64,95
For width 325	E26607	79,95
Roof reinforcement for width 325	E26608	34,95



One Beam Air 220

You can find matching awning carpets from page 66 onwards

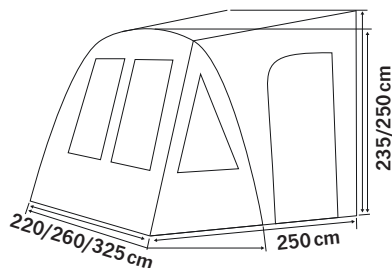

Piping Ø7mm	100% polyester 185T	3.000 mm	Flame retardant	app. 11 kg Width 220
UV protection	Airtube	app. 115 x 25 x 30 cm	app. 12 kg Width 260	app. 13 kg Width 325



MARINA AIR



from **699,-**

Foam padding and pressure bar



Including mosquito net windows

Mounting height:
235 - 250 cm



Marina Air in 3 sizes

- Quick and easy to assemble
- Both side walls with doors & mosquito net
- Including mosquito net windows in the front
- All front sections can be removed or used as awnings
- Window with veranda function
- Interior window covers
- Incl. Foam padding with pressure bars
- Including wind screen for attachment to caravan

Awning for caravans with air technology. All the windows can be opened, so you sit almost like on an airy veranda. Foam bead with steel rod for pressing onto the caravan. Floor as a "frame" under air hoses for quick assembly.

Scope of delivery: Air tubes, mosquito net window, wind screen, tensioning poles, pegs, guy ropes, air pump, carrying bag, set-up poles, foam padding and pressure poles

Storm reinforcement

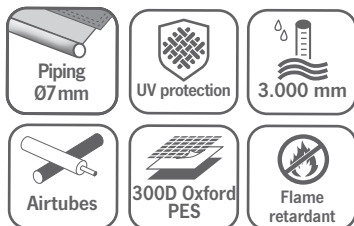

Model	app.	app.	Item no.	Price
Marina Air 290 2 segments and 3 air hoses	20 kg	70 x 44 x 40 cm	93702	699,-
Marina Air 390 3 segments and 4 air hoses	24 kg	78 x 45 x 44 cm	93703	799,-
Marina Air 490 4 segments and 5 air hoses	28 kg	78 x 55 x 50 cm	93704	899,-

Replacement air hoses:

Outside (left+right)	E26606	49.95
Center	E26605	49.95

Matching awning carpets from pg. 66 onwards

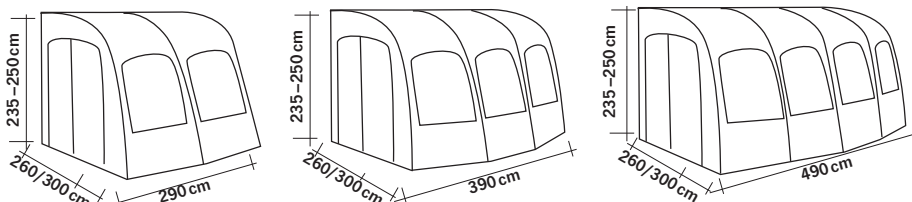



TAVIRA AIR



Mounting height:
235 - 250 cm



Tavira Air 390, 490 and 590

- One-point inflation system
- Additional roof reinforcements
- High-quality TPU air hoses
- Can be used as a year-round tent
- Top ventilation with external cover
- Large transparent front windows with inner covers
- Doors on both sides
- Side walls with large mosquito net windows with outer cover
- Incl. Foam bead and pressure bar

Scope of delivery: Tent skin, single-point inflation air poles (TPU), 3 roof reinforcement air tubes (TPU), wind skirt, guy ropes, pegs, air pump, packing bag, foam padding and pressure poles.

Optional accessories:

Inner tent (200 x 140cm)	938262	69,95
Tavira Air 390 groundsheet	938261	49,95
Tavira Air 490 groundsheet	938271	59,95
Tavira Air 590 groundsheet	938281	69,95



Very spacious

You can find replacement hoses on www.reimo.com



Model	app.	app.	Item no.	Price
Tavira Air 390 Front with 3 windows	26 kg	80 x 50 x 40 cm	93826	999,-
Tavira Air 490 Front with 3 windows	27 kg	80 x 50 x 45 cm	93827	1149,-
Tavira Air 590 Front with 4 windows	28 kg	80 x 50 x 50 cm	93828	1399,-

Attachment to the vehicle:

- Piping Ø 7 mm

- 300D Oxford Ripstop Polyester
- UV protection
- Flame retardant
- 1 x Airtube
- Seams sealed

Tavira Air 390/490

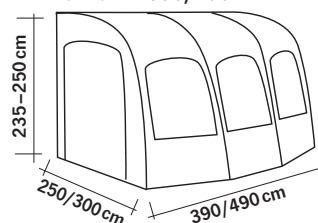

Tavira Air 590

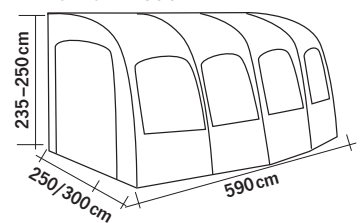

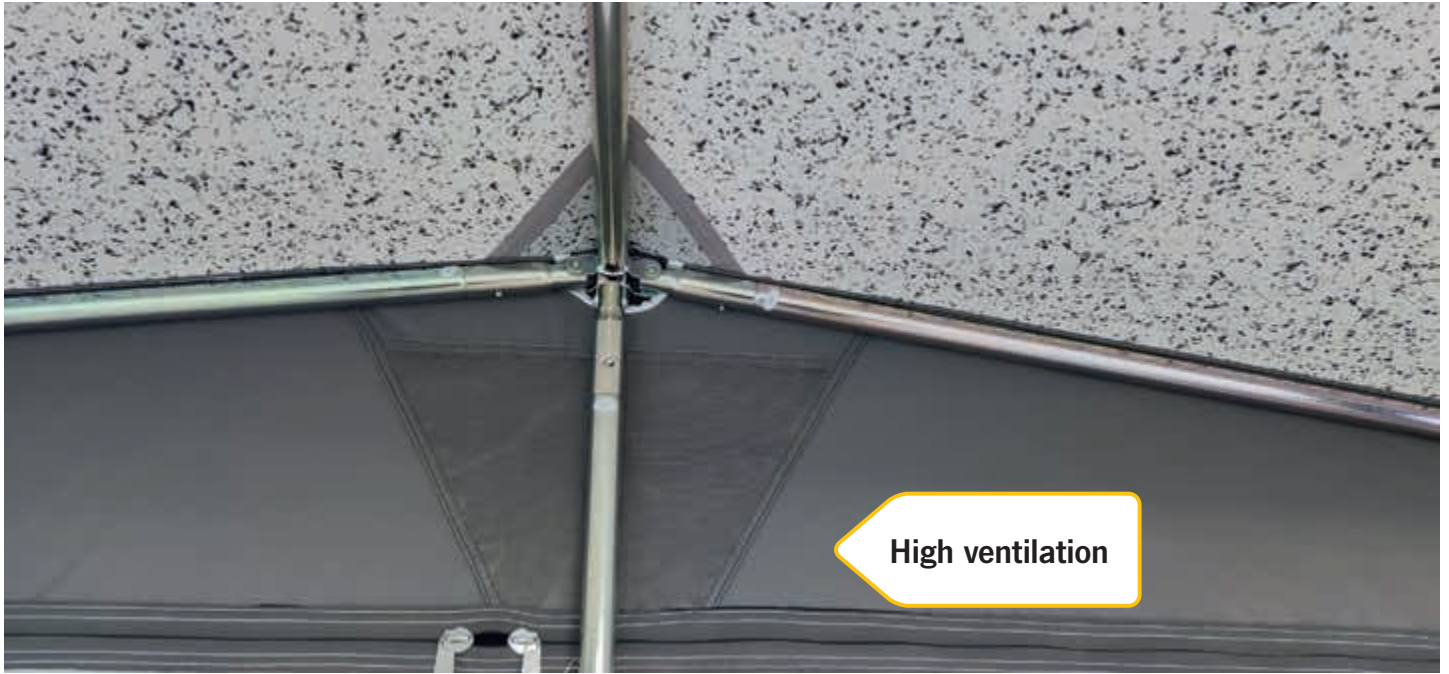



BOLOGNA 400

NEW
2024



Optional accessories:
Awning accessories and storm protection can be found from page 63 onwards
Awning carpets from page 66 onwards

Mounting height: 235 - 250 cm

BOLOGNA 400 – caravan awning

- Suitable as a year-round tent
- Canopy (30cm)
- Weather resistant
- Sturdy steel frame with quick-release device
- Front window with veranda function
- Large transparent windows with curtains and external cover
- Side panels with window + door
- Front & side windows can be rolled away sideways
- All windows with curtains for a cozy ambience and privacy
- Mosquito net insert in side windows
- Roof interior with design for a more comfortable atmosphere
- High ventilation under canopy
- High-quality YKK zippers
- 3 roof poles and 3 vertical supports
- Tensioning options under the windows and on the roof

Material:

Roof: coated polyester fabric (280g/m²)
 Walls: coated polyester fabric (230g/m²)
 Dirt strips: PVC (1-ply)
 Frame: tubular steel Ø22/25 mm
 Color: Light grey/grey/antracite
 Dims.: W 400 x D 240cm x H 235-250cm
 Weight: 34 kg

Scope of delivery:

Tent skin, poles (steel), veranda pole, wind screen, curtains, storm guy ropes, guy ladders, pegs and packing bag

936373

899,--



Veranda function

Caravan tent with circulation dimension



How do I measure the circumference

If you do not know the overall dims. of your caravan, you have 3 options for determining them:

- Look in the brochure or in the technical data supplied w/ your caravan
- Contact your caravan manufacturer and enquire about your overall dimensions, stating model and YOC.
- Measure yourself - the safest method. Caravan should be positioned horizontally on a level surface in order to measure overall dimensions of your caravan. You measure from guy point A (floor) through the keder strip of the caravan with a non-stretchable cord to guy point B (floor). If the keder rail still has an inward curve at the lower end, you must measure perpendicular to the floor or remove the cord from the rail at the insertion point.

Important for aerodynamic caravans:

For caravans with an extremely sloping front end, you must measure perpendicular to the ground from a height of approx. 185 cm (i.e. you no longer follow the rail).

This determined value is circulation dimension. Points A and B are also the guy points of your awning.

If the overall dimensions of your caravan are on the edge of the awning size specifications, you should opt for the smaller tent size. The size of your caravan awning depends solely on the overall dimensions. Only the depth of the tent is a free choice.

Attaching the roof poles to the caravan.

- With wall eyelets, firmly screwed (seal drill holes well)! We recommend this option for partial tents. The rear roof corners are fixed and do not move even in strong crosswinds. Wall eyelets are also a good choice for permanent camping.
- With screwless Vario clips! These are pushed onto the inner piping. The advantage of this variant is the flexibility in the choice of fixing points. Clip is connected to tent roof and cannot fall down if the pressure on the poles decreases.

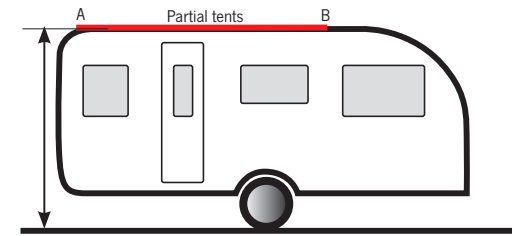
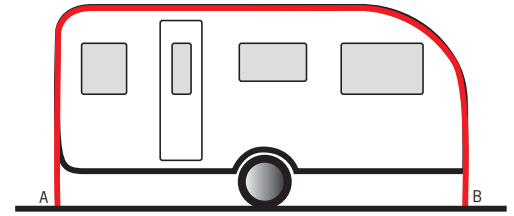

Photo shows size 12





PALERMO

Classic Palermo caravan awning
full caravan awning with 300 cm depth

- Suitable as a year-round tent
- Depth 300cm for generous interior space
- Canopy (30cm)
- Weather resistant
- Lightweight aluminum poles with quick-release device
- Front window with veranda function
- Large transparent windows with curtains and external cover
- Both front wall halves can be removed independently of each other
- Side panels with window + door
- Side windows can be rolled away to the side
- All windows with curtains for a cozy ambience and privacy
- Mosquito net insert in side windows
- Roof interior with design for a more comfortable atmosphere
- High ventilation under canopy
- High-quality YKK zippers
- Tensioning options under the windows and on the roof

Material:

Roof: Coated polyester fabric (280g/m²)
 Walls: Coated polyester fabric (230g/m²)
 Dirt strips: PVC (1-ply)
 Frame: aluminum tube Ø25/28mm
 Color: Light grey/grey/anthracite

Scope of delivery: Tent skin, poles (aluminum), veranda pole, wind screen, curtains, storm guy ropes, guy ladders, pegs, 2 packing bags

Circumferential dimension	Size	app. 	Linkage	itemNo.	Price
850-875 cm	9	32,5 kg	3 roof poles, 3 vertical supports	9363841	999,--
876-900 cm	10	33,0 kg	3 roof poles, 3 vertical supports	9363842	1099,--
901-925 cm	11	38,0 kg	5 roof poles, 3 vertical supports	9363843	1199,--
926-950 cm	12	39,5 kg	5 roof poles, 3 vertical supports	9363844	1249,--
951-975 cm	13	40,5 kg	5 roof poles, 3 vertical supports	9363845	1299,--
976-1000 cm	14	42,5 kg	5 roof poles, 5 vertical supports	9363846	1349,--
1001-1025 cm	15	43,5 kg	5 roof poles, 5 vertical supports	9363847	1399,--
1026-1050 cm	16	44,0 kg	5 roof poles, 5 vertical supports	9363848	1449,--





CORTINA 3

Very robust partial winter tent - tested in Lapland!



Ventilation closed

699,-

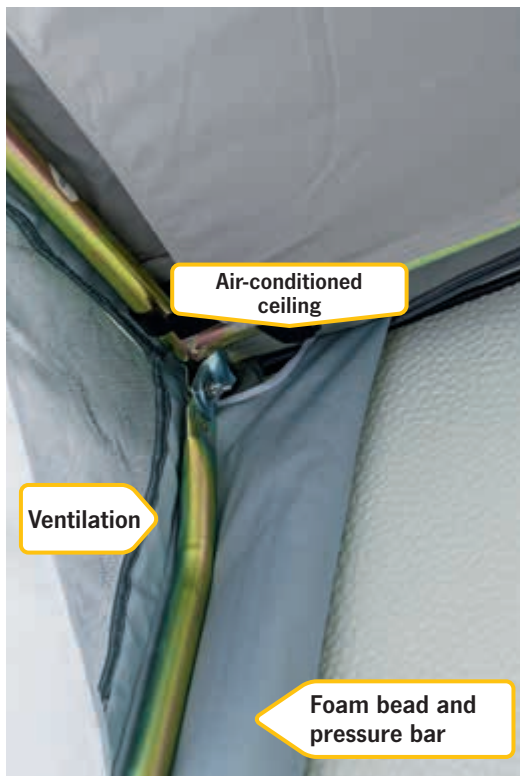

Air-conditioned ceiling

Ventilation

Foam bead and pressure bar



Double four strip



Roof overhang

Quick Lock Padset

Mounting height: 235 - 255 cm



Cortina 3 winter awning for caravans

- Very robust, well insulated, breathable
- Harnesses with quick release
- Good insulation due to climate-controlled canopy
- 2 separate doors in the side walls
- Breathable side walls
- Winterproof roof
- The right choice for every season

The CORTINA 3 all-season awning is suitable for summer and winter. The walls are breathable, the stable roof is winter-proof and the steel frame is robust. The awning is equipped with a large window in the front and windows in the side walls. Included are curtains in white for all windows and an attachable climate canopy in gray for a homely ambience and good insulation. The front wall can be opened in all directions with the 4-way zipper, can be completely removed or used as a veranda function. Pressure bars and sewn-on foam beads ensure a draught-free seal to the caravan and are completed by the wind skirt.

Scope of delivery: Tent skin, steel poles w/ Quick Lock Padset, climate canopy, curtains, wind protection, wheel protection, storm bracing, ropes, pegs.

	936980	699,-
Optionales Zubehör:		
Floor tiles 60 x 60 cm (4 pcs.)	90445	20,90
Villa Eco tent carpet (300 x 250 cm)	90402	45,95
Cortina 3 winter set for better support under snow load. 1 hurricane support & 4 adjustable ridge poles.		
	93635	99,95
Steel pegs (5 pcs.)	90275	11,50
Spare parts:		
Air-conditioned ceiling	936981	49,95
Curtains	936983	39,95
Steel rod	936982	249,-

Attachment to the vehicle: • Piping Ø 7 mm	Walls 100% acrylic	Steel Ø25/22 mm	app. 102 x 37 32 cm
	Roof 100% PVC	Flame retardant	app. 30,5 kg

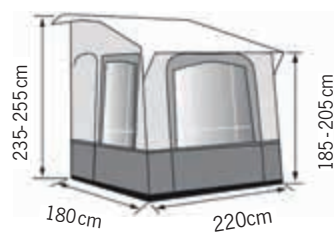



CASA ROYAL 2



Mounting height:
235 - 255 cm



Casa Royal 2 - in 2 sizes

- Winterproof roof
- Sturdy steel frame
- Booms with hurricane supports as standard
- 2 doors in the breathable side walls
- Thick, winter-proof roof

The side walls made of spun-dyed isoacrylic offer a pleasant living climate like cotton. Front wall with 4-way zipper can be opened from both sides and is removable. Front window made of foil with curtains. Top side window w/ mosquito net & foil cover on outside, bottom window in foil w/ curtains. Frame w/ additional hurricane supports next to doors, veranda pole & ridge reinforcement as standard.

Ventilation: Lockable bottom vent on both sides and forced ventilation in the top corner. Sealing to the caravan with foam bead and bent pressure rods.

Scope of delivery: Tent skin, steel poles with Quick Lock Padset, climate canopy, curtains, wind protection, wheel protection, storm bracing, ropes, pegs.



Model	app.	app.	Item no.	Price	Spare parts					
					Air-conditioned ceiling	Curtain set	Steel rod			
Casa Royal 2, 320 cm	47,5 kg	110 x 42 x 38 cm	936392	999,-	936393	69,95	936394	66,95	936391	379,-
Casa Royal 2, 390 cm	57 kg	110 x 42 x 43 cm	936382	999,-	936383	49,95	936384	65,95	936381	399,-

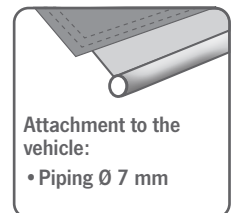

Optional accessories (for Casa Royal 2 320 & 390):

Casa Royal steel winter set

1 hurricane support, 4 adjustable ridge poles 6.2 kg **936351 99,95**

Steel herringbone (5 pcs.) 90275 11,50

Floor tiles 60 x 60 cm (4 pcs.) 90445 20,90

Villa Eco tent carpet (350 x 250 cm) 904020 52,95 (for 936392)

Villa Eco tent carpet (400 x 250 cm) 904021 62,95 (for 936382)

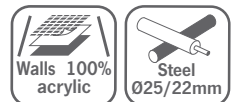
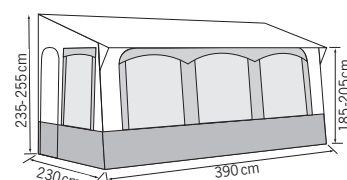
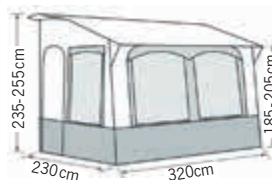



4 spacers per set

- Ideal for use with caravan canopy/protective cover
- Protects your caravan from damage
- Especially light

Protect the outer wall of your caravan from chafing when using a caravan canopy / protective cover by using spacers and the corner protector. Sets consist of 4 parts & are particularly light-weight being made of EPP (polypropylene)

① **Spacer:** dims. 12 x 12 x 7.5 cm, weight: 0.1 kg
4 piece **928643** **14,95**

② **Corner protector:** Dimensions 27.5 x 17.5 x 7.5 cm, weight: 0.15 kg
4 piece **928644** **24,95**

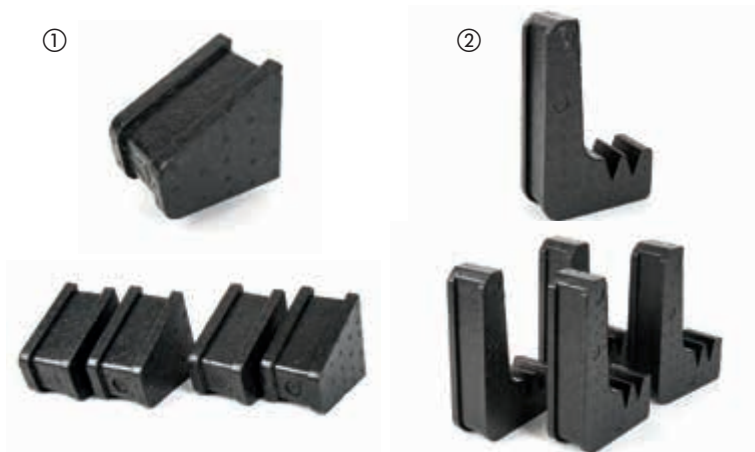

Pull-on aid for caravan & motorhome covers

Practical help to get protective roofs or protective covers over the caravan
Telescopic 71 - 120 cm, material: aluminum, with hook.

903075 **9,95**



Caravan canopy - for caravan up to 230 cm width

- Reliable weather protection
- Caravan tarpaulin winterproof and breathable
- Partial cover for better ventilation: reduction of mold risk
- Made of high-strength 3-ply SFS fabric 160 g/m²
- Waterproof and UV resistant

Caravans are exposed to the weather - especially when vehicles are parked outdoors. Precipitation and intense sunlight, but also dust, dirt, bird droppings or tree resin leave their mark over time and affect not only the appearance of the vehicles, but also their service life.

A caravan cover is inexpensive to purchase and offers reliable protection. As a result, the paint of your vehicle remains maintained and does not weather - and your upholstery fabrics in the interior are also protected from fading by the caravan cover. Color: Grey



from **119,-**



505 x 300 cm	92862	119,-	655 x 300 cm	928622	149,-
555 x 300 cm	92863	129,-	705 x 300 cm	928623	169,-
605 x 300 cm	92864	139,-	755 x 300 cm	928624	189,-



Belt size: Important for determining size, pls. take bike racks & overhangs into account.



62,95

Floor skirt

Tarpaulin made of 210T polyester, PVC coated. With two large zippered pockets and two small pockets. Including pack sack. Weight 3.3 kg. Dims.: W 600 x H 45 + 15 cm

Light gray **90599** **62,95**



139,-

2-piece thermal mat for Adria caravans

- Heat and cold protection on request
- Attachment with suction cups and Velcro tape
- Suitable for Adria caravans of Alpina & Adora series w/ large panoramic window in the front

37324 **139,-**



Caravan protective cover

Premium caravan protective cover

- Reliable, water repellent weather protection
- Roof made of Tyvek-like breathable material in white for optimum UV protection
- Both sides can be opened with a zipper
- Good ventilation, reduction of mold risk
- Made of tear-resistant and durable 3-ply SFS fabric: roof 125 g/m², Sides 100 g/m²

Breathable and weatherproof protective cover, preserves the value of your caravan. Both side walls are easy to open with a zipper and allow access to the caravan.

Up to 230 cm caravan width, height 220 cm			
Length top / bottom			
445 / 520	928541	239,-	
505 / 580	928542	249,-	
565 / 640	928543	259,-	

Up to 250 cm caravan width, height 220 cm			
Length top / bottom			
475 / 550	928544	239,-	
515 / 590	928545	249,-	
555 / 630	928546	259,-	
595 / 670	928547	269,-	

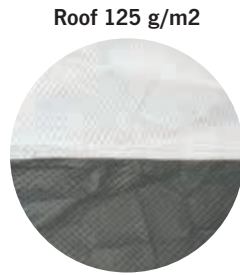
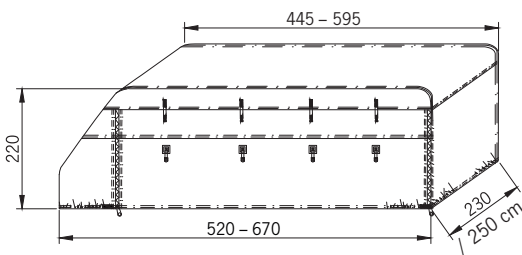

Pages 100 g/m²



Both side walls can be opened



Up to 230 cm or 250 cm wide

Suitable for caravans with a length of 520 to 670 cm

Caravan protective cover - for caravan up to 230 or 250 cm width

- Reliable weather protection
- Flexible opening with zipper on all 4 corners
- Protective hood winterproof & breathable at same time
- Good ventilation, reduction of mold risk
- Made of high-strength 3-layer SFS fabric: 160 g/m²
- Waterproof and UV resistant

With this breathable protective cover you protect your caravan from UV radiation, mold, water, dirt, dust, and other weather influences. Access is possible at any time thanks to the roll-up side walls.

For caravans up to 230 cm wide, height 220 cm			
bottom	top		
520 cm	446 cm	928628	169,-
580 cm	506 cm	928629	189,-
640 cm	566 cm	928630	209,-
700 cm	626 cm	928631	229,-
760 cm	686 cm	928632	249,-

For caravans up to 250 cm wide, height 220 cm			
bottom	top		
510 cm	436 cm	928633	199,-
550 cm	476 cm	928634	209,-
590 cm	516 cm	928635	219,-
630 cm	556 cm	928636	239,-
670 cm	596 cm	928637	259,-
710 cm	636 cm	928638	269,-

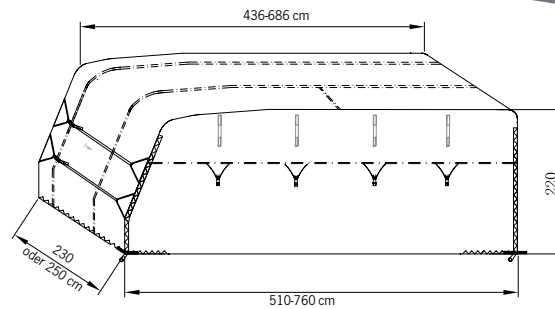

Protective covers for motor-homes on page 65





Tents for motorhomes & camper vans



Shine - Sunsail in 4 widths, with piping Ø5/8mm for awnings and Multirail

- UV-resistant
- Reflective
- Depth 190 cm
- Easy installation thanks to double piping Ø 5/8mm

The sunsail made of UV-resistant, reflective material has a double piping with Ø 5+8 cm, so that it can be used for standard awnings, but also for camper vans with Multirail.

Delivery includes tensioning material in a practical carrying bag.

(Support poles must be ordered separately!)

Material: 185g/m² PE (polyethylene)

Depth 190 cm, Color: Silver-grey

i This sail does not protect from rain



Versions	 app.	Ar-No.	Price
Width: 240 cm	1,5 kg	906883	39,95
Width: 290 cm	1,8 kg	906884	44,95
Width: 340cm	2,0 kg	906885	49,95
Width: 390 cm	2,2 kg	906886	54,95

Recommended Support poles:

196 cm, 2 pieces

903076

14,95



Mauritius - Canopy & sunsails for small and large vehicles

- **Sunsail with high variability, shade for large and small vehicles**
- **Vehicle connection: loops for fastening with suction cups (see page 101) and 5 + 8 mm piping profile**
- **Eyelets at all corners**

The hinged side panels can be tensioned downwards for additional protection. Colour light grey.
 Scope of delivery: Awning, adjustable steel poles max. H 220 cm (2 pcs. for Mauritius M+L, 3 pcs. Mauritius XXL), 6 pegs, 6 guy ropes, stuff sack.



Mauritius M (Dimensions sketch ①)
 Keder length 200 cm, dims.: W 460 x D 300 cm,
 pack size app. 66 x Ø 12 cm, weight: 4.6 kg
900575 131,-

Mauritius L (Dimensions sketch ②)
 Keder length 250 cm, dims.: W 510 x D 300 cm,
 pack size app. 66 x Ø 13 cm, weight: 5.0 kg
900573 152,-

Mauritius XXL (Dims. sketch ③)
 Keder length 300 cm, dims.: W 560 x D 300 cm,
 pack size app. 66 x Ø 16 cm, weight: 6.6 kg
900572 179,-

The tried and tested Mauritius awning is available in the existing 3 sizes in the **RE-TENT** collection

RE-TENT the new collection from **Reimo TentTechnology** to protect our nature.



The tent fabrics are made from recycled disposable plastic bottles. Each m² corresponds app. to 3 x 5 l Coke plastic bottles or 9 x 550 ml water plastic bottles.

Mauritius 460, 510 & 560 RE-TENT sunsail

Made from recycled disposable plastic bottles

- **Eyelets in all corners**
- **Variable tensioning**
- **For small and large vehicles**
- **Polyester fabric: Global Recycled Standard**

Material: 300D recycled Oxford polyester
 Vehicle connection: piping Ø5+8mm + loops, color: grey
 Scope of delivery: awning, 2 poles, guy ropes, stuff sack. See below for dimensions, pack size & weight.



Mauritius 460 (dimensions sketch ①)
900576 149,-

Mauritius 510 (Dimensions sketch ②)
900577 174,-

Mauritius 560 (Dimensions sketch ③)
900578 199,-

Dimensions all Mauritius models:

Sketch ①

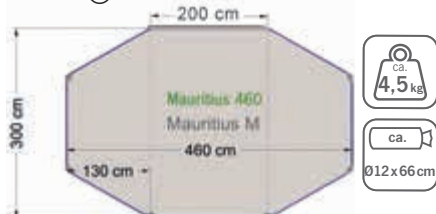

Sketch ②

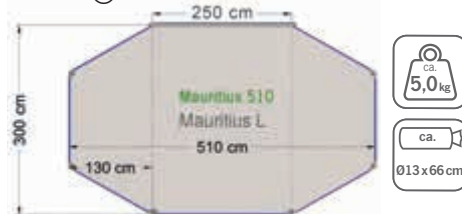

Sketch ③

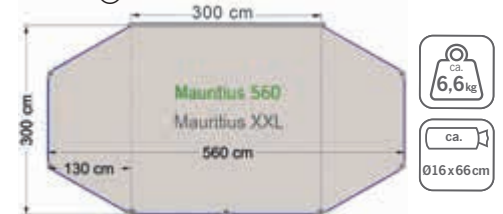



from **84,95**

Charly & Charlyne - Inexpensive Sun canopies for mini campers and small buses

- Inexpensive sun canopy
- Vehicle connection with 5+8 mm piping profile or lock bar
- Waterproof and tear-resistant

Plain and simple - the cost-effective solution for the small shade.

Scope of delivery: Sun canopy, sluice pole, 2 steel poles, guy ropes, pegs and packing bag

Model	Charlyne 1.8 for minicamper (kR)	Charlyne 2.2 for minicamper (IR)	Charly for Camping buses
Suitable for the following vehicles	VW Caddy, Citroën Berlingo, Peugeot Partner, Opel Combo, Renault Kangoo, FIAT Doblo, Mercedes Citan, Ford Connect	VW Caddy Maxi, Opel Combo, Renault Kangoo, FIAT Doblo, Mercedes Citan, Ford Connect.	small buses such as VW T5/T6, Citroën Spacetourer, Renault Trafic, etc.
Dims.	W 180 x D 240	W 220 x D 240	W 255 x D 240
app. weight	3,8 kg	3,9 kg	4 kg
Item number	90066	90068	90049
Price	84,95	89,95	99,95



Multirail awning bracket

for attaching awnings and bus awnings. Combined rain gutters, awning brackets and roof rack attachments.

More informations at reimo.com



from **79,90**



Como - The universal Canopy

- Extremely tear-resistant
- Weatherproof and washable
- With 5+8 mm piping connection

Material: Sunsail sizes 1, 2 and 3 made of Oxford polyester 210 D, from size 4 300 D Oxford polyester **Colors:** Light gray or anthracite. **Scope of delivery:** Sunsail Size 1 and 2 with two poles, from size 3 with three poles, pegs and guy ropes

Light gray, depth: 240 cm

Versions	app.	Art.No.	Price
Size. 1 200 cm	2,5 kg	90020	79,90
Size. 2 250 cm	3,0 kg	90021	89,90
Size. 3 300 cm	3,5 kg	90022	99,90
Size. 4 350 cm	4,0 kg	90023	109,90
Size. 5 400 cm	4,5 kg	90024	129,-
Size. 6 450 cm	5,0 kg	90025	139,-
Size. 7 500 cm	5,5 kg	90026	159,-
Size. 8 700cm	7,5 kg	90019	159,-
Size. 10 900 cm	8,5 kg	90017	189,-

Anthracite, depth: 240 cm

Versions	app.	Art. No.	Price
Size. 2 250 cm	3,0 kg	900212	89,90



Size 8



Size 4 Anthracite



Sun canopies for mini campers and small buses

PALM BEACH sun canopy

- Dome roof against water pockets
- Roof with 2 diagonal fiberglass poles
- Generous sense of space
- Double piping Ø5+7 mm and tunnel

Palm Beach Quick sun canopy

- With quick assembly system
- Can be opened with 1 handle
- Fixed fiberglass rods
- Color: light grey/anthracite

Palm Beach Quick 2.6

- Suitable for camper vans with short wheelbase

Scope of delivery: Sun canopy incl. 2 fiberglass poles, 2 poles, pegs and guy ropes, packing bag
W 260 x D 240 cm, pack size Ø11 cm x 186 cm, weight: app. 5.5 kg **900159 169,95**

Palm Beach Quick 3.0

- Suitable for camper vans with long wheelbase

Scope of delivery: Sun canopy incl. 2 fiberglass poles, 3 poles, pegs and guy ropes, packing bag
W 300 x D 240 cm, pack size Ø11cm x 202cm, Weight: app. 6.8 kg **900169 189,95**

Palm Beach 2 sun canopy

- Small pack size
- Pockets with Velcro in the corners for easy insertion of the fiberglass rods
- Color: Light grey/anthracite/lime

Palm Beach 2 - 2.6

- Suitable for camper vans with short wheelbase

Scope of delivery: sun canopy, 2 fiberglass poles, 2 poles, pegs and guy ropes, packing bag
W 260 x D 240 cm, pack size Ø16 cm x 74 cm, weight: app. 5.5 kg **900151 149,-**

Palm Beach 2 - 3.0

- Suitable for camper vans with long wheelbase

Scope of delivery: sun canopy, 2 fiberglass poles, 3 poles, pegs and guy ropes, packing bag
W 300 x D 240 cm, pack size Ø18 cm x 74 cm, weight: app. 6.8 kg **900152 169,-**

Palm Beach side walls

- Suitable for all Palm Beach sun canopies
- Window with mosquito net and cover inside
- Simple attachment to the roof with Velcro
- Mountable on both sides

① Palm Beach side panel

- Narrow width for unhindered opening of sliding door

W 225 x H 180 cm, weight: app. 2.2 kg **900153 99,-**

② Palm Beach Space side panel

Height of 200cm allows further extension for more space under the sun canopy

W 240 x H 200 cm, weight: app. 2.5 kg **900154 109,-**

Replacement fiberglass rods (2 pieces) for:

Palm Beach 2 - 2.6 (900151) **900148 19,95**

Palm Beach 2 - 3.0 (900152) **9001481 19,95**



Photo shows Palm Beach Quick



Photo shows Palm Beach



You can find matching awning carpets from page 66 onwards



HISPANIOLA

269,-



Mosquito net doors included in the scope of delivery

Mounting height: 185 - 220 cm



Hispaniola sunsail

- Practical awning, which can also be used as an awning
- Removable front and side panels
- The separate mosquito nets can be used instead of the walls
- Structure with only one fiberglass rod

Multifunctional sunsail/awning for camper vans with a piping rail length from 2.60 cm. The front and side panels can be completely removed and easily stowed away in the pockets sewn inside. The large windows are fitted with tinted film.

Scope of delivery: sunsail with walls & mosquito nets, fiberglass pole, clamping pole with clamps, guy ropes, pegs, packing bag.

90687

269,-



Removable doors and front



Storage nets

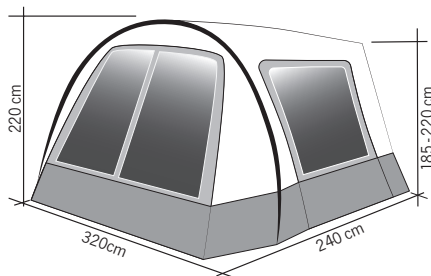

Attachment to the vehicle:

- Double piping Ø 5+8 mm
- Locking bar
- Anchor loops

UV protection 50+

3.000 mm

Fiberglass

190HD polyester

app. 10 kg

app. 75 x 21 x 19 cm



Magnet adapter set (3 pieces)

For quick and easy attachment of the awning to the vehicle without Multirail. The magnetic tape can be used to securely attach your awning to the car. Scope of delivery: Magnetic tape with piping profile (length 283 cm), 3 x double piping rails each 90 cm, piping tube.

1 set

904490

43,95



ANTIGUA AIR

Mounting height:
180 - 220 cm



Sunsail Antigua Air

- Practical sunsail, can also be used as an awning
- Quick set-up with just one air hose
- Large windows with interior cover
- Including side panels for hanging (hooks) and front (zipper)

For camper vans with a mounting height of 180 to 220 cm. The sunsail becomes an awning with 2 side walls that can be hooked in & a front wall that can be zipped in.

All walls with large transparent windows and inner cover.

Scope of delivery: Sunsail with air tube, 2x side/ 1x front wall, 2x steel roof poles, guy ropes, pegs, packing bag and air pump.

90688

399,-

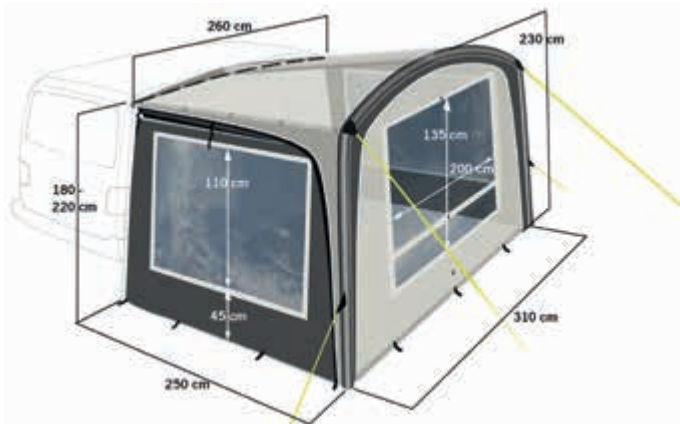

Attachment to the vehicle:

- Double piping Ø 5+8 mm
- Locking bar
- Anchor loops

190T polyester

3.000 mm

Seams sealed

Airtube

UV protection

Flame retardant

app. 13 kg

app. 70 x 30 28 cm



Sun canopy for camper vans



Mauritius Premium awning – Canopy & sun canopy for small and large vehicles

- Sun canopy with sewn-on side panels that can be tensioned or rolled up as required
- Dome roof has 2 fiberglass diagonal rods to prevent water pockets
- High-quality premium material
- Available in 2 designs: light grey/anthracite or completely anthracite

Stylish and robust sun canopy made of heavy, premium quality. Domed roof with 2 diagonal rods (fiberglass) scores with a comfortable standing height & prevents water pockets from forming in rain. The sewn-on side panels can be tensioned or rolled up as desired.

Scope of delivery: Sun canopy, 2 set-up poles, 2 fiberglass diagonal poles, lock pole, pegs, guy ropes.



Light gray version with rolled-up side panels



Light gray version with diagonally braced side panels

Versions	Color		Item no.	Price
Width: 260 cm	Light gray	9 kg	900155	249,-
Width: 300 cm	Light gray	10 kg	900156	279,-
Width: 260 cm	Anthracite	9kg	900157	249,-
Width: 300 cm	Anthracite	10 kg	900158	279,-

Attachment to the vehicle:

- Double piping Ø 5+7 mm
- Locking bar
- Anchor loops

300D Oxford Polyester

UV protection 50+

2.000 mm

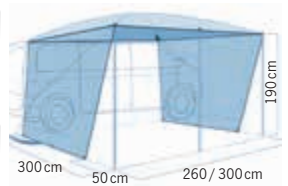

Flame retardant

Fiber/Steel

app. 90 x Ø 20 cm

Playa Van awning

- Universal awning for buses
- With large side windows
- Structure with only one fiberglass rod
- Vehicle connection with Ø 5+8 mm piping profile, lock bar tunnel and loops

Dimensions: W 260 x D 220 x H 180-200 cm

Scope of delivery: Awning, steel and fiberglass poles, ground pegs, guy ropes

906880 159,-



Piping Ø 5+8 mm

185T, 68D polyester

UV protection 50+

1.000 mm

Flame retardant

Fiber/Steel

app. 5,5 kg

app. 77 x Ø 17 cm



Privacy screen/Partition curtain for the tailgate/rear door



49,95



Privacy screen, shower/shower Partition curtain, awning for Fiat Ducato & large vans with hinged doors

- Easy attachment via Velcro

The curtain can be used as a privacy screen or shower/partition curtain. The attachment is made by Velcro directly to the vehicle. The curtain can also be used as a sun awning. Delivery incl. tensioning material. Set-up rod not included in scope of delivery.

Dims.: app. L 200 x W 165

936291 49,95

 190T polyester	 2.000 mm	 UV protection coated
 Flame retardant	 app. 1,5 kg	 app. Ø 25 x 75 cm

RECOMMENDED ACCESSORIES:

Support bar
903070 28,95

Further support poles on page 62



2 in 1 privacy screen and Shower curtain for the van tailgate opening

- Privacy screen, blackout and curtain in one
- Shower without getting wet in the rear
- Simple fixation
- Suitable for almost all Volkswagen T5 / T6 panel vans, all models
- Mercedes Vito, V-Class, Marco Polo, Metris, all 3 lengths, from 2014
- Renault Trafic, Opel Vivaro B, Nissan NV 300, from 2001, Fiat Talento from 2016, KR + LR
- Citroën Spacetourer / Jumpy, Peugeot Traveller / Expert, Toyota Pro Ace Verso from 2016, Opel Zafira Life / Vivaro C from 2019, all 3 lengths
- Ford Transit Custom H1 and Nugget



The privacy screen can be used with or without a rear tent (no tight seal). Simply attach over the tailgate with the adjustable strap and fix to the bumper with plastic hooks if needed. Water column 2,000 mm, dimensions: app. 153 x 186 cm, weight approx. 0.5 kg.

Color grey **936287 34,95**



34,95



Trapeze - rear tent

for Volkswagen Caddy (<2020), Kangoo (type W from 2008), Doblo, Partner, Berlingo (from 2008, type B9), Citan

- No bars required
- Low weight
- Space for a camp bed

No poles, small pack size & easy pitching make the Trapeze rear tent the perfect choice. The PVC window in the roof provides more light. (support poles not included in the scope of delivery)

Scope of delivery: Tent, pegs and rucksack
93791 129,90

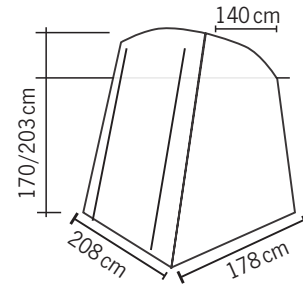

129,90

Support poles
on page 62

FIT:



Telescopic uprights with clamping screw,
 steel Ø 22 mm, 3-part, app. 165 - 250 cm,
 Aluminium Ø 25 mm, 3-part, approx. 170 - 260 cm,

90307 33,30
903070 28,95

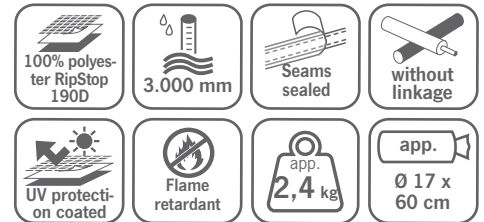

from **117,90**

Vertic - rear tent

- No linkage required
- Low weight and quick assembly
- Plenty of storage space

No poles, small pack size and easy pitching make the Vertic rear tent the perfect choice. Rear wall can be raised as an awning. The PVC window in the roof provides more light.

Scope of delivery: tent, pegs, Velcro tape & packing bag (pitching poles not included)

For VW Caddy KR and LR and others
93792 117,90

For Kangoo II (type W from 2008), Mercedes Citan (from 10/2012), Citroën Berlingo II (type B9), Peugeot Partner Tepee (from 05/2008), Fiat Doblo II (type 263, from 2010), Opel Combo ("D" from 10/2011)

Description as above, **Dims.:** B130 x H195 x D132 cm
93795 119,90

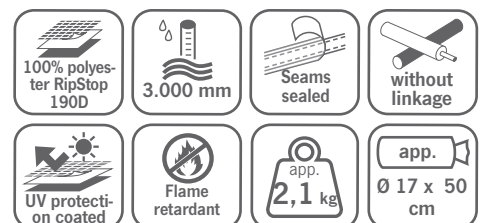
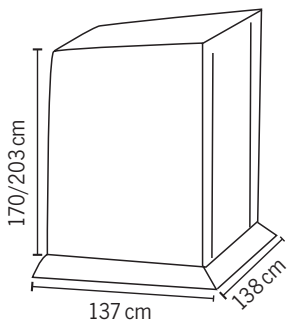



Rear tents for Volkswagen Caddy & Minicamper

VW Caddy 5 Premium - rear tent (for VW Caddy 5 from 2021)

also suitable for Ford Connect 3

- Without bars
- Mosquito net in both sides and front wall
- Front door can be used as an awning
- Incl. removable base

The rear tent is simply pulled over the tailgate and secured with sewn-on straps and plastic hooks. The front wall is equipped with a large zippered door (with additional mosquito net), which can also be used as an awning. Side walls each have a zippered door with an additional mosquito net layer and the roof has a PVC window above the rear window. The groundsheet is attached with Velcro and can be removed at any time.

Floor plan dimensions: 240 x 190 cm

Scope of delivery: Tent skin, 2 pitching poles, groundsheet, pegs, guy ropes, stuff sack

937911 249,-



 100% polyester RipStop 190T	 3.000 mm	 Seams sealed	 without linkage
 UV protection coated	 Flame retardant	 app. 4,5 kg	 app. Ø 22 x 60 cm



Rear sunroof

for VW T5 / T6 / T6.1 with gullwing doors

- Robust weather protection
- Protection from sun, rain and draughts
- Quick and easy to install
- No bracing required on the ground

Rear tent is simply stretched over open rear doors and serves both as sun & rain protection & as protection against draughts when doors are open. A telescopic tension rod between doors defines distance and holds tarpaulin in place. It is connected to the vehicle by means of an adjustable elastic strap and plastic hooks, and secured with magnets. Quick and easy installation without modifications to the vehicle

Dims.: app. width 160 x depth 80 cm

Scope of delivery: Sun canopy, 1 tension rod (aluminum), pannier bag

937983 119,-



 app. 1,5 kg	 3.000 mm	 Flame retardant	 UV protection coated
-----------------	--------------	---------------------	--------------------------

300D Oxford Polyester



Rear tents for Volkswagen Transporter 5/6/6.1



Instant - Quick set-up tent for VW Transporter 5/6/6.1 without poles

- No bars required
- Low weight - only 2.4 kg
- Simple structure
- Changing room at the bathing lake
- Shower tent at the rear
- For VW Transporter 5/6/6.1 with tailgate

No poles, small pack size and easy pitching make the Instant rear tent the perfect choice for all van drivers.

The rear tent is sewn to the rear bag and is attached to the tailgate with press studs (still need to be attached). This means the tent can simply be stowed away in the tailgate

93790

149,90

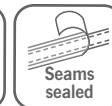
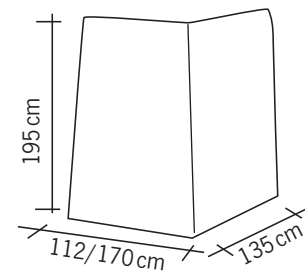

Floor for rear tents

- Rear tent floor with integrated windbreak
- Easy to attach to the rear tent using Velcro fasteners on the tent wall

Material: PE

Scope of delivery: Rear tent floor with 6 eyelets, including pegs, 3 plastic hooks & Velcro tape for attachment to rear tent & vehicle.

For the Trapez & Vertic rear tents, for Trafic & Hiace:

Dimensions: 250 x 220 cm

936288

29,90

For the rear tents Upgrade, Update:

Dimensions: 240 x 210 cm

936289

29,90





Tailgate tents for Volkswagen Transporter 5/6/6.1

Upgrade Dome Premium - rear tent

for Volkswagen Transporter 5 / 6 / 6.1 with barn door

- Domed roof with window for a generous feeling of space
- Considerable space expansion
- Doors can be closed when the tent is erected
- Trough-shaped floor tarpaulin protects against moisture and draughts
- Front with mosquito net
- Spacious and stable
- Australian standard

The highlight of the newly developed Upgrade Dome Premium rear tent: wing doors can be closed when tent is set up. Domed roof gives generous feeling of space & at the same time prevents water pockets when it rains. The U-shaped tubular steel frame promises stability. The front wall has a large door (can be used as an awning) and a transparent window with inner cover and additional mosquito net. The side walls with oval windows and the skylight window in the roof ensure good all-round visibility. A groundsheet with integrated wind protection under the bumper, which is secured with Velcro, completes the tent.

Dims.: W 250 cm x D 210 cm H 210 cm

Pack size: app. 95 cm x 20 cm x 22cm

Scope of delivery:

Tent, groundsheet, steel frame,
2 fiberglass poles, 2 steel pitching poles,
guy ropes, pegs, packing bag

936292

349,-

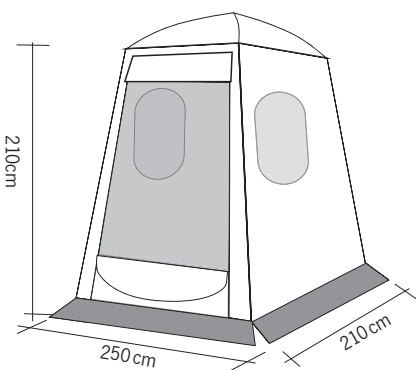

 Flame retardant	 UV protection coated	 100% polyester RipStop 190T
 app. 10,3 kg	 3.000 mm	

Rear tents for Fiat Ducato and Toyota Hiace



Harness for Toyota Hiace

- Rear tent without poles
- Both side panels and rear panel with door
- Tinted windows with interior cover
- Mosquito net window
- With window in the roof as skylight

With particularly large interior space for camp beds, bicycles, etc. Simply pull rear tent over the open tailgate and secure it to the ground. The back wall with mosquito net window can also be used as a sun awning.

With Velcro tape on the side walls to attach the optional tent floor

Scope of delivery:

Tent skin, including storage bag

937961 199,-

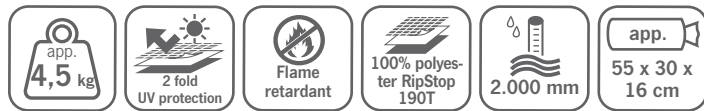
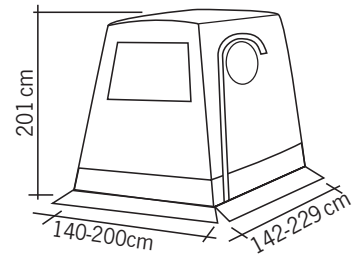

Rear awning TRAPEZE only suitable for Asia type Toyota Hiace H200 (not available in Europe), not suitable for Europe Hiace type XH10

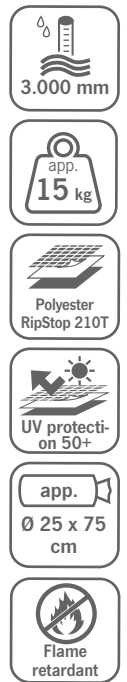

Rear tent Ducatissimo Premium for Fiat Ducato (and identical vehicles) with wing doors

- Premium equipment
- For hinged doors
- Removable groundsheet
- Mosquito net in door
- Door can be used as an awning

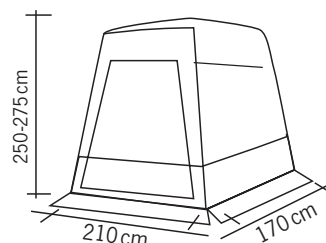

New Ducatissimo Premium rear tent for large vans was developed for Fiat Ducato & similar vehicles with gullwing doors developed. The front wall has a large zippered door with mosquito net & transparent PVC window with cover. This can be rolled up or used as a sun sail. U-shaped tubular frame Ø25/22 mm can be dismantled for a small pack size & is height-adjustable. The connection to the vehicle is made by an adjustable strap and loops. The strong PVC fabric provides a sturdy roof. The removable groundsheet with integrated windbreak under the bumper is attached to the tent and vehicle using Velcro.

937982 349,-



Rear tents for Volkswagen Transporter 5/6/6.1

Upgrade Premium - Rear tent with premium equipment for Volkswagen Transporter 5/6/6.1

- All 3 doors with mosquito net zipped doors
- Sewn-in bottom tray, closes with rear entrance
- PVC windows in the roof
- Space for a camp bed
- Meets Australian requirements

No poles, small pack size, light weight and easy set-up make the Upgrade Premium rear tent the perfect rear tent for van drivers. The new features such as mosquito nets in all zipper doors, bumper skirt and sewn-in floor pan offer additional comfort. The front door can be set up as an awning and the two side entrances have tinted windows.

Scope of delivery: Rear tent, guy ropes, pegs, 2 pitching poles and pack sack.

936286 249,-

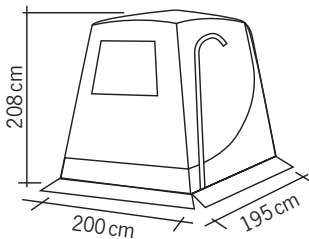

 100% polyester RipStop 190T	 3.000 mm	 Seams sealed	 without linkage
 UV protection on coated	 Flame retardant	 app. 4,5 kg	 app. Ø 22 x 60 cm



Ventilation above the entrance



Upgrade 2 - More living space for Volkswagen Transporter 5/6/6.1

- No linkage required
- Low weight
- PVC windows in the roof
- Space for a camp bed
- Changing room at the bathing lake
- Shower tent at the rear
- For VW Transporter 5/6/6.1 with tailgate

No poles, small pack size and simple set-up make the Upgrade 2 rear tent the perfect choice for all van drivers. Window and entrance in both side walls. Simply slip it over the tailgate and there is space for a camp bed, bicycle or simply to get more fresh air in the vehicle. Front can be raised as a sun awning. PVC window in the roof provides more light.

Scope of delivery: Tent, guy ropes, pegs, 2 pitching poles & stuff sack.

Color grey/anthracite/lime

936280 159,90

Matching groundsheet with integrated windbreak, description see page 32

936289 29,90



 100% polyester RipStop 190T	 3.000 mm	 Seams sealed	 without linkage
 UV protection on coated	 Flame retardant	 app. 4,4 kg	 app. 63 x 33 31 cm

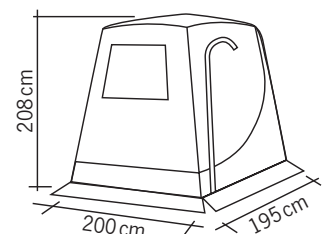

Rear tents for Renault Trafic and similar



249,-

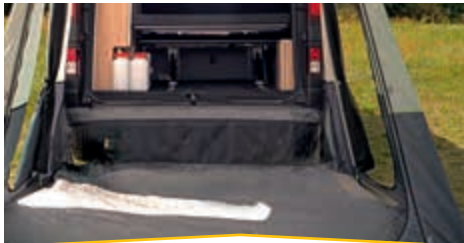

Sewn-in base tray

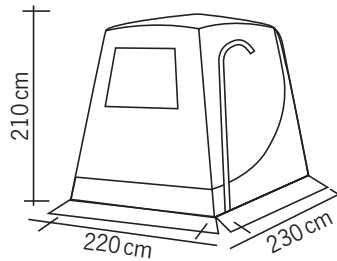

190T ripstop polyester	UV protection coated	3.000 mm	Flame retardant	without linkage	app. 4,5 kg	app. Ø 30 x 60 cm
------------------------	----------------------	----------	-----------------	-----------------	-------------	-------------------

Rear tent Trapez Premium for Renault Trafic

Also suitable for Citroën Spacetourer / Jumper, Campster, Peugeot Traveller / Expert, Toyota Proace (all from YOC. 2005), Ford Transit Custom, Fiat Talento, Nissan NV300, as well as Opel Vivaro / Vivaro C and Zafira Life - from fall 2019

No poles, small pack size, light weight and easy pitching make the "TRAPEZ PREMIUM" the perfect rear tent. The new features such as mosquito nets in all zipper doors, bumper skirt and sewn-in floor pan offer additional comfort. The front door has an additional mosquito net window and can also be set up as an awning. The two side entrances have tinted windows with covers. Bestseller with protection against mosquitoes & insects has additional ventilation above the entrance & can be attached to the side of the vehicle with clips. The sewn-in floor pan can be attached to the bumper with Velcro. The window in the roof can still be used as a skylight.

The large interior is suitable for a camp bed, bicycles, as a dog area etc. and can also be used as a changing room or shower tent.

The rear tent is simply pulled over the open tailgate and then attached to the vehicle and floor.

Scope of delivery: Rear tent, guy ropes, pegs, 2 pitching poles and packing bag

937962

249,-



199,-



Trapez Traffic - rear tent without poles

For Renault Trafic, Ford Transit Custom, Fiat Talento, Nissan NV 300 with tailgate, Citroën Spacetourer/Jumpy, Peugeot Traveller /Expert, Toyota ProAce Verso from 2016, Opel Vivaro/ Zafira Life/Vivaro C from 2019

- Both side panels and rear panel with door
- Window with inner cover
- Mosquito net window
- With window in the roof as skylight

With extra large interior, for camp bed, bicycles, or similar. Rear tent simply pull over open tailgate & attach to the ground. The back wall with mosquito net window can also be used as a sun awning.

Scope of delivery: Tent skin, including packing bag, pegs and guy ropes

93796

199,-

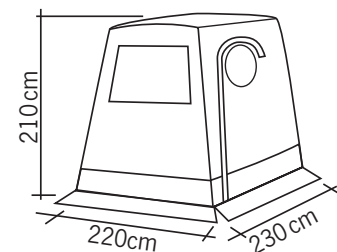

100% polyester RipStop 190T	UV protection coated	3.000 mm	Flame retardant	app. 3,5 kg	app. 55 x 30 x 16 cm
-----------------------------	----------------------	----------	-----------------	-------------	----------------------

Update Vito Premium - rear tent with premium equipment

for Mercedes Vito, Marco Polo and V-Class from YOC. 2015

- Sewn-in base tray
- Mosquito nets in all doors
- Skylight
- Space for 1 camp bed

No poles, small pack size, light weight and easy pitching make the Update Vito Premium the perfect rear tent. New equipment features such as mosquito nets in all zipper doors, bumper skirt & sewn-in floor pan offer additional comfort. The front door has an additional mosquito net window and can also be set up as an awning. The two side entrances have tinted windows with covers. Bestseller with protection against mosquitoes & insects has additional ventilation above the entrance & can be attached to the side of the vehicle with clips. The sewn-in floor pan can be attached to the bumper with Velcro. The window in the roof can still be used as a skylight.

The large interior is suitable for a camp bed, bicycles, dog area, changing room, shower tent, etc. The rear tent is pulled over the open tailgate and attached to the vehicle and floor.

Scope of delivery: Rear tent incl. pegs, guy line, stuff sack, 2 pitching poles

936290 269,-

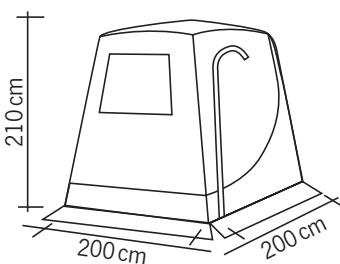
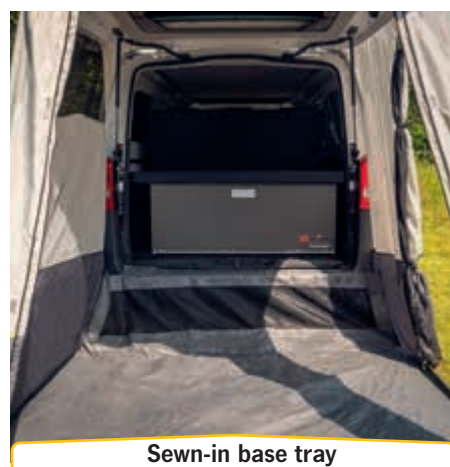

- 190T ripstop polyester
- UV protection coated
- 3.000 mm
- Flame retardant
- without linkage
- app. 4,5 kg
- app. Ø 30 x 60 cm

Update - Quick set-up rear tent for Mercedes Vito, Marco Polo & V-Class from YOC. 2015

for Mercedes Vito, Marco Polo and V-Class from YOC. 2015

- No linkage required
- Low weight, small pack size
- PVC windows in the roof
- Space for a camp bed
- Changing room or shower tent at the bathing lake
- For Mercedes Vito with tailgate

The perfect choice for all Vito and V-Class drivers. Simply slip it over the tailgate and there is space for a camp bed, bicycle or simply to get more fresh air in the vehicle. Rear wall can be raised as an awning. Window and entrance in the side wall. The PVC window in the roof provides more light.

Scope of delivery: Tent, guy ropes, pegs, 2 pitching poles and stuff sack

Gray/light gray 936283 199,-

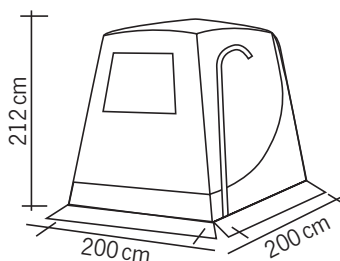

- 190T ripstop polyester
- 3.000 mm
- PU+UV-coated
- Flame retardant
- without linkage
- app. 4,4 kg
- app. 63 x 33 x 31 cm



Ventilation in the roof

Extra long airlock with doors

Uni Van 2 - universal rear tent for minicampers and vans

- Freestanding
- Side panels and rear panel with door
- Ventilation in roof and floor
- Transparent windows with 1/3 mosquito net
- Extra long airlock with doors on both sides

Universal rear tent for mini campers & vans. Both side walls and front wall with door, which can be used as awnings. Air circulation through ventilation in the roof, sides and floor. Extra long airlock with doors on both sides (140 cm). Tent can also stand freely without a vehicle. Attachment to vehicle: Simply pull it over the open tailgate & tie it off to the side with pegs.

Scope of delivery: Tent skin, poles, pitching poles, guy ropes, pegs, stuff sack.

	937984	349,-
Optional Inner tent	937985	59,95
Replacement rods, 1 each:		
Fiberglass rod	937986	9,95
Steel rod	937987	9,99

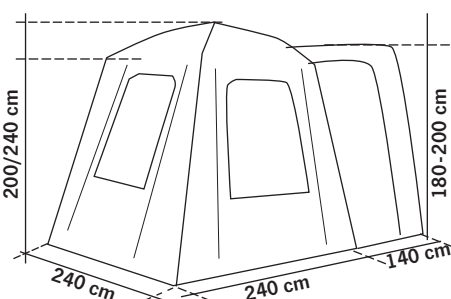

100% polyester 190T	3.000 mm	Seams sealed	Steel/fiberglass 19 mm
PU+ 2x UV coated	Flame retardant	app. 15 kg	app. 70 x 21 25 cm





Inflatable universal rear tent for buses

Uni Van Air - Inflatable universal rear tent with dome roof

- Freestanding rear tent
- Side walls and rear wall with door and 1/3 mosquito net
- Top ventilator and transparent windows
- Extra long airlock with doors on both sides
- With tent floor (Velcro fastening)

Cross dome roof rear tent with air tube technology, quick and easy to set up! Both side walls and front wall with door, which can also be used as awnings. Air circulation through ventilation in roof & floor. Extra long airlock with doors on both sides (140 cm). Attachment to vehicle: Simply pull it over the open tailgate and tie it to the side with pegs. Floor is simply attached with Velcro. Separate floor for the airlock with integrated wind protection to the bumper.

Scope of delivery: Tent skin with air tube, groundsheet, air pump, guy ropes, pegs, stuff sack, 2 pitching poles.

	937981	579,-
① Optional inner tent	937988	75,-
Spare air hose	937989	119,-



579,-

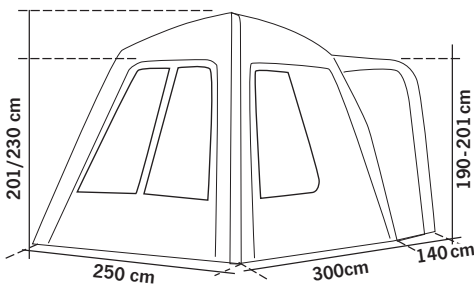

Freestanding

Matching: Air mattress for 2 persons

With built-in foot pump, can also be inflated with an air pump (not included in scope of delivery).

Soft surface made of high-quality 210T polyester ripstop with TPU.

Dims.: W 138 x L 200 x H 10 cm

Weight : 1,8 kg

Pack size: Ø 18 x app. 43 cm

930881 79,95



With tent floor for zipping in



Ventilation in the roof



Compact universal awning for minicamper



289,-

Floor ventilation



Mounting height: 170 - 190 cm



Tour Compact 2 - Tunnel tent for mini campers & vans

- Freestanding
- Both side windows with 2/3 transparent PVC + 1/3 mosquito net - with outer cover
- Bottom ventilation on both sides and 2 top vents in the front
- Large front door (width 140 cm), which can be rolled up or used as an awning
- Door in rear wall (width 180 cm) can be rolled up on both sides, with 1/3 mosquito net
- Roof poles for more stability prevent water pockets in the rain
- Concealed zippers
- Front with 2 side transparent windows with inner cover
- Vehicle connection: piping Ø5+8mm, lock bar, tensioning loops

Tour Compact suitable for:

- Volkswagen Caddy
- Mercedes Citan
- Renault Kangoo
- Ford Connect, KR + LR
- Citroën Berlingo
- Peugeot Partner

The new 1-tunnel awning "Tour Compact 2" impresses with proven & new optimized details.

Scope of delivery: Tent skin, 2 fiberglass poles, 3 roof reinforcement poles (steel), 1 lock pole (steel), 2 pitching poles (steel), pegs (steel), guy ropes, packing bag

937013 289,-

Accessories:

Inner tent for Tour Compact 2

2 additional sleeping places, dims.: W 140 x L 200 cm

937014 39,95



Attachment to the vehicle:

- Piping Ø 5+8 mm
- Locking bar
- Anchor loops

75D-190T polyester

3.000 mm

Seams sealed

3x fiberglass 11 mm

UV protection

Flame retardant

app. 10 kg

app. 75 x 23 23 cm

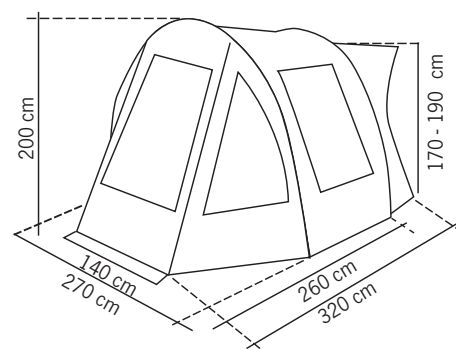

Exact fit Awning carpet for Tour Compact 2

- Waterproof underside (PEVA)
- Soft upper side (fleece)
- Pleasantly soft feel and protection against cold feet
- Provides additional insulation and enables barefoot walking
- Protects the tent floor
- Easy to clean (not washable)
- Carrying bag included

937012 39,95



RE-TENT the new collection from Reimo TentTechnology to protect our nature.



The tent fabrics are made from recycled disposable plastic bottles. Each m² corresponds app. to 3 x 5-liter plastic cola bottles or 9 x 550-ml plastic water bottles.



Mounting height: 180 - 200 cm



RE-TENT Tour Easy bus awning

Fabric made from recycled disposable plastic bottles

- Inner roof with coating to reduce the temperature in the tent
- Polyester fabric: Global Recycled Standard
- Airlock with doors on both sides

RE-TENT is the new collection from Reimo TentTechnology to protect our nature. The tent fabrics are made from recycled disposable plastic bottles. The TOUR EASY requires app. 40m².

Tent retains all features of current TOUR EASY 4 (Art. 936550), but in addition to the recycled tent fabric in the roof, it has a black inner coating to reduce the incidence of sunlight and thus also the temperature inside the tent.

Dims.: W 300 x D 270+90 x H 180-200 cm

Pack size:

app. Ø 25 x 80 cm / weight: app. 14 kg

Scope of delivery: Tent skin, 2 fiberglass poles, 2 pitching poles, 1 airlock pole, guy ropes, pegs, stuff sack

9365503 339,-







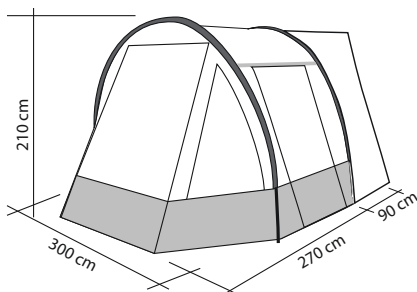



Optional Inner tent 936558 48,95

Optional Tent floor 9365581 29,95

Spare rod fiberglass 9365582 9,95



RE-TENT
You can find more models from our RE-TENT series on page 23

	 185T 68D recycled polyester	 3.000 mm	 Seams sealed	 Fiber/Alu Ø19/22mm
 Piping Ø 5+8 mm	 UV protection	 Flame retardant	 app. 14,2 kg	 app. Ø 25 x 80 cm

Universal bus awnings



Mounting height:
180 - 200 cm



Tour Easy Young 2 - best price Bus awning

- Large front door and side door can be rolled up or used as an awning
- Side windows with 1/2 mosquito net and 1/2 transparent PVC
- Side window in front with inner cover
- Large D-shape door in rear wall



229,-

The entry-level model for campers. 1-tunnel awning for vans with a large door in front, which can also be used as sun awning. In both sides window with 1/2 mosquito net and 1/2 transparent PVC. Additional door in right-hand side wall (can also be used as awning), D-shape door in rear wall (can be opened on one side) & airlock (45 cm).

Incl. 3 roof reinforcement rods for more stability and to prevent water pockets when it rains.

Vehicle connections: Piping Ø 5 + 8 mm, lock bar or loops for fixing with tensioning lines

Scope of delivery: Tent, 2 fiberglass poles, 2 pitching poles, 3 roof reinforcement poles, 1 airlock pole, guy ropes, pegs, carrying bag

	936556	229,-
Optional Inner tent	9365561	39,95
Spare linkage	9365562	19,95

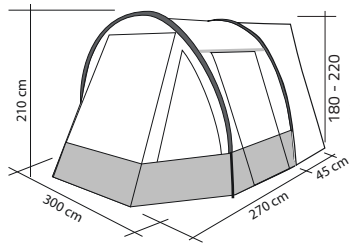

Piping Ø 5+8 mm	185T Polyester	3.000 mm	Seams sealed	Fiber/steel Ø19/22mm
UV protection	Flame retardant	app. 11 kg	app. 67x 22 x20 cm	



349,-



Mounting height:
180 - 200 cm



Tour Easy 4 - Compact awning with high comfort

- Large front with mosquito net
- Lock can be opened on both sides
- Mosquito net in both side walls
- With practical opening for power cable
- Optional inner tent and floor available

Tour Easy 4 offers a high level of comfort and impresses with the following new features: The front has an additional mosquito net insert, windows in side walls are equipped with 1/3 mosquito net and 2/3 transparent PVC windows with inner cover.

A power cable can be routed through a practical opening on the floor fan. The airlock to the vehicle impresses with openings on both sides.

Vehicle connection: Piping Ø 5 + 8 mm, lock bar or loops for fixing with tensioning lines

Scope of delivery: Tent, 2 fiberglass poles, 2 pitching poles, 3 roof reinforcement poles, 1 airlock pole, tensioning ropes, pegs, carrying bag

	936550	349,-
Optional Inner tent	936558	48,95
Optional Tent floor	9365581	29,95
Spare rod fiberglass	9365582	9,95

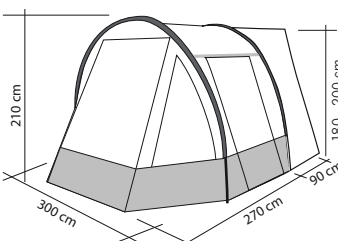
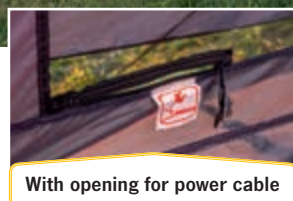

Piping Ø 5+8 mm	185T Polyester	3.000 mm	Seams sealed	Fiber/Alu Ø19/22mm
UV protection	Flame retardant	app. 14,2 kg	app. Ø 25 x 80 cm	



Mounting height: 180 - 200 cm



Well-equipped and spacious TOUR ACTION 7

Tour Action 7 -
Bus awning with plenty of space

- Freestanding
- Optional hook-in groundsheet & inner tent available
- Both side windows with 2/3 transparent PVC + 1/3 mosquito net - with outer cover
- Bottom ventilation on both sides and 2 top vents in the front
- 90cm airlock with doors on both sides
- Large front door that can be rolled up or used as an awning
- Door in rear wall can be rolled up on both sides, with 1/3 mosquito net
- Roof poles for more stability prevent water pockets in the rain
- Concealed zippers
- Front with 2 side transparent windows with inner cover

The spacious 2-tunnel awning "Tour Action 7" impresses with proven and new optimized details.

Scope of delivery: Tent skin, 3 fiberglass poles, 3 roof reinforcement poles (steel), 1 airlock pole (steel), 2 pitching poles (steel), pegs (steel), guy ropes, packing bag
900784 379,-

Optional inner tent: Enables 2 add. sleeping places in awning, dims.: W 140 x L200 cm
900786 39,95

Optional, hook-in Tent floor
900785 19,95



Floor ventilation



Very spacious

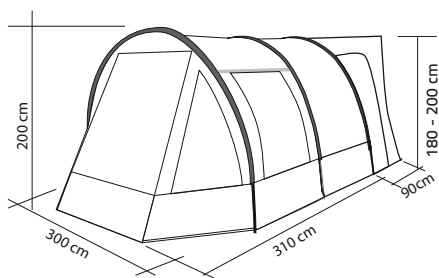

Attachment to the vehicle:

- Double piping Ø 5+8 mm
- Locking bar
- Anchor loops

75D-190T polyester

3.000 mm

Seams sealed

Steel/Fiber Ø19/11 mm

UV protection

Flame retardant

app. 19 kg

app. 75 x 26 x 37 cm

Inflatable, universal bus awning



TOUR EASY AIR



Mounting height:
180 - 200 cm



529,-

Tour Easy Air - Air awning for camper vans

- Air technology
- Large front door with mosquito net
- Small pack size, low weight
- Vehicle airlock with doors on both sides
- Practical opening for power cable
- Optional tent floor

Suitable for e.g. Volkswagen T6, Renault Traffic, Mercedes Vito, Citroën Spacetourer etc.

The classic: 1-tunnel awning now with air technology. The large front door is additionally equipped with mosquito netting. Additional door in the rear wall with 1/3 mosquito net and 2/3 transparent PVC film. Front door and side door can also be used as awnings.

90 cm airlock to the vehicle with doors on both sides, floor ventilation, mosquito net in the rear wall (can be opened on both sides).

Vehicle connection: Piping Ø 5+8 mm.

Lock rod + loops for fixation with tensioning lines or suction cups.

Scope of delivery: Tent with 2 air tubes, 2 pitching poles, 3 roof reinforcement poles, 1 airlock pole, guy ropes, pegs, air pump, carrying bag

936559 529,-

Optional Inner tent 936558 48,95

Optional Tent floor 9365591 24,95

Spare air hose 9365592 49,95

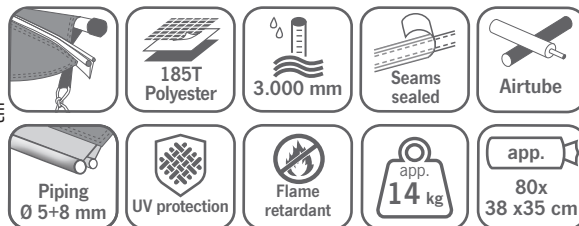
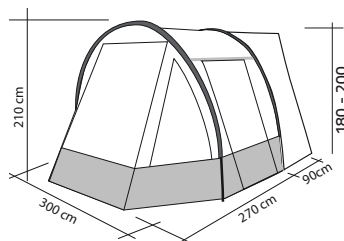

Optional awning carpet

for Tour Easy Young 2, Tour Easy 4, Tour Easy RE-TENT & Tour Easy Air

Waterproof underside (PEVA) and soft upper side (fleece) for a pleasantly soft feel and protection against cold feet. Protects the tent floor and is easy to clean (not washable), incl. carrying bag

936547

44,95



Air mattress for 2 persons

Suitable for most inner tents. With built-in foot pump, can also be inflated with an air pump. Soft surface made of high-quality 210 T polyester ripstop with TPU.

Dims.: W 138 x L 200 x H 10 cm

Weight: 1.8 kg

Pack size: Ø 18 x app. 43 cm

930881

79,95





Inflatable awning for vans

Mounting

height:
250 - 280 cm



ONE BEAM AIR HIGH

459,-

One Beam Air High - Only one air hose for quick set-up!

- Large windows with privacy screen
- Front fully equipped with mosquito net and roll-up covers inside and outside
- New air technology with just one air hose for fast assembly
- Side panels have suction cups for attaching to the vehicle
- Includes practical carrying bag and air pump
- Vehicle connections with 5 and 7 mm piping or loops for fixing with tensioning lines.

The motorhome awning with only one air hose, with external valve. Side walls with doors and windows with curtains provide maximum privacy. Floor as a "frame" under air hoses for quick assembly. Color: gray, anthracite, lime.

Scope of delivery: Tent with air tube, pegs, pitching poles, guy ropes, air pump, carrying bag, groundsheet.

935394 459,-

Spare tube 9353941 59,99

Suction cups, 6 pieces
935396 9,99

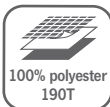
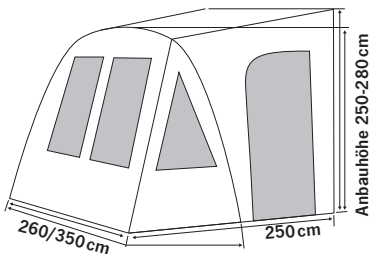

100% polyester
190T



UV protection



3.000 mm



Flame
retardant



Ø 5+7
mm



Airtube



app.
11 kg



app.
75 x 35 x
30 cm

Mosquito nets in the front





TOUR BREEZE AIR



Windows with large mosquito nets



Freestanding, easy to move away when tent is left standing



Quick and easy separation and connection of the vehicle thanks to the piping with zipper





Inflatable awnings for high buses and motorhomes



TOUR BREEZE AIR



from 569,-



3 mounting

heights:

180 - 220 cm

225 - 250 cm

250 - 280 cm



Quick and easy separation and connection of the vehicle thanks to the piping with zipper

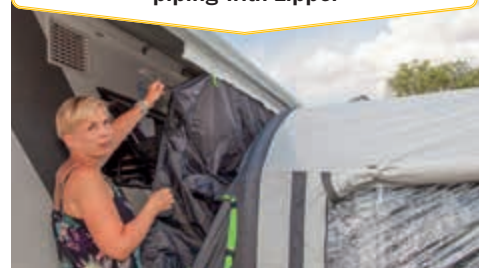

Tour Breeze Air S, M & L

- Heavy premium quality
- Keder connection with zipper for easy removal if the tent is left standing
- Freestanding
- Transparent windows with extra large mosquito net inserts
- Front door can be used as an awning
- Sewn-in PVC tent floor
- Including storm bracing and air pump
- Available in 3 heights

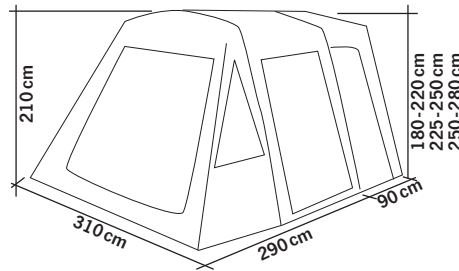

Easy and quick to set up air bus awning. The transparent windows in the front and side are fitted with large mosquito nets for optimum ventilation and an external cover. The rear wall of the airlock is also equipped with mosquito nets and can be opened completely or on one side.

Scope of delivery: Tent with air tube, tent floor, 3x roof reinforcement air tube, airlock pole, pitching poles, air pump, tensioning ropes, storm ropes, pegs, stuff sack

Size S: mounting height 180 to 220 cm
936551 569,-

Size M: mounting height 225 to 250 cm
936552 599,-

Size L: mounting height 250 to 280 cm
936553 649,-

Spare hoses

Tent: 936554 42,-
Roof reinforcement: 936555 12,75



Freestanding, easy to move away when tent is left standing





CASA AIR II



Included: foam bead and support pole for secure attachment to the motorhome

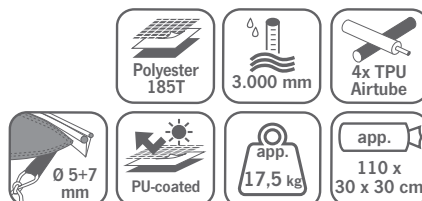
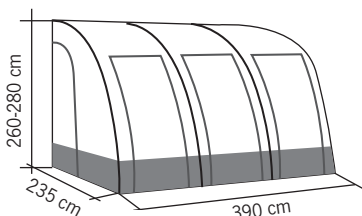

Mounting height:

260 - 280 cm



Casa Air II

- Premium air hoses
- Quick and easy to set up thanks to 4 separate air hoses
- Transparent windows
- The front sections can be rolled up or set up as an awning
- Particularly stable thanks to combination of air columns & aluminum reinforcement bars
- Including pressure bar and foam bead

The tent is particularly durable thanks to replaceable double air tubes. The front consists of 3 segments with large transparent windows.

The side sections are fitted with mosquito netting for good ventilation.

All windows have an interior cover to protect privacy.
Fcolor: light grey and dark grey

Scope of delivery: Tent skin incl. air tubes, air pump, pitching poles, foam bead and pressure poles, reinforcement poles, guy ropes, pegs, stuff sack

900035 799,-

Optional accessories:

Tent floor	9000342	49,95
Inner tent, 230 x 130 cm	9000341	52,50
Spare air hose	9000344	59,95

Air mattress for 2 people

With built-in foot pump, can also be inflated with an air pump. Soft surface made of high-quality 210T polyester ripstop with TPU. Dimensions: 138 x 200 x 10 cm

930881 79,95

For tent fastening see page 64



MARINA AIR HIGH



Marina Air High 390

Mounting height: 260 - 280 cm

Marina Air High 330 & 390

- Single-point inflation system
- High-quality premium material
- Front panels completely removable
- Mosquito net in front and sides
- Double-stroke air pump included

Marina Air High motorhome air awnings in classic design with just one air hose for quick assembly & disassembly in premium quality. The front with 3 large windows consists of 3 layers (transparent PVC, mosquito net and inner cover) and can be opened completely. In addition, all front panels can be removed or used as awnings. The side walls have a door and a mosquito net window with cover on the outside.

Scope of delivery: Tent skin with 3/4 air tubes, 2/3 reinforcement poles, 2 pitching poles, ladder guy ropes, pegs, guy ropes, air pump, carrying bag



Model	app.	app.	Item no.	Price
Marina Air High 330	26 kg	80 x50 x 40 cm	93822	999,-
Spare hose Marina Air High 330			E938220	175,-
Marina Air High 390	28 kg	80 x50 x45 cm	93823	1099,-
Spare hose Marina Air High 390			E938221	190,-

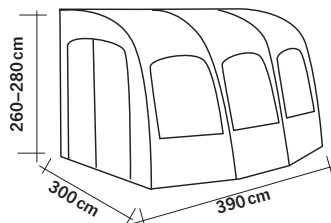
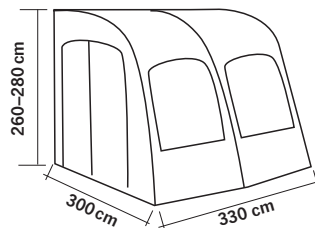

Large transparent window with mosquito net

Attachment to the vehicle:

- Double piping Ø 6+8 mm
- Anchor loops

- 300D Oxford Polyester
- 3.000 mm
- Flame retardant
- UV protection 50+
- Airtube

FREESTANDING QUICK ASSEMBLY AIR TENT FOR MOTORHOMES



Step 1



Step 2



Step 3



Step 4



Rear wall with mosquito net



Storm bracing



Single-point inflation system

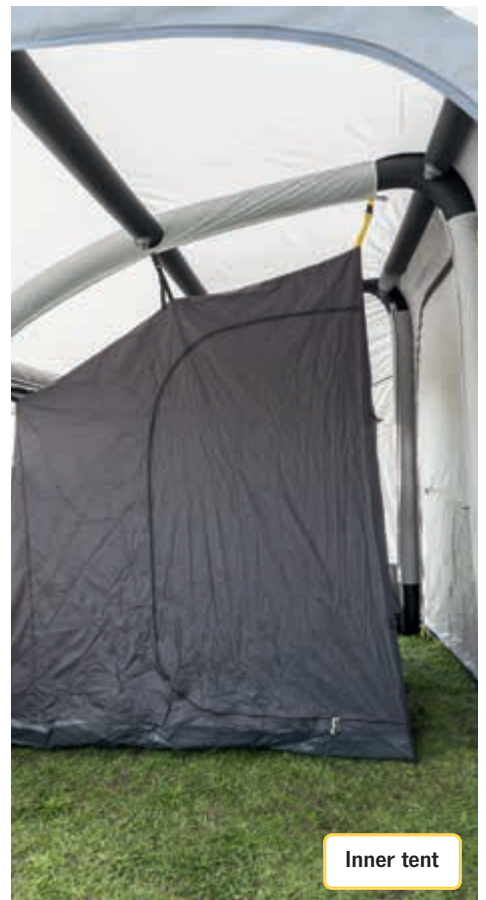

Inner tent



TOUR PONZA AIR



Mounting height:
265 - 295 cm



Tour Ponza Air 390- motorhome tent

- Freestanding All-season tent
- Single point inflation - System
- high-quality TPU air hoses
- Front and side panels with mosquito-net and completely removable
- Vehicle connection Ø 5+7mm piping

Stay mobile! The free-standing TOUR PONZA 390 motorhome air awning allows you to drive away with vehicle and leave awning standing. The 3 main vertical & 2 front horizontal roof reinforcement air hoses are connected to each other as a SINGLE INFLATION system. 4 additional horizontal air hoses can be inflated separately and provide stability. The high-quality 300D Oxford Ribstop polyester material also makes this tent suitable as a year-round tent. The front and side sections have transparent windows with external covers & mosquito netting, & can be rolled up or completely removed. The airlock is 80 cm and can be closed by means of a D-shape door (with mosquito net).

93825 1249,-

Scope of delivery:

Tent skin, air tube system (TPU),
4 x roof reinforcement, storm bracing, air pump,
pegs, guy ropes, packing bag
Pack size: app. 85 x 55 x 38 cm

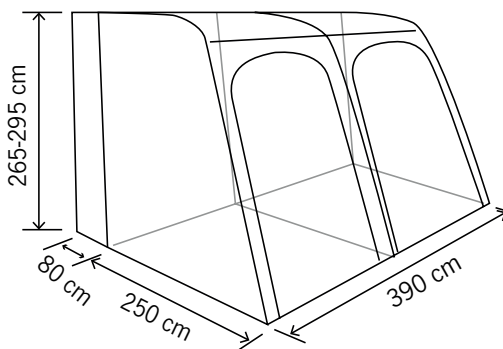

Optional accessories:

Tent floor Tour Ponza Air 390	938251	49,95
Tent carpet Villa Stripes 390 x 250cm	905171	67,95
Inner tent	938252	69,95
Travel Keder adapter (for easy driving away)	904493	31,50

Replacement hose:

Main hose center	E938253	79,95
Main hose left	E938254	79,95
Main hose right	E938255	79,95
Front roof cross hose	E938256	34,95
Rear roof cross hose	E938257	29,95

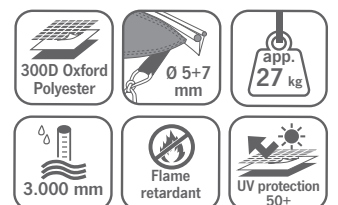

Inflatable roof tent



Inflatable mattress



Keder infeed in platform



Sky for more cosiness



2 external valves for easy inflation



Velcro connection between tent skin and mattress

Optional accessories for Bendigo Air:

Thermocover for Bendigo Air-

Provides warmth in cold weather. Easy to install inside the roof tent using clips. Quickly removable. Supplied in a pack sack. Weight: approx. 2.5kg

9006291 129,-

Sun canopies Charlyne 1.8 (without image)

(is pulled into the platform under the mattress in a piping rail) 90066 84,95



Optional accessories for all roof tents:

Car door step with folding hook (see photo):

- Facilitates the opening & closing of roof tents
- For easy access to the vehicle roof
- Ideal for loading or cleaning the vehicle roof
- Loadable up to app. 120 kg

Material: Metal, powder-coated.

With rubber lip to protect vehicle paintwork.

Color: black, dims.: LxWxH 16.1 x 7.6 x 1.6/8.4 cm, weight: 0.3 kg.

900060 14,95



You can find more spare parts at www.reimo.com



BENDIGO AIR



Mounting on vehicles equipped with base carriers. Please take the maximum roof load of the vehicle into account.

Bendigo Air - Air roof tent

- Large sleeping area for 2 people (L 220 x B 140cm)
- 2 doors and 2 windows with canopy
- Mosquito net on all openings
- For cars, vans, SUV's
- Tarpaulin protects during the journey
- Roof lining for more comfort
- Comfortable 1.40 m wide mattress, small pack size

The new roof tent is supplied complete with an aluminum roof platform. This is mounted on the vehicle so that the inflated mattress can then be pulled into the rail of the platform using the piping. The tent skin is fixed to the mattress and can then be easily inflated with the pump supplied. This is done very quickly thanks to the one-point inflation system. The ladder is then secured and the roof tent is ready for use. Deflation is very quick thanks to the 2 valves, the tent and inflated mattress can remain on the platform and are protected by a tarpaulin during the journey. The roof tent and mattress can be quickly removed from the platform and stowed in the carrying bag (app. 90 x 55 x 43 cm), giving you the choice of leaving the roof tent on the roof while driving or stowing it in the vehicle. All windows and doors are fitted with mosquito nets and have a canopy that can be set up quickly. The interior headliner supplied provides more comfort, conceals the roof structure and reduces condensation. A soft mattress topper for even more sleeping comfort is also included. Guy loops are provided at the corners of the roof tent. The roof tent can also be used without a platform and vehicle on the ground.

Ladder load capacity: max. 150 kg

Tarpaulin material: 600D Oxford + coated PVC (weatherproof)

Tent skin: Color: anthracite/light grey,

Material: 210D rip-stop polyester with one-point inflation system, weight app. 8 kg

Mattress:

Color: light grey, L 220 x W 140 x H 10 cm (polyester), weight app. 12.5 kg

Roof platform: L 220 x W 140cm (aluminum), weight app. 18kg

Platform: L 194 x W 121cm (5 cross struts, 2 longitudinal struts with 52cm spacing), max. load 250kg

Closed height app. 25 cm

Ladder: W 45 cm x L 71-233 cm (aluminum), weight app. 5.7 kg

Overall dimensions: L 220 x W 140 x H 115 cm / weight app. 51kg

Scope of delivery: Roof platform, tent skin, inflatable mattress, mattress pad, telescopic ladder, cover, roof lining, hand pump, electric pump, pegs, Window tensioning bars, panniers, fastening material

900629

1799,-





WALLABY 2

1299,-



Wallaby 2 roof tent - Softcover roof tent

- High-quality canvas fabric
- Practical roof tent for cars, vans and SUVs
- With weatherproof rain cover
- Including mattress and aluminum ladder
- 2-3 sleeping places
- Utensil pockets on the side
- Mosquito net in all tent openings
- Incl. Tension rods for windows
- PVC tarpaulin protects during the journey

Bedroom for 2-3 people on the roof of the car, van or SUV can be opened up quickly. Mosquito net in all tent openings offers protection from annoying insects. Weatherproof hood protects against rain & moisture.

The stable base is made of insulated aluminum plates.

A robust tarpaulin made of 100% PVC protects against rain and dirt during the ride. The roof tent is supplied with a comfortable 6 cm thick mattress (with removable, washable cover) under a 3D mattress base for optimum ventilation, an aluminum telescopic ladder and tensioning poles with which the side openings can be set up.

Material: Tent: 280 g/m² Rip stop canvas/canopy: 200D polyester (weatherproof), tarpaulin: 1000 D PVC (waterproof)

Dims.: Open L 240 x W 140 x H 130 cm, closed L 120 x W 140 x H 30 cm
Sleeping area: 230 x 135 cm

Weight: app. 55 kg, load capacity: 300 kg

Load capacity: roof tent: 300 kg/ladder: 150 kg

Scope of delivery: Roof tent, telescopic ladder max. 200 cm (aluminum), mattress (Sponge), 3D mattress base, fastening material, 8 tensioning poles, tarpaulins. (Note: distance between the mounting rails is 80 cm)

Wallaby 2 roof tent **900633** **1299,-**



Optional accessories:

Ladder extension 54 cm (see photo ①)	900631	54,95
Roof tent extension (see photo ②) W 120/150 x D 140/230 x H 180cm	9006331	179,-
Thermo Cover	9006332	149,-



Victoria roof tent - Folding tent with covered entrance

- Ready for use in a few simple steps
- Weatherproof
- For cars, vans and SUVs
- 1-2 sleeping places
- PVC tarpaulin protects during the journey
- Including mattress and aluminum ladder
- Hook in the roof for e.g. light
- With 2shoe pockets at the entrance, storage bag inside

Roof tent in a new design for manual opening - suitable for cars, vans and SUVs. The roof tent is quickly unfolded. Mosquito nets in all tent openings offer protection from annoying insects. The underbody consists of a solid aluminum frame. There are also two practical pockets at the entrance where shoes can be stored. The roof tent is supplied with a comfortable 7 cm thick mattress (with removable, washable cover) and an aluminum telescopic ladder (max. 230 cm).

Material:

Tent: 220 g/m² Polyester (PU coated),
canopy: 200D polyester (weatherproof), tarpaulin:
PVC (waterproof)

Dimensions:

Opened L 212 x W 132 x H 102 cm,
Closed L 107 x W 132 x H 25 cm
Sleeping surface 200 x 115 cm
Weight: app. 50 kg (including ladder)
Load capacity: roof tent: 250 kg/ladder: 150 kg
Color (tent and tarpaulin): Gray

Scope of delivery:

Roof tent with aluminum frame, telescopic ladder (max. 230cm, aluminum), mattress (Polyester), fastening material, Tarpaulin

Victoria roof tent

900634

1699,-



Air Pavillon / Party Shelter

LINOSA



Linosa air pavilion/party shelter

- Only 1 air hose
- Incl. 4 side panels
- 4 different sizes
- For camping, garden, party, etc.
- Standing height app. 215 cm, entrance height app. 170 cm
- Side panels can be ordered separately for optimization according to your wishes
- Side panels are attached with hooks and Velcro
- Roll-up door in side wall with zipper
- Equipped with hooks in the roof, e.g. for lamp

Scope of delivery: 1 pavilion with 1 TPU air tube, air pump, 4 side walls: 2x with mosquito net, 1x closed, 1x with zipper door, pegs, guy ropes, packing bag.

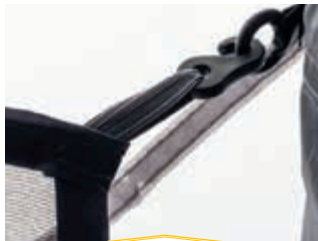

Easy installation of the walls



Including 4 side walls: 2x with mosquito net, 1x closed and 1x with door



One point inflation

Air pavilion/party shelter model	Size in cm	Weight	Item no.	Price
LINOSA 250	250 x 250	app. 9 kg	905576	319,-
LINOSA 300	300 x 300	app. 10 kg	905577	369,-
LINOSA 350	350 x 350	app. 11 kg	905578	419,-
LINOSA 400	400 x 400	app. 12 kg	905579	459,-



Lamp cable can be routed in the air hose cover

Additional accessories	LINOSA 250		LINOSA 300		LINOSA 350		LINOSA 400	
	Item no.	Price	Item no.	Price	Item no.	Price	Item no.	Price
Side panel closed	9055761	17,95	9055771	19,95	9055781	21,95	9055791	23,95
Side panel with door	9055762	21,95	9055772	24,95	9055782	27,95	9055792	29,95
Side wall with mosquito net	9055763	18,95	9055773	19,95	9055783	21,95	9055793	23,95
Spare hose set	9055764	59,95	9055774	64,95	9055784	74,95	9055794	79,95



Roofing / Vehicle connection for LINOSA pavilion

Flexible roofing for the vehicle
Incl. 4 side panels

- Suitable for all vehicle heights
- Protects from rain and sun
- Double piping Ø5+8mm, lock bar tunnel
- quick and easy to install

The vehicle connection is a canopy from the pavilion to the vehicle with the possibility of getting into the vehicle dry, e.g. in the rain.

Color: Light grey,
Material: Polyester

Roofing / vehicle connection for:

LINOSA 250 pavilion	9055795	24,95
LINOSA 300 pavilion	9055796	27,95
LINOSA 350 pavilion	9055797	29,95
LINOSA 400 pavilion	9055798	32,95



Connection - LINOSA pavilion

Protection from rain, sun, wind and cold

- Simple attachment with hooks and Velcro

The fastening options of the side walls are used to create a connection between 2 pavilions. This protects you from rain, sun, wind and cold and extends your pavilion. You can connect an infinite number of pavilions to create a large party location or an oasis of calm.

Connection for:

LINOSA 250 pavilion	9055799	29,95
LINOSA 300 pavilion	9055800	32,95
LINOSA 350 pavilion	9055801	34,95
LINOSA 400 pavilion	9055802	37,95

Camping tents/family tents



from **194,25**



Scope of delivery: Tent incl. floor, 2 sleeping cabins, fluorescent guy ropes
Dakota Z5 Deluxe 900071 224,25

Additional smaller version of Dakota Z5 with same equipment & the following dims.:
 W 280 x H 200 x D 480 cm, pack size 69 x 50 x 19 cm, weight app. 16.45 kg
Bregenz 2 Z5 900070 194,25



Dakota Z5 Deluxe & Bregenz 2 Z5 Exclusive 4 person camping tents

- High-quality premium workmanship
- Professional boom system with color coding
- Thermo double roof with roof ventilator
- Tent floor retractable with zipper
- 2 comfortable sleeping cabins with optimum roof ventilation



Polyester 210T + UV	Seams sealed	2.000 mm	Fiberglass/steel
100% PES breathable	100% polyethylene	18,1 kg	app. 78 x 33 x 29 cm

Comfort model for demanding tent fans. It offers enough space for 4 people: 2 sleeping cabins for 2 people each and an airy living area. Generous windows with sun protection & the sophisticated air conditioning system combined with refined details offer the highest possible level of comfort. Premium workmanship, high-quality materials, color-coded pole routing and an attractive exterior design mean you will enjoy this tent for a long time.



239,25



Silvretta 2 Z6 – Spacious 5-person tent with thermal double roof

- Particularly spacious living space with headroom
- 2 sleeping cabins, for 3 and 2 persons
- Zip-in groundsheet and thermal roof
- Top price-performance ratio



Spacious and comfortable tent for families of 5. High-quality details offer you a luxurious feeling of space at a great price-performance ratio. Good ventilation thanks to the numerous vents, 3 large windows (some with mosquito nets) and the thermal roof. Side door with weather protection, tent floor can be raised in the doors. Sleeping cabin with mosquito net doors. Scope of delivery: Tent incl. groundsheet, 2 sleeping cabins, guy ropes
900100 **239,25**

Polyester 190T+2xUV	Seams sealed	2.000 mm	3 fiberglass/2 steel
100% PES breathable	100% polyethylene	20,65 kg	app. 69 x 50 x 21 cm

Camping tents/Equipment tents/Shower tents/Kitchen tents

Beaver Creek - 5 person tent

- With standing height of 1.90 m
- With pockets inside for handy storage
- Outer tent with 2 windows

Dome tent with extended vestibule ideal for families and groups. One cabin for 5 people, standing height 190 cm. Practical organizers in the sleeping cabin provide optimum storage space for small items. Inner tent can also be pitched without an outer tent as the poles are on the inside. Ideal for very warm summer nights. Outer tent has 2 transparent film windows.

Scope of delivery: flysheet, inner tent, groundsheet, pegs, guy ropes, fiberglass poles, packing bag

900025 139,-

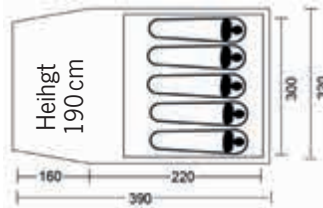

Campalto - Shower/changing tent

- Removable base
- Quick and easy to set up
- Fastening hooks in the roof e.g. for shower



Protected ventilation opening at the top enables rapid air exchange.

Inner pockets for shower gel or similar.

Frame: fiberglass,

material: 100% polyester, water column: 1000 mm.

Dims.: W 150 x D 150 cm, H 210 cm,

Pack size: 54 x Ø 12 cm,

Weight: app. 3.0 kg

901029 77,95



Malta - Shower/changing tent

- Quick and easy to set up
- Versatile use, e.g. as a shower tent or changing room

Transparent cover on top, practical storage net inside on the back wall.

Material: 100% polyester PU-coated, poles: fiberglass Ø 9.5 mm,

dims.: W 165 x D 165 x H 200 cm,

pack size: 54 x Ø 12 cm, weight: app. 3.0 kg

90108 59,95



Alicante – Kitchen / equipment tent

- Can be used as a kitchen, equipment, storage or changing tent
- Robust steel frame
- 3 large windows with mosquito net
- Large roll-up entrance door

Robust kitchen tent, can also be used as equipment tent, storage tent or changing room tent, with large entrance door (can be rolled up to the side), robust steel poles Ø19mm, large window with mosquito net & outer cover in sides, high ventilation.

Dims.: W 200 x D 190 x H 215 cm, door height 185 cm, door width 85 cm.

Material: 100% polyester (with PVC coating)/roof: PVC. Pack size: L 105 x W

27 x D 27 cm, weight: app. 16.5 kg. 901036 219,-



Inflatable windbreak



① Heligoland Air 400 - Wind and privacy protection

- Easy to set up by pumping up, no poles required
- Segments individually inflatable
- Segments can be joined together with a zipper
- Can be extended as required with optional extension segment
- Pump included

The wind and privacy screen with transparent windows consists of 2 segments of 200 cm each and has a comfortable height of 155 cm. By simply inflating the air hoses, the windbreak sets itself up almost automatically. Each segment can be inflated & used individually. All segments can be connected with zippers as required. **Scope of delivery:** Windbreak, air pump, pegs, guy ropes.

Color: Grey/Dark grey

900539

179,-

② Heligoland Air - Extension segment

- Extends the Heligoland Air windbreak by 200 cm

With transparent windows. The inflatable segment is connected with a zipper, so the windbreak can be extended as required.

Scope of delivery: Wind protection panel (without pump), pegs, guy ropes.

Color: Grey/Dark grey

900540

79,95

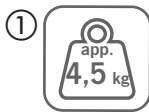

Hooge Air 480 - Wind protection with air technology

- Without poles, easy to set up by inflating
- Only 1 inflation point
- With transparent windows
- 3 parts à 160 cm
- Can be extended as required
- Optional extension segment possible, can be connected to each other as required
- Air pump included

Booms: Air hose

Material: 150D polyester

Dims.: W 480 x H 140 cm,

Weight: app. 6.5 kg

Scope of delivery: Windbreak with guy ropes, pegs, air pump and packing bag. Color: Granite/Black

① 900537 279,-

Extension segment B 160 x 140 cm

Includes guy ropes, pegs and pack bag (without pump). **Weight:** approx. 2 kg

② 900538 109,-

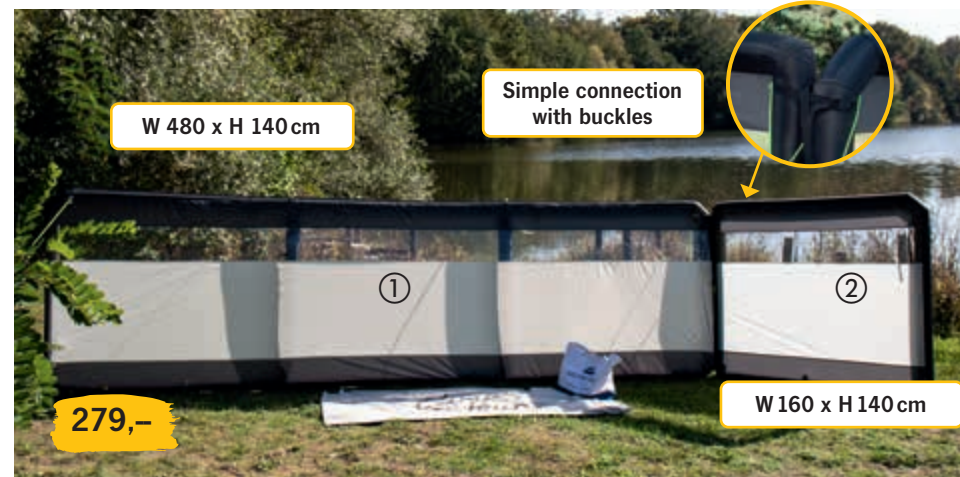

**SMÖGEN -
Windbreak 500 x 125 cm**

- Quick assembly system
- For the beach, campsite or garden
- 4 elements
- Variably positionable
- suitable for veranda function in front of motorhome, caravan and campervan
- Can be used as a wind and privacy screen

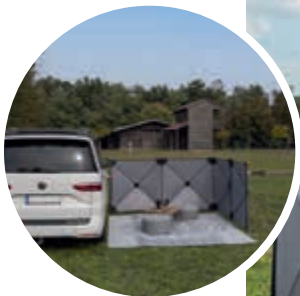

Material: 150D Oxford polyester Color: Grey
 Dims.: 500 x 125 cm,
 pack size: (L x W x H): 93x15x16 cm, weight: 1.5 kg
 Scope of delivery: wind protection, poles, guy ropes, pegs,
 packing bag **900520 119,-**



**Dune and Sylt
windbreak
500x140 cm**

- With 3 elements
- Protection from wind and prying eyes
- For the beach, campsite or garden
- Low weight
- Small pack size

Inexpensive windbreak with 3 elements without window. Protects from wind & prying eyes, incl. 4 steel uprights Ø 16mm
 Material: 190T polyester,
 dims.: 500 x 140 cm,
 pack size app. 65 x Ø 12 cm,
 weight: approx. 1.5 kg

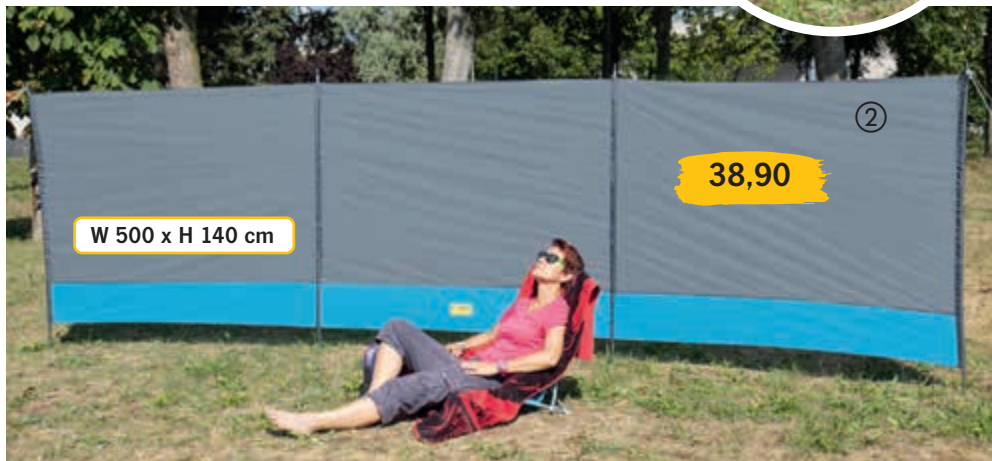

① Dune windbreak – Color: Grey/Anthracite/Lime-Green	900515	38,90
② Sylt windbreak – Color: Grey/Blue	900514	38,90

Set-up bars & Folding vacuum cleaner

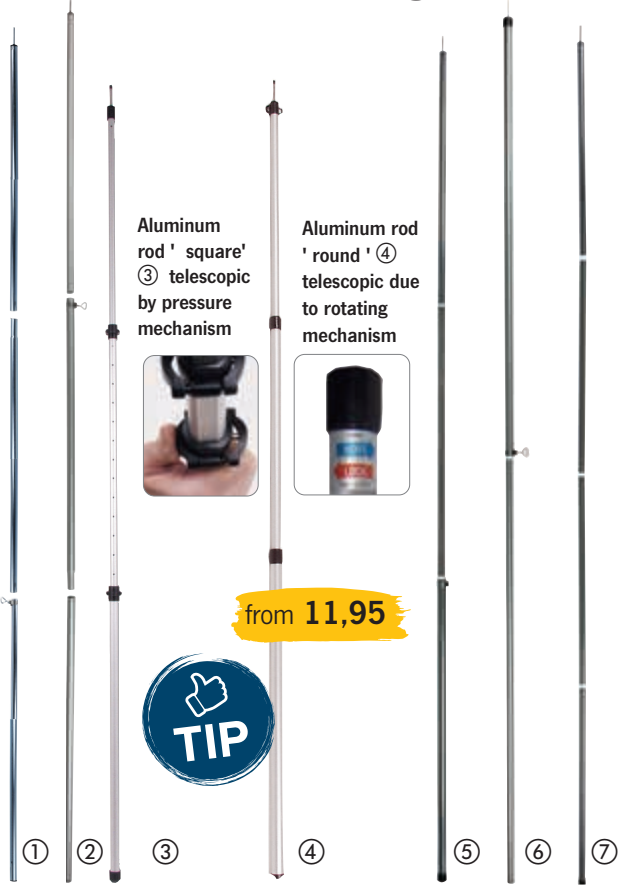

Set-up bars

- | | | |
|--|--------|-------|
| ① Steel support pole, Ø 22 mm, 3-part with screw, telescopic, length 165-250 cm | 90307 | 33,30 |
| ② Aluminum support rod, Ø 25 mm, 3-part with screw, telescopic, Length 170-260 cm | 903070 | 28,95 |
| ③ Luxury aluminum telescopic pole square with push button for locking Ø 30 mm, 3-part, app. 95 - 230 cm, pack size 96 cm | 903682 | 27,95 |
| ④ Luxury Round aluminum telescopic pole with rotating mechanism for locking, Opened, extended and locked with a twist. Ø 30 mm, 3-part app. 95 - 230 cm, pack size 96 cm | 90370 | 19,95 |
| ⑤ Support rod Ø22 mm, 3 parts, 2 pcs. 180-220 cm, steel, telescopic | 903077 | 24,95 |
| ⑥ Support rod Ø22 mm, 2 parts 110-200 cm, steel, telescopic | 903071 | 21,40 |
| ⑦ Set-up rod, 4 pieces, 2 pcs. 196 cm, steel, not telescopic | 903076 | 14,95 |
| ⑧ Smartlock tent pole clamps 4 pieces per pack incl. pin wrench, screwless locking system. No damage to the tent poles. For steel and aluminum. Ø22/19 mm | 91975 | 11,95 |
| Ø28/25 mm | 91976 | 13,95 |



All bars only available in self-service packaging.

Additional tent poles

- | | | |
|--|-------|-------|
| ① Connecting rod Ø 22 mm
2-part, telescopic, steel, tube clamp, tube clamp, tent pole base length 250 cm | 90362 | 12,95 |
| ② Roof support bar Ø 22 mm
With tube clamp on both sides, aluminum
Length 025-040 cm, 2-part | 90334 | 17,95 |
| Length 170-250 cm, 3-piece | 90337 | 22,95 |
| ③ Spacers Ø 22 mm – 1-piece, gable/ridge extension of awning frames, aluminum, length 90 cm/ usable length 80 cm | 90332 | 8,95 |
| ④ Roof hook pole (ridge pole) Ø 25 mm
3-part, with hook & pipe clip, aluminum
Length 170-260 cm | 90358 | 29,95 |
| ⑤ Clampingrod/lock
rod for minicamper, 255 cm long. | 99444 | 8,40 |

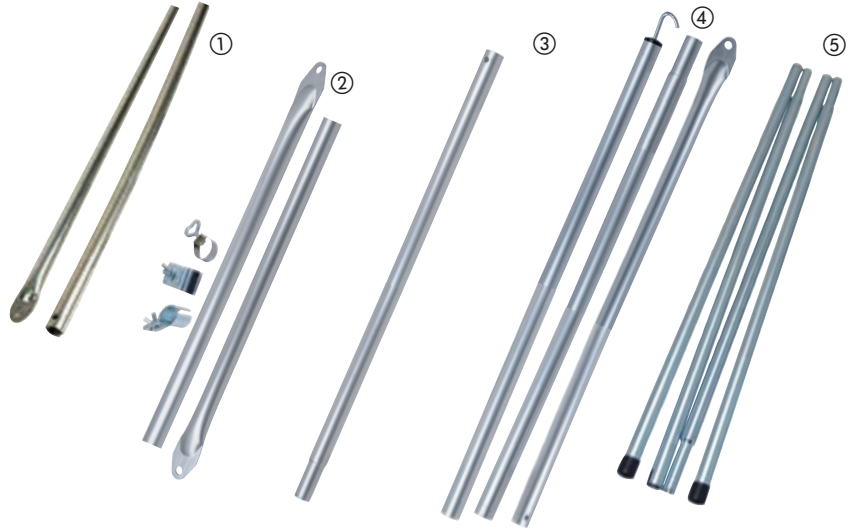

Awning fastening without drilling with hinged suction cups

For screwless attachment of canopies, awnings, etc. Place suction cup on a smooth, clean & dry surface & move the lever.



Proven for 10 years

Plastic folding suction cup

With sturdy hook. Ø 100 mm. Loadable up to app. 10 kg

1 pc.	93648	11,95
Ø 120 mm. Loadable up to app. 15 kg		
1 pc.	936480	17,50



Folding suction cup cast aluminum,

Ø 120 mm Plate made of natural rubber Suction disk Ø 120 mm, loadable up to app. 10 kg with screw thread for various suction cups. Fastenings. Made in Germany

1 pc.	93647	48,70
-------	-------	-------



Folding suction cup for attaching the

Ø 55 mm sluice pole Loadable up to app. 8 kg. Without tube holder,

1 pc.	93646	41,95
-------	-------	-------



Folding suction cup with ring + 2 S-hooks, Ø 115 mm

The suction cup is simply placed on a smooth, clean & dry vehicle surface & then the lever is flipped. Loadable up to 10 kg

1 pc.	936471	9,95
-------	--------	------

Awning accessories



Quick Lock Padset

Caravan awning fastening without drilling, screwless bracket
 2 pieces underside smooth **935076** **10,95**
 2 pieces underside heel **935077** **10,95**

Awning clips

- Attachment to the caravan without drilling
- Screwless fastening
- Variable use
- 3 pieces gray/black **935080** **9,95**

Dimensions: 48 mm, 65 mm



Fix on II fitting

Screwless caravan fitting. Optimized version that can also be used for caravans with integrated rails.
set of 3 for awnings **90176** **28,55**

Keder eyelets 5+7mm

- Multifunctional

The keder eyelets have a 5 mm keder on one side and a 7 mm keder on the other. Suitable for caravans, motorhomes and awnings. Can be used, for example, as a holder for storm lines, solar showers, utensil bags, coat hooks, etc. The 6-piece set should not be missing from any basic camping equipment
901693 **4,95**



Magnetic piping adapter set

Quickly & easily attach awnings with a keder connection to a vehicle without a multirail. Consisting of magnetic tape with piping profile (length 283 cm) & 3 double piping rails, 90 cm each

43,95

1 set **904490** **43,95**

Quick Lock Pads Set

For all tents with double piping. Without drilling for Caravan awning fastening. Clamping eyes hold by tensioning the linkage
set of 3 **935074** **33,70**



Travel Keder adapter

For securely fastening your awning to the car. Length 3 m, double piping Ø5+8 mm

904493 **31,50**

For Keder Ø 5-8 mm

Locking piece Keder rail – set of 2

Prevents the keder strip from slipping out of the keder rail.
 Ø 5 mm **901271** **3,95**
 Ø 7 mm **901272** **3,95**

Locking piece keder rail

For piping strips with Ø 7mm, fixes your awning, sun awning or similar.
2 piece **901273** **7,50**

Anti-flutter Clamps for awnings, sun sails, tarpaulins, etc.

- Easy to fix
- Also available as extra wide jumbo version
- Prevents fluttering noise
- Reduces damage

① 2 pieces with 1x short and long belt each **901276** **12,95**
 ② Clamp Jumbo 1 piece extra wide **901275** **19,95**

Dimensions: 20 cm, 5 cm

from **10,90**

Roof retaining strap and storm protection

- Storm protection for awning or awning
- Particularly sturdy design, TÜV/GS tested
- Belt length 11 + 14 m - extra long
- Prevents the awning or blind from blowing up
- Complete with pegs & tension spring
- 4 cm wide black straps

Length: 11 m **432882** **10,90**
 Length: 14 m **432881** **14,90**



Tent fixing

Tent lines



① **Reflective tensioning line**
Braided storm line with three-hole tensioner and peg strap. Ø 3 mm, 3 meters long, Fb.Green
4 pieces **90367 4,60**
50 m without three-hole tensioner
1 roll **903672 9,95**

② **Tension line white 4 m** Braided storm line with three-hole tensioner and peg strap. Ø 4 mm. 4 pcs. **90287 3,95**

Bracing aids



① **Cord tensioner** Alu with 3 holes, oval, hole Ø 5.3 mm. 10 piece **44223 3,40**

② **Nylon hook** for screw mounting. 1 piece **44213 1,10**

③ **Nylon hook special** for boats & industrial use, fastening with knot on rubber rope Ø 8 mm. 5 pcs. **44212 4,90**

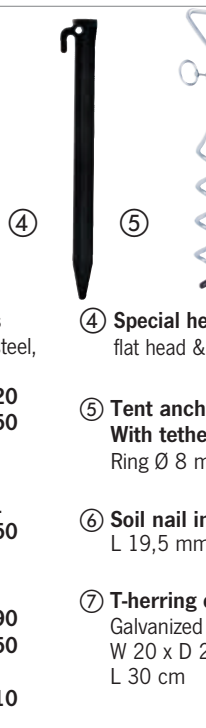

① **Rock bottom herring Tarzan 5 pieces**
With nail head & cross nail. Galvanized steel, round, Ø 6 mm.
L 17 cm **903191 3,20**
L 23 cm **903192 5,50**

② **Rock nail 4 pieces**
With plastic fastening hooks. Rock nail galvanized steel. Ø 7 mm, length 25 cm. **90299 16,50**

③ **Special plastic herring 6 pcs.** flexible, impact-resistant plastic, L 20 cm **94811 5,90**
L 30 cm **94812 7,50**
ditto loose, 1 piece
L 30 cm **94812L 1,10**

④ **Special herring extra strong plastic 6 pieces** flat head & additional eyelet, L 21,5 cm **94857 4,95**

⑤ **Tent anchor/Tethering peg – With tether ring for pets**
Ring Ø 8 mm, length 40 cm **90282 7,50**

⑥ **Soil nail in case, 20 pcs.**
L 19,5 mm. Fluorizing for Cordless screwdriver **94815 28,60**

⑦ **T-herring extra strong 2 pieces**
Galvanized steel, 3 mm thick. W 20 x D 20 mm. L 30 cm **94804 16,60**



① **Rubber mallet with wooden handle** with herring extractor, 250 g **94823 3,95**

② **Herring extractor luxury** Galvanized steel, with plastic handle. **Piece 90324 2,50**

③ **Telescopic Herring extractor, easy on the back**, extendable up to 60 cm **903241 5,95**

Bracing material



① **Ladder tensioning element, gray**
6 sections, 21.5 cm long, 2.5 cm wide. 5 piece **90289 3,60**

② **Rivet head tensioner**
Made of elastic plastic. For buttoning into punched eyelets. Pack of 5 pieces.
11 cm long **90291 3,80**
24 cm long **902911 4,60**

③ **Tent pegs** with steelhook and rubber loop 4 piece **90284 3,95**

④ **Rubber tensioner with ball**
For quick and easy tensioning of tarpaulins, pavilions, awnings, etc. Universally usable! 5 piece **902841 3,45**

⑤ **Rubber ring**
Square, hose-cut, L90 x B8 x H5 mm, 10 piece **90305 3,50**

⑥ **Jet Rope quick release** Ratchet function, for tents, wind protection, as a washing line & much more. Usable length app. 1.90 m, loadable up to max. 30 kg. **93649 7,90**

⑦ **Rubber tensioner 80-140cm** stretchable with 2 aluminum hooks, Ø 10 mm **44218 2,50**

⑧ **Rubber tensioner** Rubber cable with steel hook, 60 cm **44219 2,15**

⑨ **Rubber tensioner 35 cm** with plastic fastening hooks & caps, stretchable up to 62 cm, Ø 5 mm 4 pieces **442180 1,95**

⑩ **Rubber cable with hook** Rubber cable with plastic hook, 60 cm **44221 4,10**
100 cm **44222 9,95**

⑪ **Rubber clamps with metal hooks, Pack of 20 pieces**
Length 38 cm **442202 19,-**
Length 53 cm **442203 20,95**

Inflatable windbreak suitable for camper vans

- protects against draughts
- no piping necessary

Simply place under the vehicle and inflate (pump not included)

Material: Heavy duty PVC

Scope of delivery:

Windbreak, sewn-on tarpaulin with eyelets, pegs, carrying bag

Dimensions:

Length 250cm Ø30cm

Weight:

app. 3,2kg

Pack size:

app. 45x14x12cm

905991

129,-



Recommendation:

① Electric air pump 12 V/230 V

With 230 V transformer and 3-valve adapter

93068

22,99

② 12 V electric high-pressure air pump

Suitable for boats, air tents, mattresses, inflatable furniture, etc.

930681

59,99



Motorhome protective covers

- Reliable, water repellent weather protection
- Roof made of Tyvek-like breathable material in white for optimal UV protection
- Good ventilation, reduction of mold risk
- Made of tear-resistant 3-ply SFS fabric: roof 125 g/m², Sides 100 g/m²

Breathable and weatherproof protective cover preserves value of your motorhome. The side wall is easily opened by zipper & allows access to the motorhome.

L 500 - 550 x W 240 x H 270 cm

928091

242,-

L 550 - 600 x W 240 x H 270 cm

928092

255,-

L 600 - 650 x W 240 x H 270 cm

928093

265,-

L 650 - 700 x W 240 x H 270 cm

928094

279,-

L 700 - 750 x W 240 x H 270 cm

928095

294,-

L 750 - 800 x W 240 x H 270 cm

928096

282,-



Awning & tent carpets



TRAVEL – Awning and tent carpets

Particularly light and compact

- Protects against stones & dirt
- Material: 100% polypropylene (PP)
- Material thickness: 200 g/m²
- Lets the soil breathe
- Washable
- Mold resistant
- Durable
- 100% recyclable
- Easy to clean
- Incl. Carrier bag

Width	Weight	item No.	Price	Base price per m ²
L 260cm	app. 1,3kg	904335	59,95	GP*9,22/qm
L 290cm	app. 1,5kg	904336	64,95	GP*8,96/qm
L 320cm	app. 1,7kg	904337	69,95	GP*8,74/qm
L 370cm	app. 1,9kg	904338	79,95	GP*8,64/qm



without tarpaulin and pegs



4

PIECE

4,50

Optional accessories:

Fixing clips - set of 4

For attaching carpets, awnings, tarps and much more. Simply clip in, close and secure.

For material thickness up to max. 1.2 cm.

Material: PP

Dims.: L8.5 x W3 cm

4 piece 904489 4,50



Our awning and tent carpets

- Particularly thick and soft
- Protects against cold ground, stones and dirt
- Material: 100% polypropylene (PP), material thickness: 400 g/m²
- With UV protection
- Border edged
- Hard-wearing, rot-proof
- Easy-care, particularly easy to clean
- Loops at all corners for securing with pegs, e.g.
- Carrying bag included

HOLIDAY TRAVEL

Color: Anthracite

Width 250 cm	Weight app.	item No.	Price	Base price per m ²
L 260 cm	2,6 kg	905194	59,95	GP*9,22/qm
L 290 cm	3 kg	905195	64,95	GP*8,96/qm
L 340 cm	3,5 kg	905196	69,95	GP*8,23/qm
L 390 cm	4 kg	905197	74,95	GP*7,69/qm



LIFE IS A JOURNEY

Color: Light Grey

Width 250 cm	Weight app.	item No.	Price	Base price per m ²
L 260cm	2,6 kg	905189	59,95	GP*9,22/qm
L 290cm	3 kg	905190	64,95	GP*8,96/qm
L 340cm	3,5 kg	905192	69,95	GP*8,23/qm
L 390cm	4 kg	905193	74,95	GP*7,69/qm

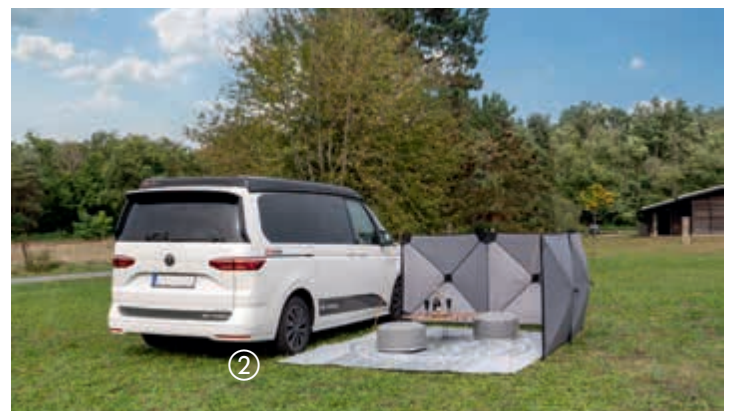

Awning & tent carpets

Width 250 cm	① Villa Ethno		
L 290 cm	90516	61,95	GP* 8,54/qm
L 390 cm	905161	83,95	GP* 8,61 /qm
L 450 cm	905162	94,95	GP*8,44/qm
L 500 cm	905163	104,-	GP*8,32/qm
L 600 cm	905164	118,-	GP*7,87/qm

Width 250 cm	② Villa Stripes		
L 290 cm	90517	49,95	GP* 6,89/qm
L 390 cm	905171	67,95	GP* 6,97/qm
L 450 cm	905172	84,95	GP* 7,55/qm
L 500 cm	905173	97,95	GP* 7,84/qm
L 600 cm	905174	108,-	GP* 7,20/qm



from **49,95**

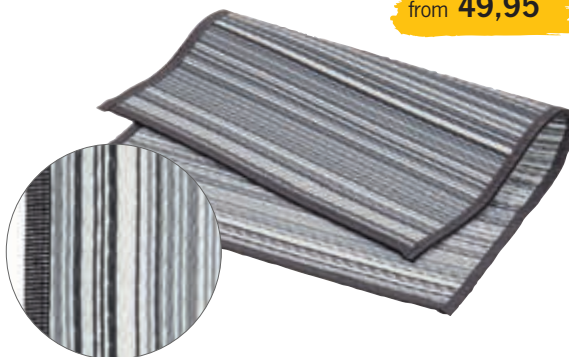

Villa Ethno, Villa Stripes awning or tent carpets in premium quality

- Material: 100% PP
- Material thickness: 400 g/m²
- Extra thick, protects against cold floors, stones & dirt
- Incl. Carrier bag
- Durable
- Rot-proof
- Easy to clean
- Border edged
- Can be used on both sides

Particularly thick
and insulating
material

Width 250 cm	① Cloud gray		
L 300 cm	905151	49,95	GP* 6,66/qm
L 350 cm	905152	59,95	GP* 6,85/qm
L 400 cm	905153	69,95	GP* 7,00/qm
L 450 cm	905154	85,95	GP* 7,20/qm
L 500 cm	905155	89,95	GP* 7,20/qm
Width 300 cm			
L 400 cm	905156	82,95	GP* 6,91/qm
L 500 cm	905157	92,95	GP* 6,20/qm

Width 250 cm	② Cloud black		
L 300 cm	905184	49,95	GP* 6,66/qm
L 350 cm	905185	59,95	GP* 6,85/qm
L 400 cm	905186	69,95	GP* 7,00/qm
L 450 cm	905187	82,95	GP* 7,37/qm
L 500 cm	905188	89,95	GP* 7,20/qm

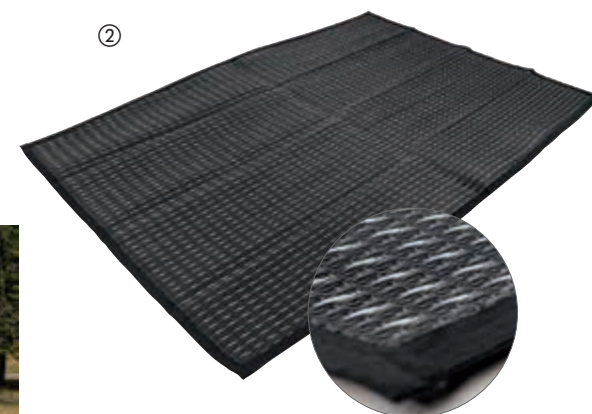
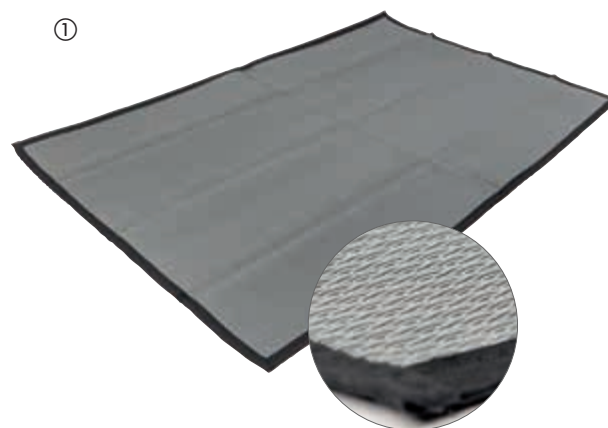

Cloud – awning or tent carpet in classic gray or black with white accents

- Low weight
- Material: 100% PP
- Material thickness: 300 g/m²
- Incl. Carrier bag
- Durable
- Easy to clean
- Border edged
- Can be used on both sides

CLOUD awning / tent carpet is particularly soft & protects against cold ground, stones & dirt. It can be used on both sides, has a bordered edge & a loop at each corner to attach it to the floor.



All rugs are
supplied in a bag



Villa Soft Light Anthracite – The timeless awning carpet for sand and gravel

- Material: 70% PVC, 30% Textilene, thickness 400g/m²
- Carrying bag included
- Indestructible synthetic fiber
- Specially coated
- Durable and easy to clean
- Rot-proof and UV-resistant
- 4 corner eyelets
- Can be cut to size
- Very comfortable barefoot

Width 2.5 m

Length	Price	Base price
4,0 m	905011 79,95	GP* 8,00/qm
5,0 m	905012 84,95	GP* 6,80/qm
6,0 m	905013 99,95	GP* 6,66/qm

Width 3.0m

Length	Price	Base price
5,5 m	905014 104,95	GP* 6,36/qm
6,0 m	905015 114,95	GP* 6,39/qm
6,5 m	905016 93,95	GP* 4,82/qm
7,0 m	905017 102,-	GP* 4,86/qm



Villa Eco - Tent carpet for grass floors

- Permeable to air
- Material: 100% polyamide, UV resistant, high tear resistance
- Material thickness: 500g/m²
- Incl. Carrier bag
- Cozy and warm underfoot with high walking comfort

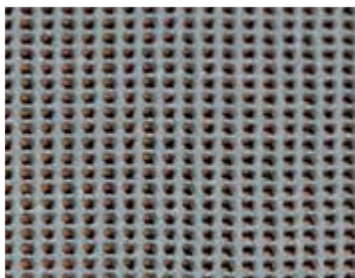

Width 2.5 m

Length	Grey	Price	Base price
3,0 m	90402	45,95	GP* 6,13/sqm
3,5 m	904020	52,95	GP* 6,05/sqm
4,0 m	904021	62,95	GP* 6,29/sqm
4,5 m	904022	64,95	GP* 5,53/sqm
5,0 m	904023	69,95	GP* 6,00/sqm
6,0 m	904024	89,95	GP* 6,00/sqm
30 m (whole roll only) x 2.5 m		905020 379,-	GP* 5,05/sqm



Awning carpets



Villa Soft Deluxe - The hard-wearing awning carpet

- Material: 70% PVC, 30% Textilene
- Material thickness: 480g/m²
- incl. carrying bag
- Indestructible synthetic fiber
- Specially coated
- Durable and easy to clean
- Rot-proof
- UV-resistant
- Can be cut to size
- Very comfortable barefoot



Villa Soft Deluxe Gray

Villa Soft Deluxe Gray width 2,5 m

Length		Price	Base price
3,0 m	90504	62,90	GP* 8,39/sqm
4,0 m	905041	82,90	GP* 8,29/sqm
5,0 m	905042	95,90	GP* 7,67/sqm
6,0 m	905043	114,90	GP* 7,66/sqm



Villa Soft Deluxe Plus

from 119,-

Extra wide

Villa Soft Deluxe Gray width 3,0 m

Length		Price	Basic priceprice
5,5 m	905044	125,90	GP* 7,63/sqm
6,0 m	905045	134,90	GP* 7,49/sqm
6,5 m	905046	154,90	GP* 7,94/sqm
7,5 m	905047	164,90	GP* 7,33/sqm
8,0 m	905048	186,90	GP* 7,79/sqm

Villa Soft Deluxe Plus Gray/anthracite, width 3,5 m

Length		Price	Basic priceprice
5,0 m	905051	119,-	GP* 6,80/sqm



Villa Soft Deluxe Blue

Villa Soft Deluxe Blue, width 3.0 m - for large awnings

Length		Price	Base price
6,5 m	904165	80,20	GP* 4,11/sqm
7,5 m	904166	89,20	GP* 3,96/sqm
8,0 m	904167	97,50	GP* 4,06/sqm

Tent carpets/all-purpose tarpaulins



Water protection tarpaulin

- Material: 100% PVC
- Dry awning in heavy rain

This practical groundsheet prevents water from entering the tent. 4 separately inflatable air tubes at the edges allow the water to simply flow past and the inside of the tent remains dry.

Water protection tarpaulin, color grey

Wide	Length	Weight	Grey	Price
2,5 m	2,5 m	3,1 kg	904467	44,95
2,5 m	3,0 m	3,6 kg	90446	55,95
2,5 m	4,0 m	4,5 kg	904465	73,95
2,5 m	5,0 m	5,4 kg	904466	79,95
3,0 m	4,0 m	5,1 kg	904468	54,95
3,0 m	5,0 m	6,1 kg	904469	64,95



Caution: Do not overfill the air hoses



Tarpaulin - Tent floor carpet pad or all-purpose tarpaulin

- Eyelets at 1 meter intervals
- Waterproof and UV-stabilized
- Reinforced corners

Versatile use as a tarpaulin for protection or as a tent floor. PE fabric 170 g/sqm.

Color: Blue

4 x 5 m	Weight: 3,6 kg	90653	19,50
4 x 6 m	Weight: 4,4 kg	90654	29,95
5 x 6 m	Weight: 5,5 kg	90655	37,95

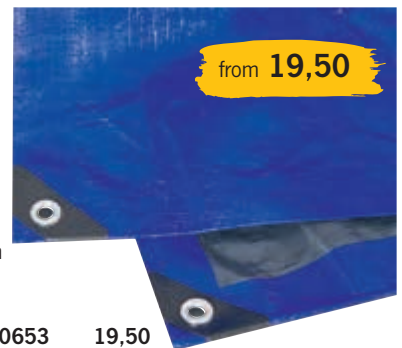

All-purpose tarpaulins

Versatile tarpaulin, e.g. as a tarpaulin to protect against dirt and rain or as a windbreak. Size suitable as carpet pad for tent carpets. With welded-in reinforcement cord and reinforced corners. Waterproof and UV-stabilized. Easy to attach to the floor with carpet clamps 904489.

Material: PE fabric 125g/m2 Color: Gray

Dimensions:

2 x 3 m	90660	9,95
3 x 3 m	90661	13,50
3 x 4 m	90662	15,50
3 x 5 m	90656	14,95
3 x 6 m	90657	16,95
3 x 7 m	90658	17,95
3 x 8 m	90659	18,95

Floor tiles – 60 x 60 cm

4
PIECES

20,90

- Universally applicable
- Including corner strips
- Soft, shock-absorbing material
- Mounted quickly

For tents, awnings, playgrounds, hobby rooms, children's rooms, etc.

No more cold & wet feet. Soft, shock-absorbing and insulating material. Can be cut to size with scissors or a knife.

Material: EVA

4 tiles and 8 corner strips	90445	20,90
-----------------------------	-------	-------



4,50

Fixing clips - set of 4

For attaching carpets, awnings, tarps and much more. Simply clip in, close and secure. For material thickness up to max. 1.2 cm

Material: PP. Dims.: L8.5 x W3 cm

4 piece



904489

4,50

WITHOUT TARPAULIN AND PEGS

Plastic tent / tarp nails – 6 pieces

6
PIECES

- With a broad head
- For fastening tent carpets, floors, tarpaulins, etc.
- Simply insert through eyelets
- No more tripping hazards and risk of injury

Color: Gray

Material: Plastic

Dimensions: 8 cm

6 piece

902801

2,40





Camping Know How

The tent skin:

Synthetic fiber or cotton?

Today, modern synthetic fiber fabrics are almost exclusively used for travel tents due to their excellent waterproofness and stability combined with low weight and pack size. Disadvantage is their lower breathability (w/ exception of acrylic fabrics) & poorer light resistance, but this is of little consequence when they are normally used as vacation tents. The fabrics can be given a UV protective coating to increase their lightfastness.

Polyester UV-resistant

Extremely stable and hardly any wear. Long shelf life. Comparatively resistant to solar radiation. Low water absorption, moisture remains on surface of material & hardly penetrates fibers. Very fast drying.

Polyester PU-coated (coated)

Even more water-repellent and quick-drying.

Polyester Ripstop

Polyester fabric w/ reinforced "grid inserts", particularly tear-resistant. Oxford polyester, e.g. 150D. Woven polyester fibers are more stable and tear-resistant. Used for extremely high-quality tents. Reimo tents are mainly made of ripstop polyester or Oxford polyester. For long durability with low weight

PE or polyethylene

For tent floors or rotting strips. Long, thin "plastic strands" are woven together and laminated on both sides with liquid polyethylene. Abrasion and mildew resistant, UV resistant.

PVC fabric

Extremely heavy, waterproof and hard-wearing fabric, sometimes used for tent roofs or sewing strips.

Cotton

Breathable, allows water and air to pass through. Moisture is absorbed, the individual fibers swell and the fabric becomes dense. Cotton usually only achieves an impermeability of around 300 mm water column. Due to its high weight, sensitivity and long drying time, it is rarely used.

Polycotton

Breathable blended fabric made from polyester and cotton. Lighter and more water-repellent than pure cotton. But compared to polyester, it is considerably heavier and not as waterproof.

Acrylic

Modern hi-tech synthetic fiber fabric w/ breathability similar to cotton tents. Only used for very high-quality tents.

Seam sealing - Seam Taping

Tents made of synthetic fiber fabric leak at seams first. To seal polyester tents, special, high-quality PU sealing tape is pressed onto the inside of the seams using heat and pressure. This makes them completely water-repellent. In the event of damage, liquid seam sealants can be used for sealing. Seam sealing is not so critical with nylon tents (usually double roof tents). They are sewn with polyester threads with a cotton coating that swells and seals. With cotton tents, seam itself usually swells.

Flame retardancy

Tent fabrics are naturally sensitive to fire. They can be given a flame-retardant coating to improve their properties.

Condensation water tightness

Modern fabrics are usually extremely waterproof. As a result, the moisture in the breathing air or room air condenses on the interior walls. The only remedy is good ventilation. The following rule applies: the greater the temperature difference between outside and inside, the more ventilation is required. The effect can also be reduced by using a thermal canopy made of cotton fabric, which can store moisture and therefore has a balancing effect.

The tent poles:

Steel frame

Very stable. In the case of a simple design, only painted; galvanizing offers better rust protection. Important is a very good stiffening of corner angle tent parts w/ rubber, cords or chains. Color markings or numbering facilitate the structure.

Aluminum poles

About 50% lighter than steel. For sufficient stability, usually stronger than steel poles. Stowage volume is about the same.

Fiberglass poles

Used for modern dome or tunnel tents. Manufactured from fibers bonded w/ resin. Highly flexible, elastic and always returns to its original position. Bars of any length can be assembled from individual elements. Elastic rope connections facilitate assembly. Extremely durable, heavier than aluminum.

Aluminum poles for high-tech tents

Used for special high mountain tents. Mostly made of aircraft aluminum, high-strength and very light. Due to the high material costs, they are only worth using where particularly low weight or very high strength is required.

Air hoses

Inflatable awnings are becoming more and more important. An inflatable tent is set up and ready for use in no time. The cumbersome handling with the tent poles is eliminated. Simply inflate with an air pump 7 psi pressure and the tent stands stable and reliable.

Then attach the awning to the roof rail or piping, stretch a few storm lines and anchor it storm-proof with the guy ropes and pegs.

The waterproof and tearproof materials are also convincing. Both hoses and sheathing withstand even hard use without any problems.

Tent components:

Guy ropes Should have a light color so that they are visible in the dark. Leashes with woven-in reflective strips that reflect light in the dark like a cat's eyes are ideal.

Zipper covers Hardly any zipper is waterproof. They should therefore be covered with a fabric flap that can be secured with Velcro.

Tent windows Windows with mosquito netting provide good ventilation, but must be closed in the rain if the cover cannot be stretched over them for protection. Screens over the windows protect the rolled-up cover from dirt and water. Curtains in front of the large transparent windows protect your privacy. Choose between tents with tinted or transparent windows.

Set-up bars

Most tents are supplied with additional poles. These allow the front or side doors to be set up as awnings.

Quality is the sum of good details



MATERIAL

Most REIMO TENT TECHNOLOGY awnings are made of high-quality Ribstop polyester and are mostly manufactured in factories that are also known for their high quality production.

An additional coating provides the necessary UV protection, as well as all tents are flame retardant.

The waterproofness is at a water column of 2,000 to 3,000 mm.



SCOPE OF DELIVERY

All REIMO TENT TECHNOLOGY tents are supplied with pegs, guy ropes and poles/air tubes. Conveniently packed in a carry bag. All air tents come with a double air pump.

Additional delivery such as tent floor, roof reinforcement, wind deflector, sky, etc. is mentioned separately with the respective article.



SPECIAL FEATURES

Inflatable awnings are becoming more and more important. An inflatable tent is set up and ready for use in no time. The cumbersome handling with the tent poles is eliminated. Simply inflate with an air pump 7 psi pressure and the tent stands stable and reliable.

Then attach the awning to the roof rail or piping, stretch a few storm lines and anchor it storm-proof with the guy ropes and pegs.

The waterproof and tearproof materials are also convincing. Both hoses and sheathing withstand even hard use without any problems.

FASTENING TO THE VEHICLE



Vehicles with Multirail or rain gutter

The ideal attachment is by means of Multirail. You can decide here whether to fix the awning with a clamping pole/lock pole or with keder profile. The lock pole is pushed into the tunnel of the awning and then fixed to the Multirail or another suitable rain gutter with clamping clips. Keder profiles from 5.8 mm to 8 mm in diameter can be inserted into the Multirail.



The most practical solution is to attach the awning to the vehicle using a double keder rail. The keder rail as well as the keder profile allow the awning to remain standing when the vehicle is moved away



Retrofitting rain gutters

For attaching van awnings and sun canopies to vehicles without rain gutters, the Universal Kombi rain gutter provides protection against rainwater run-off and accommodates the piping of the awning or sun canopy in the piping profile.

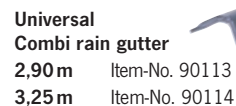

Vehicles without rain gutter

Fastening of awnings by clamping pole/rail bar. In order to attach a clamping pole to the vehicle even without a rain gutter, folding suction cups are available. With 2 folding suction cups you can fix a clamping pole on the roof by clamping the pole into the folding suction cup.

For the folding suction cup you need a clean, even and dry roof surface, the attachment is done without drilling.



Folding vacuum cleaner
Item-No. 93646



Fastening with loops or guy ropes

The folding suction cup is recommended for fastening awnings, canopies and awnings with sewn-on loops or guy lines without screws. For the folding suction cup you need a clean, even and dry roof surface. A very strong vacuum is created by flipping the lever.

Folding suction cup
Item-No. 936471



Fastening awnings with a magnetic adapter

The magnetic adapter offers an even faster way of attaching to the vehicle roof. It adheres to flat vehicle roofs and is connected to the awning with piping and connector profiles. Attention: A magnetic adapter does not hold on GRP high or sleeping roofs!



Magnet adapter Item-No. 904490 S. 63

WARRANTY CONDITIONS

We provide a manufacturer's warranty for all products offered under the following Reimo brands:

“CARBEST” / “REIMO TENT” / “MC CAMPING” / “CAMP4” / “HOLIDAY TRAVEL”

WARRANTY CONDITIONS:

Reimo Reisemobil-Center GmbH, Boschring 10, D-63329 Egelsbach (hereinafter referred to as “Reimo” or “we”), provides a three-year warranty on the products sold under its own “CARBEST”, “REIMO TENT”, “CAMP4” and “HOLIDAY TRAVEL” brands in addition to the statutory rights related to defects.

By way of derogation from the above, Reimo provides a seven-year warranty on LiFePO4 lithium batteries sold under its own “CARBEST” brand and a five-year warranty on those sold under its own “MC CAMPING” brand.

In addition, Reimo provides a 25-year warranty on rigid solar panels with aluminium frames sold under the “CARBEST” brand and a 20-year warranty on those sold under the “MC CAMPING” brand.

The warranty period will start to run on the relevant invoice date. The geographical scope of our warranty extends to the territory of the Federal Republic of Germany.

If any material defects or manufacturing defects are found in your purchased products during the warranty period, we will provide you with one of the following services at our discretion as part of the warranty:

- **We will repair the goods free of charge; or**
- **We will exchange the goods for an equivalent product free of charge.**

Reimo will acquire ownership of any original parts that are replaced within the scope of the above warranty services.

You will acquire ownership of the new parts or replacement parts.

Any repairs or replacements provided under the warranty will not entitle you to extend or restart the relevant warranty period.

If you wish to make a warranty claim, please contact the dealer from whom you purchased the product in question or Reimo directly as the warrantor:

Reimo Reisemobil-Center GmbH
Boschring 10
D-63329 Egelsbach
Tel.: +49 6150 8662-310

The warranty will not apply if any defects other than material defects or manufacturing defects are found.

Furthermore, warranty claims will be rejected if any damage is caused by:

- **normal wear and tear;**
- **improper and non-intended use of the product;**
- **improper operation, installation, assembly, commissioning or operation contrary to the relevant instructions for use and/or installation, especially if instructions for maintenance and care or warnings are not observed;**
- **failure to observe any safety precautions;**
- **use of force (e.g. beating);**
- **self-repairs;**
- **use of any non-original parts or any parts not approved by the manufacturer;**
- **environmental factors (e.g. heat, humidity);**
- **circumstances for which the manufacturer is not responsible (e.g. natural disasters, accidents); or**
- **improper transportation.**

In order to make a warranty claim, you must allow us to examine the case in question (e.g. by sending us the goods).

Please use secure packaging to ensure that the goods are not damaged during transport.

In order to make a warranty claim, you must enclose a copy of the invoice with the shipment of the goods. This will enable us to check whether the warranty conditions are met. If you do not enclose a copy of the invoice, we may refuse to provide services under the warranty.

If your warranty claim is legitimate, you will not incur any shipping costs (i.e. we will reimburse you for any shipping costs incurred to send us the goods).

Please note:

This manufacturer's warranty provided by Reimo will not restrict any statutory warranty rights that you may be able to assert against Reimo / a dealer in the event of defects;

you may exercise the relevant rights free of charge.

This manufacturer's warranty shall have no bearing on any statutory warranty rights that you may hold against Reimo. On the contrary, this manufacturer's warranty serves to consolidate your legal position.

If any of your purchased items are defective, you may always assert your statutory warranty rights against Reimo, regardless of whether the defects are covered by the warranty or whether a claim is asserted under the warranty.



(Last updated: December 2023 / Rev.1.3_11.2023)

TERMS AND CONDITIONS

- Scope**
 - The deliveries and services of Reimo Reisemobil-Center GmbH are subject to the following terms and conditions. Our terms and conditions apply exclusively. Any deviating, conflicting or supplementary terms and conditions of the customer shall not apply, unless we explicitly approve their validity. This applies even if we unreservedly provide the customer with a delivery or service despite being aware of the customer's terms and conditions.
 - Unless explicitly stated otherwise in the following clauses, these terms and conditions apply both to "traders", as defined in Section 14 of the German Civil Code (BGB), and to legal persons incorporated under public law or investment funds incorporated under public law, as well as to "consumers", as defined in Section 13 BGB. A "consumer" means any natural person who enters into a legal transaction for purposes that predominantly are outside the consumer's trade, business or profession. A "trader" means a natural or legal person or a partnership with legal personality who or which, when concluding a legal transaction, acts in exercise of their trade, business or profession.
 - Conclusion of Contract**
 - Our offers shall be subject to change. If the customer makes an offer to enter into a contract by placing an order, the relevant contract shall only be established when we accept the offer.
 - If an order is placed via our website (www.reimo.de), the following provisions shall apply to the conclusion of the contract in addition to those specified in Section 2.1 above:
 - The presentation of items on our website shall not constitute a binding offer. The customer may select goods on our website and place them in the virtual shopping cart by clicking on the shopping cart symbol. By clicking on the "Buy now" button, the customer shall make a binding offer to purchase the goods in the shopping cart. The customer may view and change the relevant data at any time before submitting the order.
 - The customer shall receive an automated email from us to confirm receipt of the order. The automatic confirmation of receipt shall merely document the fact that we have received the customer's order; it shall not mean that we accept the customer's offer to enter into a contract. The contract shall only be established when we submit a declaration of acceptance, which shall be sent as an order confirmation in a separate email. Any contracts facilitated via our website shall be concluded in German.
 - All agreements made between us and the customer when entering into the contract shall be fully documented in writing in the contract, including these terms and conditions. Our employees shall not be authorised to make any verbal agreements that deviate from the contract or supplement its provisions.
 - We reserve the right to make insignificant changes to components, the design, the colour or other details as part of technical developments, provided such changes are reasonable for the customer, taking into account the interests of both parties. In particular, any such changes must not lead to a reduction in value or an impairment of use.
 - Due to the use of natural raw materials, all weight specifications shall be within the usual tolerances of +/- 5%.
 - Prices and Terms of Payment**
 - Prices and terms of payment for contracts with consumers
 - The prices indicated for consumers in our online shop and any other prices offered to consumers shall be gross prices quoted in EUROS ex works plus any additional shipping costs that may be indicated. If an order is placed via our website, the respective shipping costs shall be specified in our online shop.
 - If a consumer places an order via our online shop, we shall offer the following payment methods: PayPal, credit card (MasterCard or Visa) or *Sofortüberweisung*. If we enter into a contract with a consumer in a brick-and-mortar shop, the purchase price must be paid in cash or by EC card upon delivery.
 - Prices and terms of payment for contracts with traders
 - If we make a trader an offer, the prices offered shall be net prices quoted in EUROS ex works, unless stated otherwise. If applicable, the statutory rate of value added tax shall be shown separately on our invoice.
 - The following terms of payment apply to contracts with traders: Our invoices shall be payable without deductions within 30 days of receipt. If payment is received within 8 days of invoicing, we shall grant a 2% discount for early payment. We shall grant a 3% discount for cash payments, advance payments and successful payment collection based on a SEPA direct debit mandate.
 - General terms of payment for consumers and traders
Regardless of whether the customer is a consumer or a trader, the following terms of payment shall also apply:
 - If the customer defaults on payment, we shall be entitled to charge default interest at the applicable statutory rate. We also reserve the right to assert further claims due to the delay.
 - The customer shall only be entitled to offset our claims against the customer's own counterclaims – or assert a right of retention – if the customer's counterclaims are legally established, undisputed or recognised by us. However, this restriction does not apply to any counterclaims held by the customer due to defects or the partial non-fulfilment of the contract, provided the claims are based on the same contractual relationship as our claims. The right to offset any claims arising from the exercise of the consumer's right of withdrawal, as described in Section 13 below, also remains unaffected.
 - If it becomes apparent that our claim to the purchase price is jeopardised by the customer's solvency after entering into the contract, we shall be entitled to refuse performance in accordance with the statutory provisions and, if the customer neither pays the purchase price nor provides security within a reasonable period set by us, we shall be entitled to withdraw from the contract (Section 321 BGB).
 - In the case of contracts for the delivery of complete vehicles, the following also applies: If a delivery date is agreed more than four months after the conclusion of the contract, and if our suppliers increase their prices during this period after the conclusion of the contract for reasons not attributable to us, we shall be entitled to pass on these increased costs to the customer and to adjust our price accordingly. We shall immediately inform the customer.
 - Delivery and Service Deadlines**
 - We shall only adhere to our delivery and service deadlines if the customer properly fulfils their own obligations in a timely manner.
 - Any events for which we are not responsible and which prevent us from providing our services (e.g. strikes, lawful lockouts, official orders, natural disasters and other examples of force majeure) shall release us from our contractual obligations as long as the hindrance persists. We agree to inform the customer immediately about the occurrence and expected duration of such events. If such an event persists for longer than three months, each party shall be entitled to withdraw from the contract. In such cases, any consideration that has already been provided shall be refunded immediately.
 - If we default on a delivery or service due to slight negligence, our obligation to compensate for any damage caused by the delay (compensation in addition to performance) shall be limited to a maximum of 5% of the net purchase price of the delayed delivery or service. Our liability for culpable injury to life, limb or health remains unaffected. Our liability for compensation in lieu of performance shall be governed by the provisions of Section 5 of these terms and conditions.
 - The delivery of goods is also subject to the provisions of Section 8 (see Part II below).
 - Liability**
 - We shall be liable in accordance with the statutory provisions if the customer asserts any claims for damages based on intent or gross negligence – including intent or gross negligence on the part of our legal representatives, employees or other vicarious agents – or based on the culpable breach of an essential contractual duty. Essential contractual duties are those which must be observed to achieve the purpose of the contract and on the observance of which the customer may regularly depend. If we are not guilty of intent or gross negligence, our liability for damages in the above cases shall be limited to the foreseeable degree of damage that typically occurs.
 - In the case of liability for culpable injury to life, limb or health, the statutory provisions shall remain unaffected; the same applies to cases of mandatory liability under the German Product Liability Act (ProdHaftG).
 - Unless otherwise stipulated above, we shall not be liable for any damages regardless of the legal nature of the claim in question. In case of default, our liability shall also be subject to the limitations described in Section 4.3 above.
 - The above provisions shall apply accordingly if the customer demands compensation of wasted expenses instead of claiming compensation for damages in lieu of performance.
 - If our liability for damages is excluded or limited, this shall also apply with regard to the personal liability of our legal representatives, employees and vicarious agents.
 - Information Provided By Telephone**

Any information provided by telephone shall generally be non-binding and without guarantee if we offer an assessment after the matter in question is described by telephone, verbally or in writing and if we have no opportunity to conduct a detailed inspection of the item to which the information relates.
 - Special Provisions for Deliveries of Vehicles, Accessories and Spare Parts**
 - Special Orders and Custom-Made Vehicles**

A deposit of 25% of the purchase price shall be due when a contract is established for special vehicle orders; a deposit of 40% of the purchase price shall be due when a contract is established for custom-made vehicles. Any custom-made vehicles shall be manufactured according to the plans and measurements provided by the customer. The customer shall be solely responsible for the correctness of such measurements.
 - Delivery and Transfer of Risk**
 - Our deliveries shall be made ex works. The risk of accidental loss or deterioration shall be transferred to the customer, at the latest, when the goods are handed over to the customer. If we ship the goods at the customer's request, the risk shall be transferred to the customer when the goods are handed over to the freight carrier or another person instructed to transport the goods. The statutory transfer of risk in the event of default in acceptance remains unaffected. If the customer is a consumer, the risk in the cases described in the third sentence above shall only be transferred to the customer as soon as the goods are handed over to the freight carrier or another person instructed to transport the goods if the customer has instructed the freight carrier or the other person to carry out the shipping and we have not previously named the transporting person to the customer.
 - Unless stated otherwise, any parts ordered via our website shall be delivered within 5 working days.
 - We shall be entitled to make partial deliveries if they are reasonable for the customer.
 - If the customer requests a different design of the purchased item before it is delivered, the delivery period shall be interrupted until an understanding is reached on the required design; if necessary, the deadline shall be extended by the time required to implement the different design.
 - If an agreed, non-binding delivery date is exceeded by more than 6 weeks in the case of a contract for the delivery of vehicles, the customer shall be entitled to set us a reasonable grace period. If we do not deliver the purchased item by the end of the grace period, the customer may withdraw from the contract by means of a written declaration and/or demand compensation in lieu of performance under the legal requirements.
 - Conditions of Acceptance for the Delivery of Vehicles**
 - If the customer fails to accept a purchased item within 14 days of being notified of its availability, or if the customer refuses to accept the delivery, we shall be entitled to withdraw from the contract and/or to demand compensation due to non-performance after a reasonable grace period set by us.
 - In the latter case, we shall be entitled to claim 15% of the purchase price as compensation for damages – without prejudice to the possibility of demanding a greater amount for the damage that is actually incurred. The customer reserves the right to prove that we have incurred significantly less or no damage.
 - Retention of Title**
 - The goods shall remain our property until the purchase price has been paid in full. By way of derogation from the first sentence, the following shall apply if the customer is a trader: The goods shall remain our property until all claims arising from the business relationship between us and the customer, including any additional claims, have been settled in full. The retention of title shall remain in effect even if some of our claims are included in a current account and the balance has been determined and recognised.
 - The customer shall not be permitted to pledge any goods subject to retention of title or assign them as security. We must be immediately notified of any seizures or other third-party interventions. If the third party is unable to reimburse us for the judicial and extra-judicial costs of averting the intervention in question, the customer shall be liable for the loss we incur.
 - The customer shall store any goods subject to retention of title for us free of charge. The customer must insure them against common risks such as fire, theft and water with the usual degree of coverage. The customer hereby assigns to us any compensation claims held against insurance companies or any other parties liable for compensation due to any damages of the type described above; the assigned claims shall correspond to the amount of the customer's own claims.
 - If the customer fails to meet their payment obligations, we shall be entitled to withdraw from the contract and demand the return of the goods subject to retention of title under the legal requirements.
 - If the customer is a trader, the following provisions also apply:
 - The customer shall be entitled to process and sell any goods subject to retention of title in accordance with the following provisions:
 - The customer hereby assigns to us any claims arising from the resale of goods subject to retention of title corresponding to the final amount invoiced for our own claims (including VAT); this shall also apply proportionately if the goods are processed, mixed or combined with other items and we acquire co-ownership in the amount of their invoice value. In the latter case, we shall be entitled to a fraction of the respective purchase price claim arising from the resale in the ratio of the invoice value of our goods subject to retention of title to the total invoice value of the item in question. If the customer sells the claim as part of factoring, the customer shall assign to us the claim held against the factor that replaces it. We shall accept the assignment.
 - We shall not collect any assigned claims as long as the customer meets their payment obligations. The customer shall remain entitled to collect the claims. However, the customer shall no longer be authorised to collect the claims if the customer defaults on payment or if an application is filed for insolvency proceedings against the customer's assets. In such cases, we may ask the customer to notify us of the assigned claims and the debtors, to provide all information required to collect the receivables, to hand over the associated documents, and to inform the debtors that the claims have been assigned to us.
 - By processing goods subject to retention of title, the customer shall not acquire ownership of the new item pursuant to Section 950 BGB. Any such processing shall be done for us; however, this shall not result in any liabilities for us. If any goods subject to retention of title are processed, mixed or combined with other items, we shall acquire co-ownership of the new item in the ratio of the value of the goods subject to retention of title to the total value of the goods. The customer shall no longer be authorised to process goods subject to retention of title in the ordinary course of business if the customer stops making payments or if an application is filed for insolvency proceedings against the customer's assets.
 - We agree to release the securities to which we are entitled if their value exceeds the claims to be secured by more than 20%. We shall be responsible for choosing the securities to be released.
 - Warranty for Contracts of Sale**
 - If any defects are found in our goods, the customer shall have the statutory warranty rights described in Section 434 *et seq.* BGB; however, the customer shall only be able to assert any claims for damages to the extent specified in Section 5 above.
 - If the customer is a trader, the following provisions also apply:
 - The customer shall only be able to assert any warranty claims after properly fulfilling their obligation to inspect the goods and report defects in accordance with Section 377 of the German Commercial Code (HGB). The customer shall be obliged to inspect the purchased items as soon as they are received. Any defects must be reported immediately. Otherwise, the goods shall be deemed to have been accepted in perfect condition, unless the defect was not apparent during the inspection. Any installed parts shall not be replaced or repaired if damage would have been detected upon careful inspection prior to installation. Any hidden defects that were not apparent during a proper inspection must be reported as soon as they are discovered. Any defects must always be reported in writing.
 - If a purchased item is defective and the defect is properly reported by the customer, we shall be able to choose whether to deliver a replacement or make a repair. We shall acquire ownership of any replaced parts. The place of subsequent performance shall be our registered office. The customer shall only be entitled to withhold payments due to a defect to an extent that is appropriate in relation to the defect and in relation to the cost of rectifying the situation.
 - The customer shall only be entitled to assert any warranty claims if the customer can prove that the goods were defective when the risk was transferred. In particular, we shall not be liable for any damage caused by improper use, incorrect assembly, inadequate or incorrect maintenance, or any damage caused by natural wear and tear or unauthorised changes to purchased items (e.g. self-assembly, installation of equipment and accessories).
 - The warranty period applicable to claims for defects shall be 12 months from the delivery of the item in question. By way of derogation from the above, the statutory warranty period of two years shall apply to any claims for damages due to intentional or grossly negligent breaches of duty or culpable injury to life, limb or health. The statutory limitation period in the case of recourse against the supplier (recourse by a trader) remains unaffected.
 - We shall only assume any guarantees if this is explicitly stated for the selected product. The details of each guarantee can be found in the relevant guarantee conditions. Any guarantees shall apply in addition to statutory warranty rights.
- Agreements on Returns for Traders**

If the customer is a trader, the following applies with regard to returns: Unless there is a warranty claim, any goods may only be returned with our prior, written consent; the returned goods must be accompanied by a copy of the invoice. In such cases, the return shipping costs must be borne by the customer. Unless otherwise agreed, the customer shall also be obliged to pay 15% of the purchase price in such cases.
- Cancellation Right for Consumers**

If the customer is a consumer who enters into a contract with us via our website, the customer shall be entitled to cancel their order under the following conditions:

Cancellation Policy
The customer shall be entitled to cancel the contract within fourteen days without stating their reason for doing so. The fourteen-day cancellation period shall begin on the day the goods are handed over to the customer or a third party designated by the customer, excluding the carrier. In case of a contract for several goods that are requested by the customer as part of a single order and that are delivered separately, the fourteen-day cancellation period shall begin on the day the last goods are handed over to the customer or a third party named by the customer, excluding the carrier.

In order to exercise the cancellation rights described above, the customer must send us a clear statement (e.g. a letter sent by post, fax or email) regarding their decision to withdraw from the contract; we can be contacted as follows: Reimo Reisemobil-Center GmbH, Lieferzentrum, Abt. Retouren, Am Rotball 17-19, D-64331 Weistadt; Fax: +49 6150 8662-329; Tel.: +49 6150 8662367; Email: shop@reimo.com. The customer may use the attached cancellation form template, but this is not mandatory. In order to meet the deadline, the customer must merely submit the statement outlining their intention to cancel the contract before the end of the cancellation period. Ramifications of cancellation:
If the customer cancels the contract, we shall reimburse any payments received from the customer, including shipping costs (except for any additional costs incurred if the customer does not choose our cheap standard shipping); we shall make the refund immediately – and at the latest within fourteen days of receiving notification of their intention to cancel the contract. We shall make the refund with the same payment method used by the customer for the original transaction, unless alternative arrangements are explicitly agreed with the customer, under no circumstances shall the customer be charged any fees for the refund.
We may refuse to make a refund until we have received the returned goods or until the customer has provided evidence to prove that the goods have been returned, whichever comes first.
The customer must return or hand over the goods immediately – and at the latest within fourteen days of notifying us of the cancellation of the contract. The deadline shall be met if the customer sends off the goods before the end of the fourteen-day period.
The costs directly associated with the return shipment shall be borne by the customer. If goods cannot be sent by parcel and cannot be returned normally by post, we shall offer to collect the goods from the customer at our expense.
The customer must only pay for any depreciation of the goods if the loss of value is caused by the use of the goods in a manner that is not necessary to check their quality, properties and functionality.
- Part III. Special Provisions for Services Involving Work Performed on Items Not Procured By Us**
 - Customer's Obligation to Cooperate**
 - If the customer places an order for the provision of services involving work performed on items not procured by us, the customer must make the vehicle available to us at the agreed time in a condition suitable for performing the work.
 - If the vehicle needs to be cleaned before the work specified in the order can be performed, and if the cleaning is done by us, we shall be entitled to invoice the customer for this.
 - In the case of orders involving assembly, the vehicle must be in factory or standard condition and must be delivered in a completely empty state. We shall not be liable for any moving parts found in the vehicle contrary to this agreement, unless the customer can prove that we are guilty of intent or gross negligence. An additional charge shall be incurred for any work required to create or compensate for this condition (e.g. damaged vehicle).
 - In the case of orders involving assembly and repair, the cost estimate may be exceeded by up to 15% if any unforeseen circumstances arise during the work and we are unable to consult the customer at short notice. The customer's rights pursuant to Section 649 BGB shall otherwise remain unaffected.
 - Unless otherwise agreed, we shall immediately dispose of any removed parts for a fee.
 - Collection and Acceptance**
 - The customer shall be obliged to collect the object of the order no later than one week after receiving notification that the order is complete. The customer shall be obliged to formally accept the work performed in accordance with the contract. Unless otherwise agreed, the formal acceptance procedure with the customer shall take place at our registered office. The customer must not refuse acceptance due to insignificant defects.
 - In the event of non-acceptance, we shall be entitled to assert our statutory rights without restriction. In particular, we shall be entitled to charge the usual local storage costs. If the customer defaults on acceptance, the risk shall be transferred to the customer.
 - Warranty for Services Involving Work Performed on Items Not Procured By Us**

If any service involving work performed on items not procured by us proves to be inadequate, the customer shall be able to assert their statutory warranty rights; however, the customer shall only be able to assert any claims for damages to the extent specified in Section 5 above. The warranty period shall be one year from acceptance. By way of derogation from the above, the statutory warranty period shall apply to any claims for damages due to intent, gross negligence or culpable injury to life, limb or health.
 - Final Provisions**
 - Place of Jurisdiction and Applicable Law**

If the customer is a merchant, a legal person incorporated under public law or an investment fund incorporated under public law, the courts at our registered office shall be the place of jurisdiction for any disputes arising from or in connection with the contract. This agreement on the place of jurisdiction applies exclusively to the customer. We shall also be entitled to take legal action against the customer at their general place of jurisdiction.
 - These terms and conditions are subject to the law of the Federal Republic of Germany to the exclusion of the United Nations Convention on Contracts for the International Sale of Goods (CISG). If the customer is a consumer whose habitual residence is located in a country other than Germany at the time the order is placed, however, the application of the mandatory legal provisions of the country in question shall remain unaffected by the choice of law identified in the first sentence.
 - Dispute Resolution in Consumer Contracts**

The European Commission has created an online dispute resolution platform that serves as a point of contact for the out-of-court settlement of disputes with consumers in relation to contractual obligations arising from online contracts. This is available here: <http://ec.europa.eu/consumers/odr/>.
 - We are neither obliged nor willing to participate in dispute resolution proceedings before a consumer arbitration board under the German Act on Alternative Dispute Resolution in Consumer Matters (VSBG).
 - Severability Clause**

If any provisions of these terms and conditions prove to be ineffective, this shall have no bearing on the effectiveness of the remaining provisions. Any ineffective provisions shall be replaced by the statutory provisions.



TENTS + AWNINGS 2024

Copyright by Reimo Reisemobil-Center GmbH.

All prices in € incl. VAT. Delivery subject to change. All products without decoration. Misprints, errors and technical changes / further developments reserved. All data without guarantee. The permissible tolerance for technical data is +/- 5%. Water systems described in the content correspond to the state of the art 10/2007 (Directive 200772/EC). Some illustrations show extras and decorations not included in the scope of delivery or equipment for countries other than Germany. All rights reserved. Reprinting and use in electronic media, including excerpts, only with the express permission of Reimo Reisemobil-Center GmbH, Egelsbach. Status: March 2024.

www.reimo.com

